



**NEXCOM International Co., Ltd.**

# **Intelligent Platform & Services Business Unit**

## **Edge Computing System**

### **Neu-X304 Series**

#### User Manual

# CONTENTS

## Preface

Copyright .....	iv
Disclaimer .....	iv
Acknowledgements .....	iv
Regulatory Compliance Statements .....	iv
Declaration of Conformity .....	iv
RoHS Compliance .....	v
Warranty and RMA .....	vi
Safety Information .....	viii
Installation Recommendations .....	viii
Safety Precautions .....	ix
Technical Support and Assistance .....	x
Conventions Used in this Manual .....	x
Global Service Contact Information .....	xi
Package Contents .....	xiii
Ordering Information .....	xiv

## Chapter 1: Product Introduction

Neu-X304 Series .....	1
Overview .....	1
Key Features .....	1
Hardware Specifications .....	2
Physical Features .....	4
Neu-X304-Q Front Panel .....	4
Neu-X304-Q Rear Panel .....	4

Physical Features .....	5
Neu-X304-H Front Panel .....	5
Neu-X304-H Rear Panel .....	5
Mechanical Dimensions .....	6

## Chapter 2: Jumpers and Connectors

Before You Begin .....	6
Precautions .....	6
Jumper Settings .....	7
Locations of the Jumpers and Connectors for the Neu-X304 Series .....	8
Jumpers & DIP Switches .....	10
Clear CMOS .....	10
COM2 RI Select .....	10
LCD Panel Voltage Select .....	11
Connector Pin Definitions .....	12
External I/O Interfaces .....	12
Mic In Jack .....	12
Line Out Jack .....	12
HDMI® Port .....	13
LAN Port (i219-LM) .....	13
LAN Port (i226-V) .....	14
USB Ports (Neu-X304-Q) .....	14
USB Ports (Neu-X304-H) .....	15
DC-In Power .....	15

Internal I/O Interfaces .....	16
Battery Connector .....	16
COM Ports .....	16
ATX +12V Power Connector .....	17
FAN Connector .....	17
Debug Port/LPC Bus Connector .....	18
GPIO Connectors .....	18
LVDS Inverter Connector .....	19
LVDS/eDP Panel Connector .....	20
M.2 Key B 3042/3052 Connector .....	22
M.2 Key E 2230 Connector .....	24
M.2 Key M 2280 Connector .....	26
System Power Button Connector .....	28
System Reset Button, HDD LED, and Power LED .....	28
SATA Connector .....	29
System Power Button Connector .....	29
Speaker Connector .....	30
FAN Connector .....	30
Internal USB 2.0 Connector .....	31

## Chapter 3: System Setup

Removing the Bottom Cover from the Chassis .....	28
Installing an M.2 SSD Module (M-Key 2280) .....	29
Installing a SO-DIMM Memory Module .....	31
Installing a Wi-Fi Module (M.2 Key E) .....	32
Installing a 5G/LTE Module (M.2 Key B) .....	34
Installing a CPU .....	36
Wall Mounting Instructions .....	39

## Chapter 4: BIOS Setup

About BIOS Setup .....	38
When to Configure the BIOS .....	38
Default Configuration .....	39
Entering Setup .....	39
Legends .....	39
BIOS Setup Utility .....	41
Main .....	41
Advanced .....	42
Security .....	52
Boot .....	53
Save & Exit .....	54
MEBx .....	55

## Appendix A: Power Consumption

## Appendix B: GPI/O Programming Guide

NCT6126D GPI/O Programming Guide (PCB A) .....	65
--	----

## Appendix C: Watchdog Timer Setting

# PREFACE

## Copyright

This publication, including all photographs, illustrations and software, is protected under international copyright laws, with all rights reserved. No part of this manual may be reproduced, copied, translated or transmitted in any form or by any means without the prior written consent from NEXCOM International Co., Ltd.

## Disclaimer

The information in this document is subject to change without prior notice and does not represent commitment from NEXCOM International Co., Ltd. However, users may update their knowledge of any product in use by constantly checking its manual posted on our website: <http://www.nexcom.com>. NEXCOM shall not be liable for direct, indirect, special, incidental, or consequential damages arising out of the use of any product, nor for any infringements upon the rights of third parties, which may result from such use. Any implied warranties of merchantability or fitness for any particular purpose is also disclaimed.

## Acknowledgements

Neu-X304 is a trademark of NEXCOM International Co., Ltd. All other product names mentioned herein are registered trademarks of their respective owners.

## Regulatory Compliance Statements

This section provides the FCC compliance statement for Class A devices and describes how to keep the system CE compliant.

## Declaration of Conformity

### FCC

This equipment has been tested and verified to comply with the limits for a Class A digital device, pursuant to Part 15 of FCC Rules. These limits are designed to provide reasonable protection against harmful interference when the equipment is operated in a commercial environment. This equipment generates, uses, and can radiate radio frequency energy and, if not installed and used in accordance with the instructions, may cause harmful interference to radio communications. Operation of this equipment in a residential area (domestic environment) is likely to cause harmful interference, in which case the user will be required to correct the interference (take adequate measures) at their own expense.

### CE

The product(s) described in this manual complies with all applicable European Union (CE) directives if it has a CE marking. For computer systems to remain CE compliant, only CE-compliant parts may be used. Maintaining CE compliance also requires proper cable and cabling techniques.

## RoHS Compliance



### **NEXCOM RoHS Environmental Policy and Status Update**

NEXCOM is a global citizen for building the digital infrastructure. We are committed to providing green products and services, which are compliant with European Union RoHS (Restriction on Use of Hazardous Substance in Electronic Equipment) directive 2011/65/EU, to be your trusted green partner and to protect our environment.

RoHS restricts the use of Lead (Pb) < 0.1% or 1,000ppm, Mercury (Hg) < 0.1% or 1,000ppm, Cadmium (Cd) < 0.01% or 100ppm, Hexavalent Chromium (Cr6+) < 0.1% or 1,000ppm, Polybrominated biphenyls (PBB) < 0.1% or 1,000ppm, and Polybrominated diphenyl Ethers (PBDE) < 0.1% or 1,000ppm.

In order to meet the RoHS compliant directives, NEXCOM has established an engineering and manufacturing task force to implement the introduction of green products. The task force will ensure that we follow the standard NEXCOM development procedure and that all the new RoHS components and new manufacturing processes maintain the highest industry quality levels for which NEXCOM are renowned.

The model selection criteria will be based on market demand. Vendors and suppliers will ensure that all designed components will be RoHS compliant.

### **How to recognize NEXCOM RoHS Products?**

For existing products where there are non-RoHS and RoHS versions, the suffix "(LF)" will be added to the compliant product name.

All new product models launched after January 2013 will be RoHS compliant. They will use the usual NEXCOM naming convention.

## Warranty and RMA

### NEXCOM Warranty Period

NEXCOM manufactures products that are new or equivalent to new in accordance with industry standard. NEXCOM warrants that products will be free from defect in material and workmanship for 2 years, beginning on the date of invoice by NEXCOM.

### NEXCOM Return Merchandise Authorization (RMA)

- Customers shall enclose the “NEXCOM RMA Service Form” with the returned packages.
- Customers must collect all the information about the problems encountered and note anything abnormal or, print out any on-screen messages, and describe the problems on the “NEXCOM RMA Service Form” for the RMA number apply process.
- Customers can send back the faulty products with or without accessories (manuals, cable, etc.) and any components from the card, such as CPU and RAM. If the components were suspected as part of the problems, please note clearly which components are included. Otherwise, NEXCOM is not responsible for the devices/parts.
- Customers are responsible for the safe packaging of defective products, making sure it is durable enough to be resistant against further damage and deterioration during transportation. In case of damages occurred during transportation, the repair is treated as “Out of Warranty.”
- Any products returned by NEXCOM to other locations besides the customers’ site will bear an extra charge and will be billed to the customer.

### Repair Service Charges for Out-of-Warranty Products

NEXCOM will charge for out-of-warranty products in two categories, one is basic diagnostic fee and another is component (product) fee.

#### System Level

- Component fee: NEXCOM will only charge for main components such as SMD chip, BGA chip, etc. Passive components will be repaired for free, ex: resistor, capacitor.
- Items will be replaced with NEXCOM products if the original one cannot be repaired. Ex: motherboard, power supply, etc.
- Replace with 3rd party products if needed.
- If RMA goods can not be repaired, NEXCOM will return it to the customer without any charge.

#### Board Level

- Component fee: NEXCOM will only charge for main components, such as SMD chip, BGA chip, etc. Passive components will be repaired for free, ex: resistors, capacitors.
- If RMA goods can not be repaired, NEXCOM will return it to the customer without any charge.

## Warnings

Read and adhere to all warnings, cautions, and notices in this guide and the documentation supplied with the chassis, power supply, and accessory modules. If the instructions for the chassis and power supply are inconsistent with these instructions or the instructions for accessory modules, contact the supplier to find out how you can ensure that your computer meets safety and regulatory requirements.

## Cautions

Electrostatic discharge (ESD) can damage system components. Do the described procedures only at an ESD workstation. If no such station is available, you can provide some ESD protection by wearing an antistatic wrist strap and attaching it to a metal part of the computer chassis.

## Safety Information

Before installing and using the device, note the following precautions:

- Read all instructions carefully.
- Do not place the unit on an unstable surface, cart, or stand.
- Follow all warnings and cautions in this manual.
- When replacing parts, ensure that your service technician uses parts specified by the manufacturer.
- Avoid using the system near water, in direct sunlight, or near a heating device.
- The load of the system unit does not solely rely for support from the rackmounts located on the sides. Firm support from the bottom is highly necessary in order to provide balance stability.
- The computer is provided with a battery-powered real-time clock circuit. There is a danger of explosion if battery is incorrectly replaced. Replace only with the same or equivalent type recommended by the manufacturer. Discard used batteries according to the manufacturer's instructions.

## Installation Recommendations

Ensure you have a stable, clean working environment. Dust and dirt can get into components and cause a malfunction. Use containers to keep small components separated.

Adequate lighting and proper tools can prevent you from accidentally damaging the internal components. Most of the procedures that follow require only a few simple tools, including the following:

- A Philips screwdriver
- A flat-tipped screwdriver
- A grounding strap
- An anti-static pad

Using your fingers can disconnect most of the connections. It is recommended that you do not use needle-nose pliers to disconnect connections as these can damage the soft metal or plastic parts of the connectors.



## Safety Precautions

1. Read these safety instructions carefully.
2. Keep this User Manual for later reference.
3. Disconnect this equipment from any AC outlet before cleaning. Use a damp cloth. Do not use liquid or spray detergents for cleaning.
4. For plug-in equipment, the power outlet socket must be located near the equipment and must be easily accessible.
5. Keep this equipment away from humidity.
6. Put this equipment on a stable surface during installation. Dropping it or letting it fall may cause damage.
7. The openings on the enclosure are for air convection to protect the equipment from overheating. DO NOT COVER THE OPENINGS.
8. Make sure the voltage of the power source is correct before connecting the equipment to the power outlet.
9. Place the power cord in a way so that people will not step on it. Do not place anything on top of the power cord. Use a power cord that has been approved for use with the product and that it matches the voltage and current marked on the product's electrical range label. The voltage and current rating of the cord must be greater than the voltage and current rating marked on the product.
10. All cautions and warnings on the equipment should be noted.
11. If the equipment is not used for a long time, disconnect it from the power source to avoid damage by transient overvoltage.
12. Never pour any liquid into an opening. This may cause fire or electrical shock.
13. Never open the equipment. For safety reasons, the equipment should be opened only by qualified service personnel.
14. If one of the following situations arises, get the equipment checked by service personnel:
  - a. The power cord or plug is damaged.
  - b. Liquid has penetrated into the equipment.
  - c. The equipment has been exposed to moisture.
  - d. The equipment does not work well, or you cannot get it to work according to the user's manual.
  - e. The equipment has been dropped and damaged.
  - f. The equipment has obvious signs of breakage.
15. Do not place heavy objects on the equipment.
16. The unit uses a three-wire ground cable which is equipped with a third pin to ground the unit and prevent electric shock. Do not defeat the purpose of this pin. If your outlet does not support this kind of plug, contact your electrician to replace your obsolete outlet.
17. **CAUTION:** DANGER OF EXPLOSION IF BATTERY IS INCORRECTLY REPLACED. REPLACE ONLY WITH THE SAME OR EQUIVALENT TYPE RECOMMENDED BY THE MANUFACTURER. DISCARD USED BATTERIES ACCORDING TO THE MANUFACTURER'S INSTRUCTIONS.
18. Ensure to connect the power cord of the power adapter to a socket-outlet with earthing connection.
19. This product is intended to be supplied by a Listed Power Adapter or DC power source, rated 12Vdc, minimum 8A, minimum T ma=45 degree C, minimum altitude of operation=2000m, and evaluated in accordance to UL/IEC 60950-1 and/or UL/IEC 62368-1. If further assistance is needed, please contact NEXCOM International Co., Ltd. (UL file owner or brand owner) for further information.

## Technical Support and Assistance

1. For the most updated information of NEXCOM products, visit NEXCOM's website at [www.nexcom.com](http://www.nexcom.com).
2. For technical issues that require contacting our technical support team or sales representative, please have the following information ready before calling:
  - Product name and serial number
  - Detailed information of the peripheral devices
  - Detailed information of the installed software (operating system, version, application software, etc.)
  - A complete description of the problem
  - The exact wordings of the error messages

### Warning!

1. Handling the unit: carry the unit with both hands and handle it with care.
2. Maintenance: to keep the unit clean, use only approved cleaning products or clean with a dry cloth.

## Conventions Used in this Manual



### Warning:

Information about certain situations, which if not observed, can cause personal injury. This will prevent injury to yourself when performing a task.



### Caution:

Information to avoid damaging components or losing data.



### Note:

Provides additional information to complete a task easily.

## Global Service Contact Information

### Headquarters

#### NEXCOM International Co., Ltd.

9F, No. 920, Zhongzheng Rd.,  
Zhonghe District, New Taipei City, 23586,  
Taiwan, R.O.C.  
Tel: +886-2-8226-7786  
Fax: +886-2-8226-7782  
www.nexcom.com

### Asia

#### Taiwan

#### NexAIoT Headquarters

#### Industry 4.0 and Cloud Services

12F, No.922, Zhongzheng Rd.,  
Zhonghe District, New Taipei City,  
23586, Taiwan, R.O.C.  
Tel: +886-2-8226-7796  
Fax: +886-2-8226-7926  
Email: sales@nexaiot.com  
www.nexaiot.com

#### NexAIoT Co., Ltd.

#### Taichung Office

16F, No.250, Sec.2, Chongde Rd.,  
Beitun District,  
Taichung City, 406, Taiwan, R.O.C.  
Tel: +886-4-2249-1179  
Fax: +886-4-2249-1172  
Email: jacobhuang@nexaiot.com  
www.nexaiot.com

#### NexCOBOT Taiwan Co., Ltd.

13F, No.916, Zhongzheng Rd.,  
Zhonghe District,  
New Taipei City, 23586, Taiwan, R.O.C.  
Tel: +886-2-8226-7786  
Fax: +886-2-8226-7926  
Email: jennyshern@nexcobot.com  
www.nexcobot.com

#### GreenBase Technology Corp.

13F, No.922, Zhongzheng Rd.,  
Zhonghe District,  
New Taipei City, 23586, Taiwan, R.O.C.  
Tel: +886-2-8226-7786  
Fax: +886-2-8226-7900  
Email: vivianlin@nexcom.com.tw  
www.nexcom.com.tw

#### DivioTec Inc.

19F-1A, No.97, Sec.4, ChongXin Rd.,  
Sancong District,  
New Taipei City, 24161, Taiwan, R.O.C.  
Tel: +886-2-8976-3077  
Email: sales@diviotec.com  
www.diviotec.com

#### AIoT Cloud Corp.

13F, No.922, Zhongzheng Rd.,  
Zhonghe District,  
New Taipei City, 23586, Taiwan, R.O.C.  
Tel: +886-2-8226-7786  
Fax: +886-2-8226-7782  
Email: alantsai@aiotcloud.net  
www.aiotcloud.dev

#### EMBUX TECHNOLOGY CO., LTD.

13F, No.916, Zhongzheng Rd.,  
Zhonghe District,  
New Taipei City, 23586, Taiwan, R.O.C.  
Tel: +886-2-8226-7786  
Fax: +886-2-8226-7782  
Email: info@embux.com  
www.embux.com

#### TMR TECHNOLOGIES CO., LTD.

13F, No.916, Zhongzheng Rd.,  
Zhonghe District,  
New Taipei City, 23586, Taiwan, R.O.C.  
Tel: +886-2-8226-7786  
Fax: +886-2-8226-7782  
Email: services@tmrtek.com  
www.tmrtek.com

## China NEXSEC Incorporated

201, Floor 2, Unit 2, Building 15, Yard 3,  
Gaolizhang Road, Haidian District,  
Beijing, 100094, China  
Tel: +86-10-5704-2680  
Fax: +86-10-5704-2681  
Email: marketing@nexsec.cn  
www.nexsec.cn

## NEXCOM Shanghai

Room 406-407, Building C, No 154, Lane 953,  
Jianchuan Road, Minhang District,  
Shanghai, 201108, China  
Tel: +86-21-5278-5868  
Fax: +86-21-3251-6358  
Email: sales@nexcom.cn  
www.nexcom.cn

## NEXCOM Surveillance Technology Corp.

Floor 8, Building B3, Xiufeng Industrial Zone,  
GanKeng Community, Buji Street,  
LongGang District,  
ShenZhen, 518112, China  
Tel: +86-755-8364-7768  
Fax: +86-755-8364-7738  
Email: steveyang@nexcom.com.tw  
www.nexcom.cn

## NEXGOL Chongqing

1st Building No.999,  
Star Boulevard, Yongchuan Dist,  
Chongqing City, 402160, China  
Tel: +86-23-4960-9080  
Fax: +86-23-4966-5855  
Email: sales@nexgol.com.cn  
www.nexcom.cn

## Beijing NexGemo Technology Co.,Ltd.

Room 205, No.1, Fazhan Rd.,  
Beijing International Information Industry Base,  
Changping District,  
Beijing, 102206, China  
Tel: +86-10-8072-2025  
Fax: +86-10-8072-2022  
Email: sales@nexgemo.cn  
www.nexgemo.com

## Japan

### NEXCOM Japan

9F, Tamachi Hara Bldg.,  
4-11-5, Shiba Minato-ku,  
Tokyo, 108-0014, Japan  
Tel: +81-3-5419-7830  
Fax: +81-3-5419-7832  
Email: sales@nexcom-jp.com  
www.nexcom-jp.com

## America

### USA NEXCOM USA

46665 Fremont Blvd.,  
Fremont CA 94538, USA  
Tel: +1-510-656-2248  
Fax: +1-510-656-2158  
Email: sales@nexcom.com  
www.nexcomusa.com

## Package Contents

Before continuing, verify that the Neu-X304 package that you received is complete. Your package should have all the items listed in the following table.

Item	Part Number	Qty
1	Neu-X304 System	1
2	Power Adapter	1

Item	Part Number	Name	Description	Qty
1	5090000001X00	THERMAL GREASE For CPU	T-GLOBAL:TG-S808 1ml	1
2	5060200715X00	Thermal Pad For Memory	60x20x1.5mm K=3.5W/mk	2
3	5060200706X00	Thermal Pad for M.2 Storage	60x20x2mm K=3.5W/mk	1
4	5060200391X00	Thermal Pad for LTE Module	35x30x1.5mm PK404HC	1
5	5060200500X00	Thermal Pad for Wi-Fi module	18x18x1.5mm K=2.5 W/mk PK404HC	1
6	7400120034X00	Power Adapter	POWER ADAPTER EDAC:EA11011H(T25) 120W 12V/10A W/LOCK 4 PIN DC JACK	1
7	4NCPM00203X00	Terminal Block	2P PHOENIX CONTACT:1803578 ASSY 3.81mm MALE 90D GREEN	1

## Ordering Information

The following below provides ordering information for Neu-X304.

### **Neu-X304-Q (P/N:10W10X30405X0)**

12th/13th Intel® Core™ Edge Computing fanless system w/ Intel® PCH Q670E, 3 x HDMI®, 12-24V DC

### **Neu-X304-H (P/N:10W10X30401X0)**

12th/13th Intel® Core™ Edge Computing fanless system w/ Intel® PCH H610E, 3 x HDMI®, 12V DC only

# CHAPTER 1: PRODUCT INTRODUCTION

## Neu-X304 Series

### Overview



Front Panel



Rear Panel

### Key Features

- 12/13th generation Intel® Core™i9/i7/i5/i3 socket type processor, up to 35W
- 3 x HDMI® 2.0 resolution 4K@60Hz
- Dual DDR5 SO-DIMM
- Dual Intel® LAN
- Multiple expansion slots: 1 x M.2 M Key, 1 x M.2 E Key, 1 x M.2 B Key
- Support Intel® AMT Technology (Q670E support)
- TPM 2.0 IC onboard
- Support 12V/12-24V DC Power Input
- Fanless Design

## Hardware Specifications

### CPU Support

- 12th /13th Gen Intel® Core™ i9/i7/i5/i3 processor, up to 35W
  - Intel® Core™ i9-12900TE, 16 core, 1.1 GHz (P-Core) and 1GHz (E-Core), 30M Cache, 35W
  - Intel® Core™ i7-12700TE, 12 core, 1.4 GHz (P-Core) and 1GHz (E-Core), 25M Cache, 35W
  - Intel® Core™ i5-12500TE, 6 core, 1.9 GHz (P-Core),18M Cache, 35W
  - Intel® Core™ i3-12100TE, 4 core, 2.1 GHz (P-Core),12M Cache, 35W
  - Intel® Core™ i9-13900TE, 16 core, 1.0 GHz (P-Core) and 800MHz (E-Core), 36M Cache, 35W
  - Intel® Core™ i7-13700TE, 16 core, 1.1 GHz (P-Core) and 800GHz (E-Core), 30M Cache, 35W
  - Intel® Core™ i5-13500TE, 14 core, 1.3 GHz (P-Core) and 1.1GHz (E-Core), 24M Cache, 35W
  - Intel® Core™ i3-13100TE, 4 core, 2.4 GHz (P-Core),12M Cache, 35W

### Chipset

- Intel® PCH Q670E
- Intel® PCH H610E

### Graphics

- Intel® UHD Graphics 770

### Main Memory

- 2 x 262-pin SO-DIMM socket, DDR5, 4800MHz, supports up to 64GB

### I/O Interface-Front

- 1 x Power Button
- 1 x HDD LED Indicator
- 2 x COM ports:
  - COM1: RS-232/422/485
  - COM2: RS-232, support RI/12V/5V, select by jumper

- 4 x USB 2.0 Port
- 1 x Remote ON/OFF Switch

### I/O Interface-Rear

- 1 x DC Jack
- 4 x USB 3.2 (Q670E) or 3 x USB 3.2 + 1 x USB 2.0 (H610E)
- 1 x Intel® i219-LM(1GbE), 1x Intel® i226-V (2.5GbE)
- 3 x HDMI® 2.0 output
- 1 x Mic in, 1 x Line out powered by Realtek ALC888S

### Internal I/O

- 1 x GPIO, TTL level, 4 x GPI, 4 x GPO
- 1 x Internal speaker pin header with 2W 4Ω Amplifier
- 2x Reserved COM port ( By request):
  - COM3: RS-232/422/485
  - COM4: RS-232

### Expansion

- 1 x M.2 Key E, 2230, supports Wi-Fi 6/6E+Bluetooth module
- 1 x M.2 Key B, 3042/3052, supports LTE/5G module

### Storage

- 1x M.2 Key M, 2280, supports PCIe x4 and SATA signal

### Power Requirements

- Q670E: 12-24V DC, max up to 120W
- H610E: 12V DC Only, max up to 120W

### Environment

- Operating temperature: -5°C to 45°C (according to IEC 60068-2-1, IEC 60068-2-2, IEC 60068-2-14)
- Relative humidity (non-condensing): 95% (non-condensing)



- Storage temperature: -20°C to 80°C
- Shock protection: 50G peak acceleration, 11 ms according to IEC 60068-2-27
- Vibration protection
  - Random: 2Grms@5~500Hz, IEC 60068-2-64
  - Sinusoidal: 2G@5~500Hz, IEC 60068-2-6

### **Certification**

- CE (EMC EN 55032 + EN 55035)
- FCC Class A

### **Dimension**

- Aluminum and metal chassis with fanless design
- 240mm(L) x 210(W) x 54mm (H) with mounting bracket
- 210mm(L) x 210(W) x 50mm (H) w/o mounting bracket

### **Operating System**

- Win10/Win11/Linux

## Physical Features

### Neu-X304-Q Front Panel

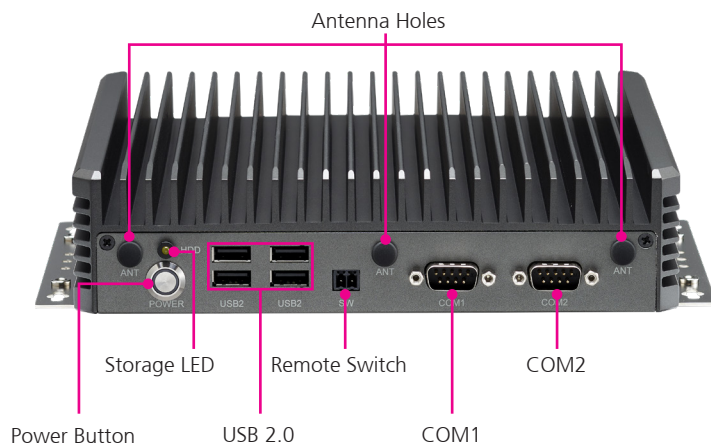

### Neu-X304-Q Rear Panel

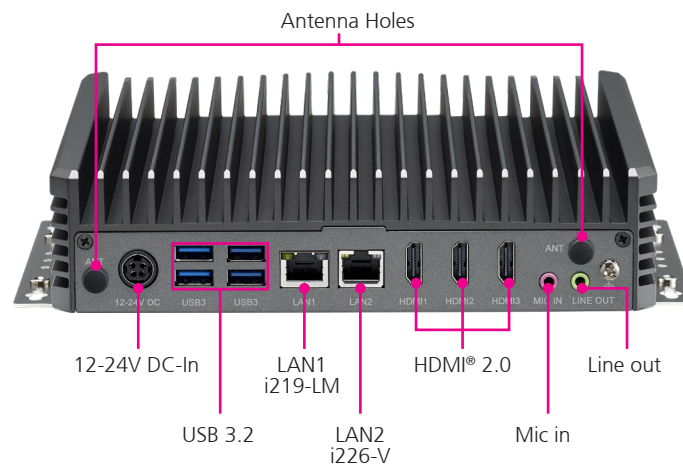

## Physical Features

### Neu-X304-H Front Panel

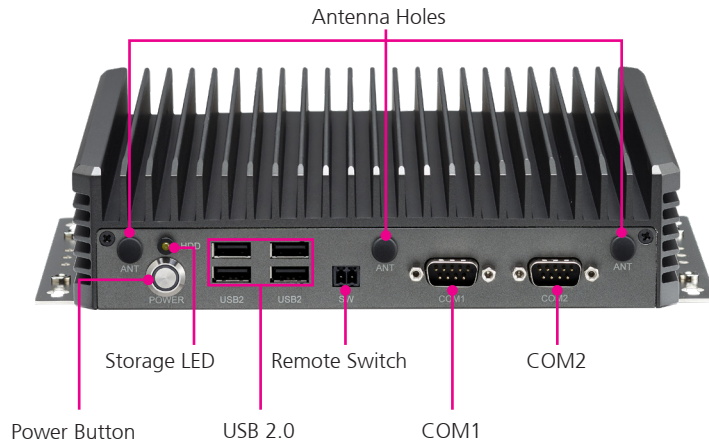

### Neu-X304-H Rear Panel

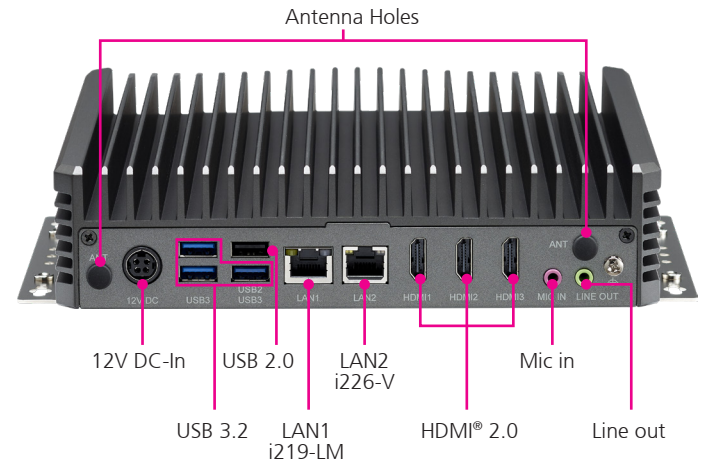

# Mechanical Dimensions

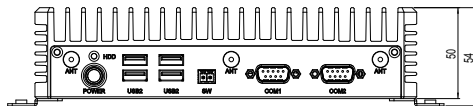
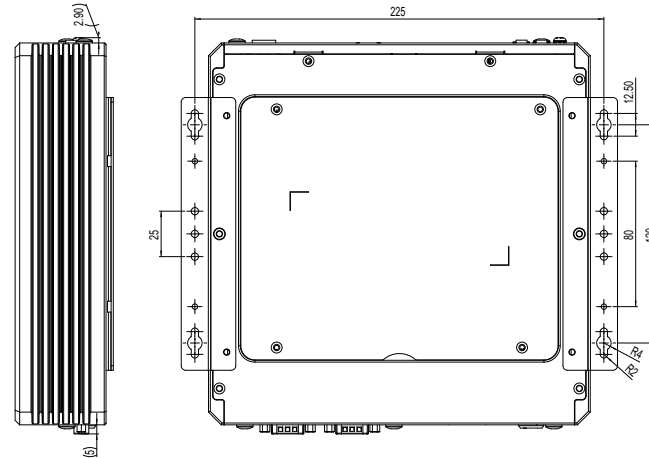
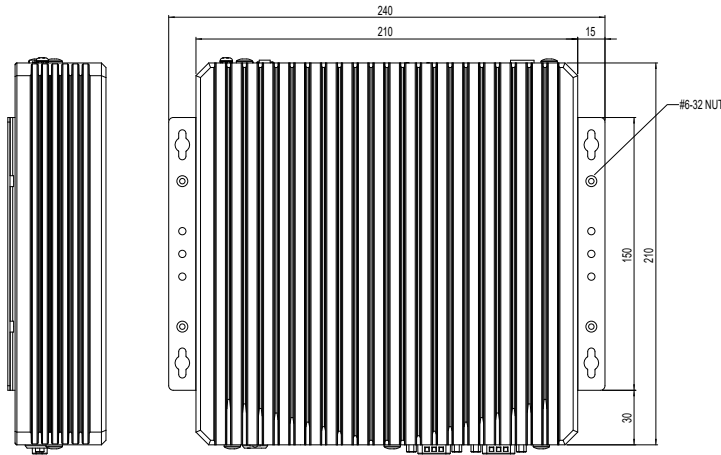
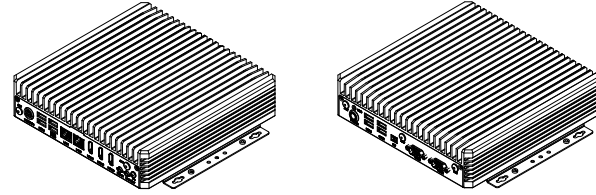
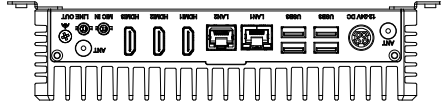

## CHAPTER 2: JUMPERS AND CONNECTORS

This chapter lists the locations of the jumpers and connectors for the Neu-X304 series.

### Before You Begin

- Ensure you have a stable, clean working environment. Dust and dirt can get into components and cause a malfunction. Use containers to keep small components separated.
- Adequate lighting and proper tools can prevent you from accidentally damaging the internal components. Most of the procedures that follow require only a few simple tools, including the following:
  - A Philips screwdriver
  - A flat-tipped screwdriver
  - A set of jewelers screwdrivers
  - A grounding strap
  - An anti-static pad
- Using your fingers can disconnect most of the connections. It is recommended that you do not use needle-nosed pliers to disconnect connections as these can damage the soft metal or plastic parts of the connectors.
- Before working on internal components, make sure that the power is off. Ground yourself before touching any internal components, by touching a metal object. Static electricity can damage many of the electronic components. Humid environments tend to have less static electricity than

dry environments. A grounding strap is warranted whenever danger of static electricity exists.

### Precautions

Computer components and electronic circuit boards can be damaged by discharges of static electricity. Working on computers that are still connected to a power supply can be extremely dangerous.

Follow the guidelines below to avoid damage to your computer or yourself:

- Always disconnect the unit from the power outlet whenever you are working inside the case.
- If possible, wear a grounded wrist strap when you are working inside the computer case. Alternatively, discharge any static electricity by touching the bare metal chassis of the unit case, or the bare metal body of any other grounded appliance.
- Hold electronic circuit boards by the edges only. Do not touch the components on the board unless it is necessary to do so. Don't flex or stress the circuit board.
- Leave all components inside the static-proof packaging that they shipped with until they are ready for installation.
- Use correct screws and do not over tighten screws.

## Jumper Settings

A jumper is the simplest kind of electric switch. It consists of two metal pins and a cap. When setting the jumpers, ensure that the jumper caps are placed on the correct pins. When the jumper cap is placed on both pins, the jumper is short. If you remove the jumper cap, or place the jumper cap on just one pin, the jumper is open.

Refer to the illustrations below for examples of what the 2-pin and 3-pin jumpers look like when they are short (on) and open (off).

Two-Pin Jumpers: Open (Left) and Short (Right)

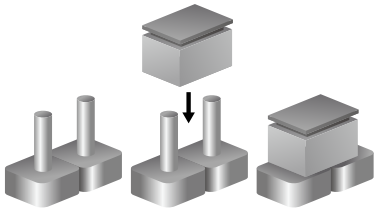

Three-Pin Jumpers: Pins 1 and 2 are Short

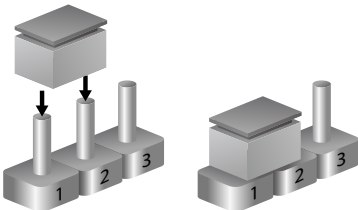

## Locations of the Jumpers and Connectors for the Neu-X304 Series

The following figures show the motherboard of Neu-X304 series, and indicates the locations of jumpers and connectors. Refer to this chapter for detailed pin setting and definitions of connectors marked in pink on this figure.

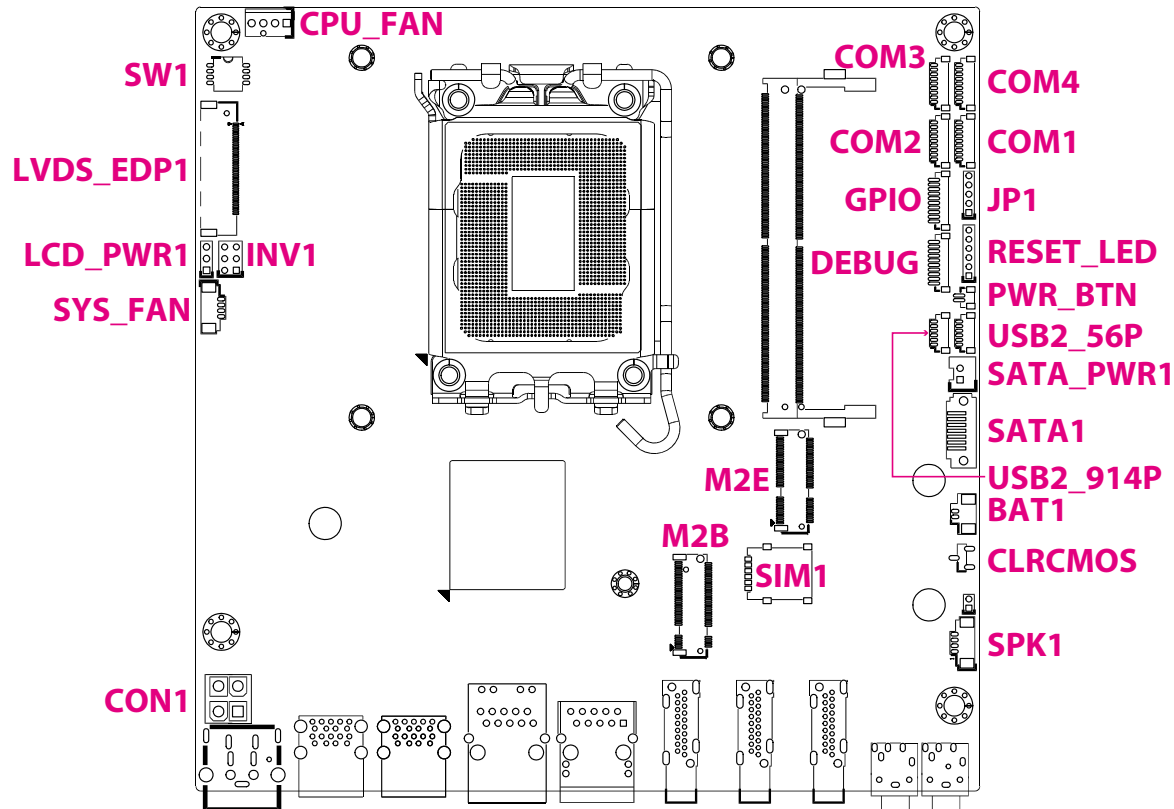

Continued on next page

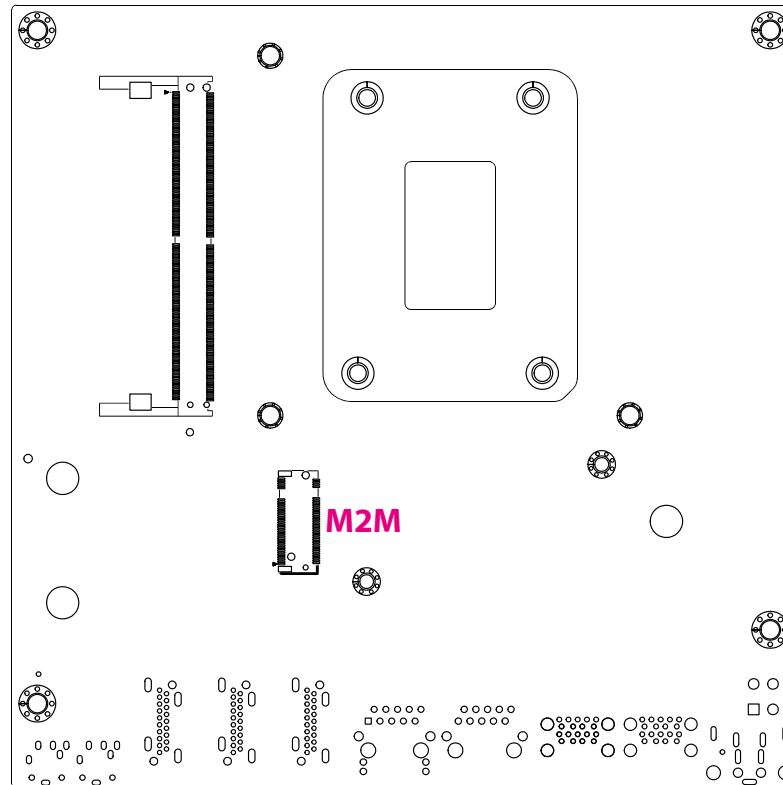



## Jumpers & DIP Switches

### Clear CMOS

Connector type: 1x3 3-pin header, 2.0mm pitch

Connector location: CLRCMOS

1  3

Pin	Settings
1-2 On	Normal (default)
2-3 On	Clear CMOS

### COM2 RI Select

Connector type: 1x5-pin header, 2.0mm pitch

Connector location: JP1

1  5

Pin	Settings
1	RI (Default)
2	COM2_RI (Default)
3	+5V
4	COM2_RI
5	+12V

## LCD Panel Voltage Select

Connector type: 1x3 3-pin header, 2.0mm pitch

Connector location: LCD\_PWR1



SW [3:0]	SW1 [3]	SW1 [2]	SW1 [1]	SW1 [0]	Function
0000	ON	ON	ON	ON	800 x 600 6-bit Single Port
0001	ON	ON	ON	OFF	1024 x 768 6-bit Single Port
0010	ON	ON	OFF	ON	1024 x 768 8-bit Single Port
0011	ON	ON	OFF	OFF	1280 x 1024 6-bit Single Port
0100	ON	OFF	ON	ON	1280 x 800 6-bit Single Port
0101	ON	OFF	ON	OFF	1280 x 960 6-bit Single Port
0110	ON	OFF	OFF	ON	1280 x 1024 8-bit Dual Port
0111	ON	OFF	OFF	OFF	1366 x 768 6-bit Single Port
1000	OFF	ON	ON	ON	1366 x 768 8-bit Single Port
1001	OFF	ON	ON	OFF	1440 x 900 8-bit Dual Port
1010	OFF	ON	OFF	ON	1400 x 1050 8-bit Dual Port
1011	OFF	ON	OFF	OFF	1600 x 900 8-bit Dual Port
1100	OFF	OFF	ON	ON	1680 x 1050 8-bit Dual Port
1101	OFF	OFF	ON	OFF	1600 x 1200 8-bit Dual Port
1110	OFF	OFF	OFF	ON	1920 x 1080 8-bit Dual Port
1111	OFF	OFF	OFF	OFF	1920 x 1200 8-bit Dual Port

## Connector Pin Definitions

### External I/O Interfaces

#### Mic In Jack

Connector type: Phone Jack single port, 6P, pink

Connector location: CN1



Pin	Definition	Pin	Definition
1	MIC_R	2	MIC_JD
3	AGND	4	LOUT_L
5	AGND	6	AGND

#### Line Out Jack

Connector type: Phone Jack single port, 6P, green

Connector location: CN2



Pin	Definition	Pin	Definition
1	LOUT_R	2	LOUT_JD
3	AGND	4	LOUT_L
5	AGND	6	AGND

## HDMI® Port

Connector type: HDMI®

Connector location: HDMI1, HDMI2, and HDMI3

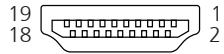

Pin	Definition	Pin	Definition
1	HDMI_TX2P	2	GND
3	HDMI_TX2N	4	HDMI_TX1P
5	GND	6	HDMI_TX1N
7	HDMI_TX0P	8	GND
9	HDMI_TX0N	10	HDMI_CLK_P
11	GND	12	HDMI_CLK_N
13	NC	14	NC
15	HDMI_SCL	16	HDMI_SDA
17	GND	18	HDMI_P5V
19	HDMI_HPD		

## LAN Port (i219-LM)

Connector type: RJ45 LAN Port W/LED

Connector location: LAN1

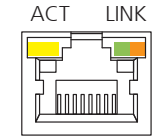

Pin	Definition	Pin	Definition
1	LAN1_MDI0P	2	LAN1_MDI0N
3	LAN1_MDI1P	4	LAN1_MDI1N
5	TCT	6	TCTG
7	LAN1_MDI2P	8	LAN1_MDI2N
9	LAN1_MDI3P	10	LAN1_MDI3N
11	LAN1LED1G#	12	LAN1LED100#
13	LAN1LEDACTN	14	LAN1ACTPW
MH1	CGND	MH2	CGND

### LED Indicators

Act	Status	Link	Status
Flashing Yellow	Data activity	Steady Green	1G network link
Off	No activity	Steady Orange	100Mbps network link
		Off	No activity

## LAN Port (i226-V)

Connector type: RJ45 LAN Port W/LED

Connector location: LAN2

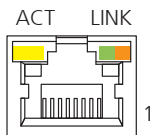

Pin	Definition	Pin	Definition
1	LAN1_MDIOP	2	LAN1_MDI0N
3	LAN1_MDI1P	4	LAN1_MDI1N
5	TCT	6	TCTG
7	LAN1_MDI2P	8	LAN1_MDI2N
9	LAN1_MDI3P	10	LAN1_MDI3N
11	LAN1LED1G#	12	LAN1LED100#
13	LAN1LEDACTN	14	LAN1ACTPW
MH1	CGND	MH2	CGND

### LED Indicators

Act	Status	Link	Status
Flashing Yellow	Data activity	Steady Green	1G/2.5G network link
Off	No activity	Steady Orange	100Mbps network link or 10Mbps no activity
		Off	10Mbps or no link

## USB Ports (Neu-X304-Q)

Connector type: USB 3.2 ports (Stacked Type)

Connector location: USB3\_12P and USB3\_45P

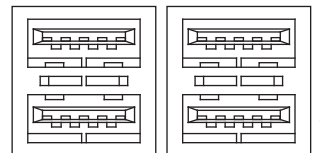

Pin	Definition	Pin	Definition
1	+5V	2	USB2_3N
3	USB2_3P	4	GND
5	USB3_RX3N	6	USB3_RX3P
7	GND	8	USB3_TX3N
9	USB3_TX3P	10	+5V
11	USB2_4N	12	USB2_4P
13	GND	14	USB3_RX4N
15	USB3_RX4P	16	GND
17	USB3_TX4N	18	USB3_TX4P
MH1	CGND	MH2	CGND
MH3	CGND	MH4	CGND

## USB Ports (Neu-X304-H)

Connector type: 3 x USB 3.2 and 1 x USB 2.0 ports (Stacked Type)

Connector location: USB3\_12P and USB3\_45P

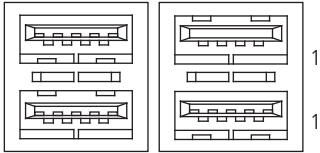

## DC-In Power

Connector type: +12V~24V

Connector location: DCIN1

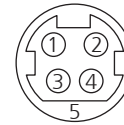

### USB 3.2

Pin	Definition	Pin	Definition
1	+5V	2	USB2_3N
3	USB2_3P	4	GND
5	USB3_RX3N	6	USB3_RX3P
7	GND	8	USB3_TX3N
9	USB3_TX3P	10	+5V
11	USB2_4N	12	USB2_4P
13	GND	14	USB3_RX4N
15	USB3_RX4P	16	GND
17	USB3_TX4N	18	USB3_TX4P
MH1	CGND	MH2	CGND
MH3	CGND	MH4	CGND

Pin	Definition	Pin	Definition
1	+12VSUS	2	+12VSUS
3	GND	4	GND
5	CGND		

### USB2.0

Pin	Definition	Pin	Definition
1	+5V	2	USB2_N
3	USB2_P	4	GND

## Internal I/O Interfaces

### Battery Connector

Connector type: WtoB, 1x2-pin header, 1.25mm

Connector location: BAT1

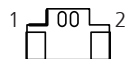

Pin	Definition
1	GND
2	BAT

### COM Ports

Connector type: WtoB, 1x9-pin header, 1.0mm pitch

Connector location: COM1, COM2 COM3, and COM4

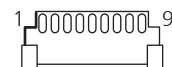

Pin	Definition	Pin	Definition
1	RI#	2	CTS#
3	RTS#	4	DSR#
5	GND	6	DTR#
7	TXD	8	RXD
9	DCD#		

## ATX +12V Power Connector

Connector type: ATX Power Connector, 2x2 Male

Connector location: CON1

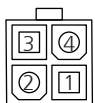

Pin	Definition	Pin	Definition
1	GND	2	GND
3	+12VSUS	4	+12VSUS

## FAN Connector

Connector type: WtoB, 1x4-pin header, 2.54mm pitch

Connector location: CPU\_FAN

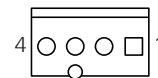

Pin	Definition	Pin	Definition
1	GND	2	+12V
3	CPU FAN SPEED DETECT	4	CPU FAN SPEED CONTROL



## Debug Port/LPC Bus Connector

Connector type: WtoB, 1x10-pin header, 1.0mm pitch

Connector location: DEBUG

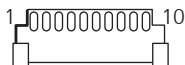

Pin	Definition	Pin	Definition
1	GND	2	PLTRST#
3	ESPI_CLK	4	ESPI_CS#
5	ESPI_IO3	6	ESPI_IO2
7	ESPI_IO1	8	ESPI_IO0
9	ESPI_RST#	10	3.3V

## GPIO Connectors

Connector type: WtoB, 1x10-pin header, 1.0mm pitch

Connector location: GPIO

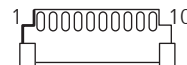

Pin	Definition	Pin	Definition
1	+5V	2	GND
3	GPO0	4	GPO1
5	GPO2	6	GPO3
7	GPIO	8	GPI1
9	GPI2	10	GPI3

## LVDS Inverter Connector

Connector type: 2x3, 6-pin header JST, 2.54mm pitch

Connector location: INVN1

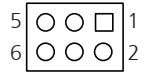

Pin	Definition	Pin	Definition
1	GND	2	GND
3	+V_INV	4	+V_INV
5	INV_BKLTEN	6	INV_BKLTCTRL

## LVDS/eDP Panel Connector

Connector type: 1x40-pin connector, 0.5mm pitch

Connector location: LVDS\_EDP1



### LVDS

Pin	Definition	Pin	Definition
1	LVDS_DAT3P	2	LVDS_DAT6P
3	LVDS_DAT3N	4	LVDS_DAT6N
5	LVDS_DAT2P	6	LVDS_DAT5P
7	LVDS_DAT2N	8	LVDS_DAT5N
9	LVDS_DAT1P	10	LVDS_DAT4P
11	LVDS_DAT1N	12	LVDS_DAT4N
13	LVDS_DAT0P	14	GND
15	LVDS_DAT0N	16	+V_PANEL
17	LVDS_DAT7P	18	+V_PANEL
19	LVDS_DAT7N	20	+V_PANEL

Pin	Definition	Pin	Definition
21	GND	22	Hot-Plug Detect
23	+V_PANEL	24	INV_BKLTEN
25	GND	26	INV_BKLTCTRL
27	GND	28	LVDS_CLK2P
29	GND	30	LVDS_CLK2N
31	LVDS_CLK1P	32	+V_INV
33	LVDS_CLK1N	34	+V_INV
35	GND	36	+V_INV
37	GND	38	+V_INV
39	GND	40	N.C.

Continued on next page

## eDP

Pin	Definition	Pin	Definition
1	N.C.	2	N.C.
3	N.C.	4	N.C.
5	EDP_TX0P	6	N.C.
7	EDP_TX0N	8	N.C.
9	EDP_TX1P	10	N.C.
11	EDP_TX1N	12	N.C.
13	EDP_HPD	14	GND
15	N.C.	16	+V_PANEL
17	N.C.	18	+V_PANEL
19	N.C.	20	+V_PANEL

Pin	Definition	Pin	Definition
21	GND	22	Hot-Plug Detect
23	+V_PANEL	24	INV_BKLTEN
25	GND	26	INV_BKLTCTRL
27	GND	28	N.C.
29	GND	30	N.C.
31	EDP_AUXP	32	+V_INV
33	EDP_AUXN	34	+V_INV
35	GND	36	+V_INV
37	GND	38	+V_INV
39	GND	40	GND

## M.2 Key B 3042/3052 Connector

Connector location: M2B

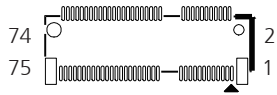

Pin	Definition	Pin	Definition
1	CONFIG3	2	3.3V
3	GND	4	3.3V
5	GND	6	POWER_OFF#
7	USB2_5P	8	WIFI_DIS#
9	USB2_5N	10	LED#
11	NC		
		20	Telit FN980 PCIe/USB Select Pin
21	CONFIG0	22	NC

Pin	Definition	Pin	Definition
23	NC	24	NC
25	NC	26	WWAN_GPS_ON
27	GND	28	NC
29	USB3_RXN	30	UIM_RESET
31	USB3_RXP	32	UIM_CLK
33	GND	34	UIM_DATA
35	USB3_TXN	36	UIM_PWR
37	USB3_TXP	38	NC
39	GND	40	NC

Continued on next page

Pin	Definition	Pin	Definition
41	PCIE_RXN	42	NC
43	PCIE_RXP	44	NC
45	GND	46	NC
47	PCIE_TXN	48	NC
49	PCIE_TXP	50	RESET(3.3V)
51	GND	52	CLKREQ#
53	CLK_DN	54	WAKE#
55	CLK_DP	56	NC
57	GND	58	NC

Pin	Definition	Pin	Definition
59	NC	60	NC
61	NC	62	NC
63	NC	64	NC
65	NC	66	NC
67	RESET(1.8V)	68	SUS_CLK
69	CONFIG1	70	3.3V
71	GND	72	3.3V
73	GND	74	3.3V
75	CONFIG2		

## M.2 Key E 2230 Connector

Connector location: M2E

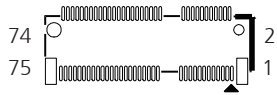

Pin	Definition	Pin	Definition
1	GND	2	3.3V_1
3	USB_D+	4	3.3V_2
5	USB_D-	6	LED1#
7	GND2	8	PCM_CLK
9	SDIO_CLK	10	PCM_SYNC
11	SDIO_CMD	12	PCM_IN
13	SDIO_DATA0	14	PCM_OUT
15	SDIO_DATA1	16	LED2#
17	SDIO_DATA2	18	GND3

Pin	Definition	Pin	Definition
19	SDIO_DATA3	20	UART_WAKE#
21	SDIO_WAKE#	22	UART_RXD
23	SDIO_RESET#		
		32	UART_TXD
33	GND4	34	UART_CTS
35	PETP0	36	UART_RTS
37	PETN0	38	RESERVED_1
39	GND5	40	RESERVED_2

Continued on next page

Pin	Definition	Pin	Definition
41	PERP0	42	RESERVED_3
43	PERN0	44	COEX3
45	GND6	46	COEX2
47	REFCLKP0	48	COEX1
49	REFCLKN0	50	SUSCLK
51	GND7	52	PERST0#
53	CLKREQ0#	54	W_DISABLE2#
55	PEWAKE0#	56	W_DISABLE1#
57	GND8	58	I2C_DATA

Pin	Definition	Pin	Definition
59	PETP1	60	I2C_CLK
61	PETN1	62	ALERT#
63	GND9	64	RESERVED
65	PERP1	66	UIM_SWP
67	PERN1	68	UIM_POWER_SNK
69	GND10	70	UIM_POWER_SRC
71	PEFCLKP1	72	3.3V_3
73	PEFCLKN1	74	3.3V_4
75	GND11		



## M.2 Key M 2280 Connector

Connector location: M2M (Support PCIe x4, SATA)

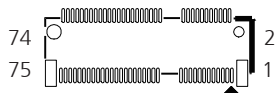

Pin	Definition	Pin	Definition
1	GND	2	VCC3
3	GND	4	VCC3
5	PCIE3_RXN	6	NC
7	PCIE3_RXP	8	NC
9	GND	10	M2M_LED#
11	PCIE3_TXN	12	VCC3
13	PCIE3_TXP	14	VCC3
15	GND	16	VCC3
17	PCIE2_RXN	18	VCC3

Pin	Definition	Pin	Definition
19	PCIE2_RXP	20	NC
21	GND	22	NC
23	PCIE2_TXN	24	NC
25	PCIE2_TXP	26	NC
27	GND	28	NC
29	PCIE1_RXN	30	NC
31	PCIE1_RXP	32	NC
33	GND	34	NC
35	PCIE1_TXN	36	NC

Continued on next page

Pin	Definition	Pin	Definition
37	PCIE1_TXP	38	DEVSLP
39	GND	40	NC
41	SATA_RXP(PCIE0_RXP)	42	DEVSLP
43	SATA_RXN(PCIE0_RXN)	44	NC
45	GND	46	NC
47	SATA_TXN(PCIE0_TXN)	48	NC
49	SATA_TXP(PCIE0_TXP)	50	NC
51	GND	52	NC
53	CLK_PCIE1	54	RESET#

Pin	Definition	Pin	Definition
55	CLK_PCIEP	56	CLKREQ#
57	GND	58	WAKE#
67	NC	68	NC
69	M2M_PEDET	70	VCC3
71	GND	72	VCC3
73	GND	74	VCC3
75	GND		

## System Power Button Connector

Connector type: WtoB, 1x2-pin header, 1.0mm pitch

Connector location: PWR\_BTN

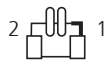

Pin	Definition
1	GND
2	PWRBTN#

## System Reset Button, HDD LED, and Power LED

Connector type: 1x6-pin header, 2.0mm pitch

Connector location: RESET\_LED



Pin	Definition
1	GND
2	RESET#
3	HDD_LED+
4	HDD_LED-
5	PWR_LED+
6	PWR_LED-

## SATA Connector

Connector type: Standard Serial ATA 7P (1.27mm, SATA-M-180)

Connector location: SATA1



Pin	Definition
1	GND
2	SATA_TXP
3	SATA_TXN
4	GND
5	SATA_RXN
6	SATA_RXP
7	GND

## System Power Button Connector

Connector type: 1x2 2-pin header, 2.5mm pitch

Connector location: SATA\_PWR1

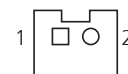

Pin	Definition
1	+5V
2	GND

## Speaker Connector

Connector type: WtoB, 1x4-pin header, 1.25mm

Connector location: SPK

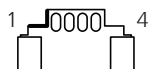

Pin	Definition
1	L_OUT+
2	L_OUT-
3	R_OUT+
4	R_OUT-

## FAN Connector

Connector type: WtoB, 1x4-pin header, 1.25mm pitch

Connector location: SYS\_FAN

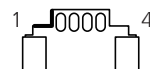

Pin	Definition	Pin	Definition
1	GND	2	+12V
3	SYS FAN SPEED DETECT	4	SYS FAN SPEED CONTROL

## Internal USB 2.0 Connector

Connector type: WtoB, 1x6-pin header, 1.0mm pitch

Connector location: USB2\_56P, USB2\_914P



Pin	Definition
1	GND
2	USB2N
3	USB2P
4	USB1N
5	USB1P
6	+5V

## CHAPTER 3: SYSTEM SETUP

### Removing the Bottom Cover from the Chassis



Prior to installing a 2.5" SATA storage drive, make sure the unit's power is off and disconnected from the power sources to prevent electric shock or system damage.

The screws on the front, rear, and bottom are used to secure the cover to the chassis. Remove these screws and put them in a safe place for later use.



## Installing an M.2 SSD Module (M-Key 2280)

1. Loosen the screws from the bottom cover and then remove the cover.
2. Remove the screw from the standoff and put it in a safe place for later use.

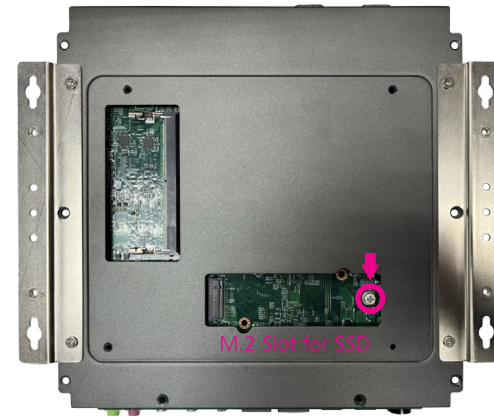



3. Insert the M.2 SSD module into the M.2 slot at a 45-degree angle until the gold-plated connector on the edge of the module completely disappears. With the module fully inserted, tighten the screw removed earlier into the mounting hole on the module to secure it.



## Installing a SO-DIMM Memory Module

1. The system has two SO-DIMM sockets, with one located on the top side and the other on the bottom side of the motherboard. With the top cover removed, install a memory module in the SO-DIMM socket. Insert the module into the socket at an approximately 30-degree angle. Push the module down until the clips on both sides of the socket lock into position. The gold-plated connector on the edge of the module will almost completely disappear inside the socket.
2. For 2<sup>nd</sup> Memory module installation, remove the bottom cover and then insert the module into the socket at an approximately 30-degree angle. Push the module down until the clips on both sides of the socket lock into position.

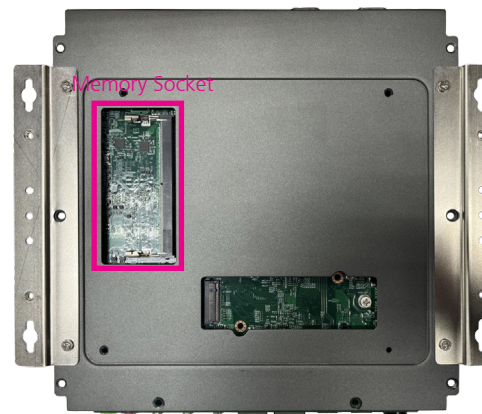
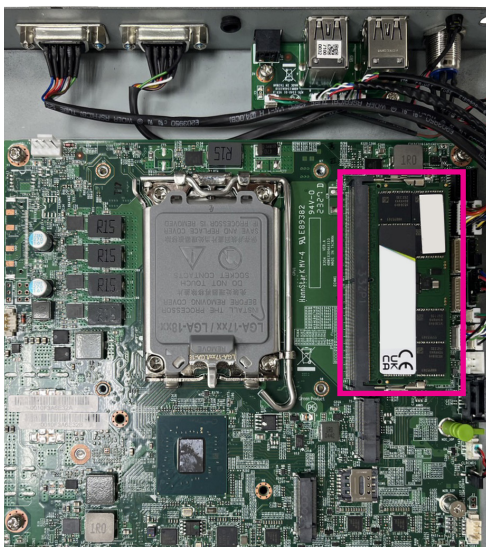

## Installing a Wi-Fi Module (M.2 Key E)

1. With the top cover removed, insert the Wi-Fi module into the slot at a 45-degree angle until the gold-plated connector on the edge of the module completely disappears inside the slot. Push the module down and tighten a screw into the mounting hole on the module to secure it.
2. Attach the RF cable onto the Wi-Fi module and remove the antenna hole cover on the rear panel. Then insert the antenna jack end of the cable through the antenna hole.

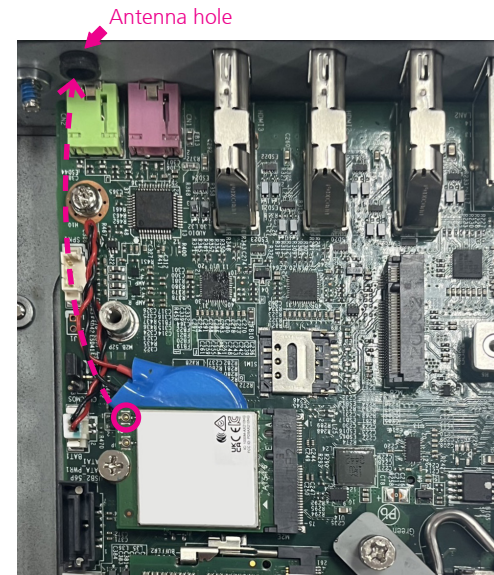
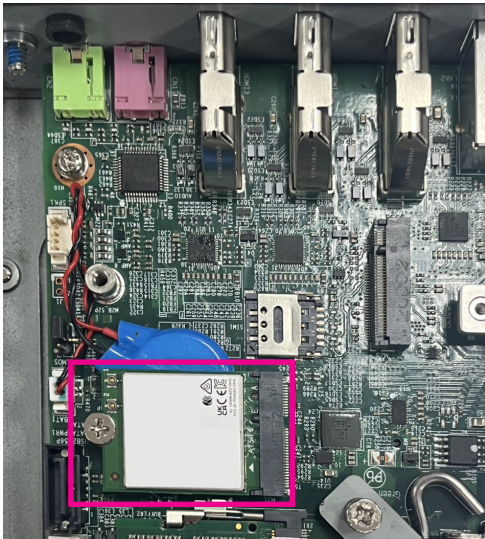

3. Insert the 2 rings (ring 1 then ring 2) into the Wi-Fi antenna jacks.  
Connect the external antenna to the Wi-Fi antenna jack.

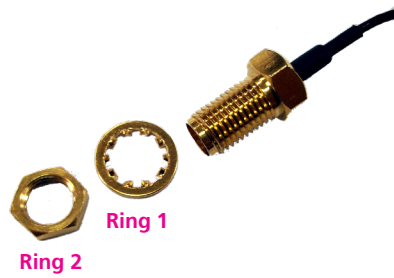

## Installing a 5G/LTE Module (M.2 Key B)

1. With the top cover removed, insert the 5G or LTE module into the slot at a 45-degree angle until the gold-plated connector on the edge of the module completely disappears inside the slot. Push the module down and tighten a screw into the mounting hole on the module to secure it.
2. Attach the RF cable onto the Wi-Fi module and remove the antenna hole cover on the rear panel. Then insert the antenna jack end of the cable through the antenna hole.

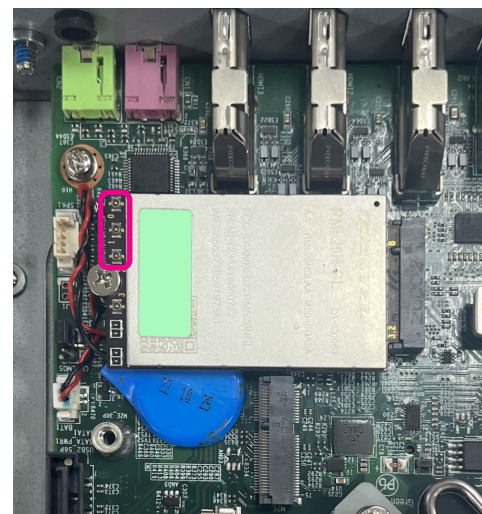
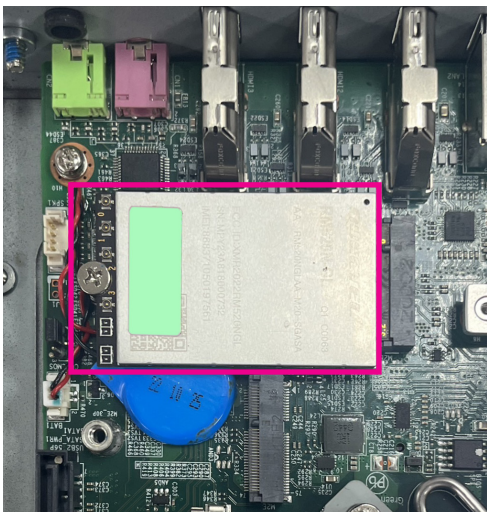

3. Insert the rings (ring 1 then ring 2) into the 5G or LTE antenna jacks.  
Connect the external antenna to the 5G or LTE antenna jack.

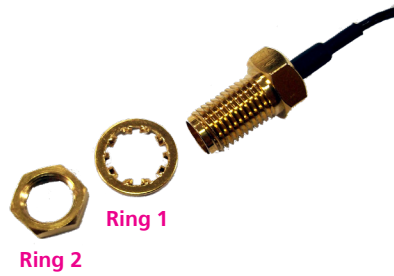

## Installing a CPU

1. Loosen the four mounting screws on the heatsink to access the CPU socket.
2. Unlock the socket by pushing the load lever down, moving it sideways until it is released from the retention tab; then lift the load lever up.

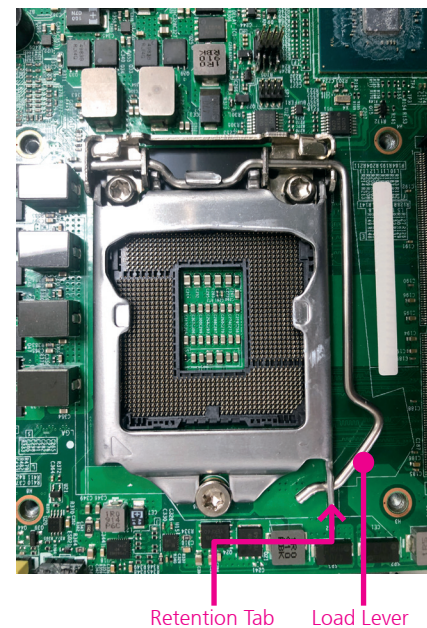
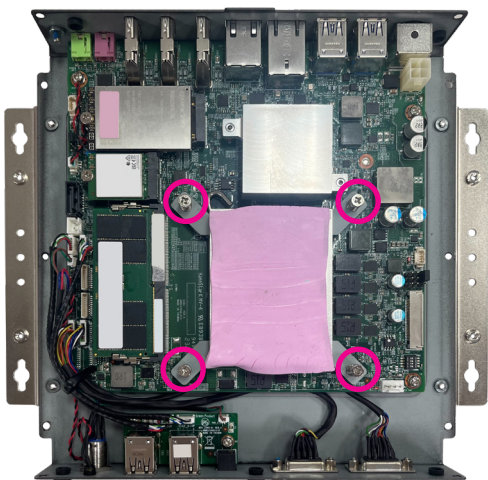

3. Insert the CPU into the socket. The triangular edge on the CPU must align with the corner of the CPU socket shown on the photo.

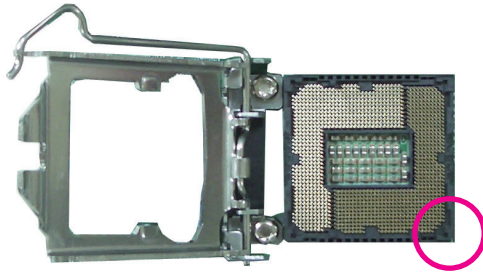

The CPU's notch will at the same time fit into the socket's alignment key.

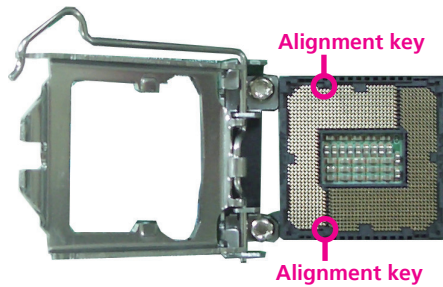

4. Close the load plate and then hook the load lever under the retention tab.



- Handle the CPU by its edges and avoid touching the pins.
- The CPU will fit in only one orientation and can easily be inserted without exerting any force.



Do not force the CPU into the socket. Forcing the CPU into the socket may bend the pins and damage the CPU.



5. Use the thermal grease to dispense on CPU surface such as below.



6. Reinstall the heat sink with the four mounting screws removed earlier.

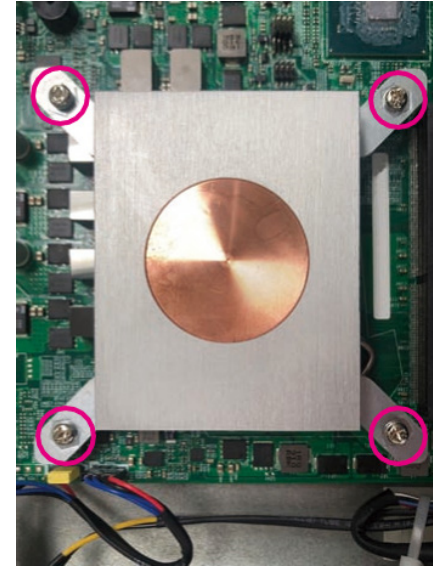

## Wall Mounting Instructions

To mount the system on to a wall or some other surface using the two mounting brackets, please follow the steps below.

1. Turn the system over. Align the two retention screw holes in each bracket with the retention screw holes on the sides of the bottom surface.
2. Secure the brackets to the system by inserting two retention screws into each bracket.
3. Drill holes in the intended installation surface.
4. Align the mounting holes on the sides of the mounting brackets with the predrilled holes on the mounting surface.
5. Insert four retention screws, two in each bracket, to secure the system to the wall.

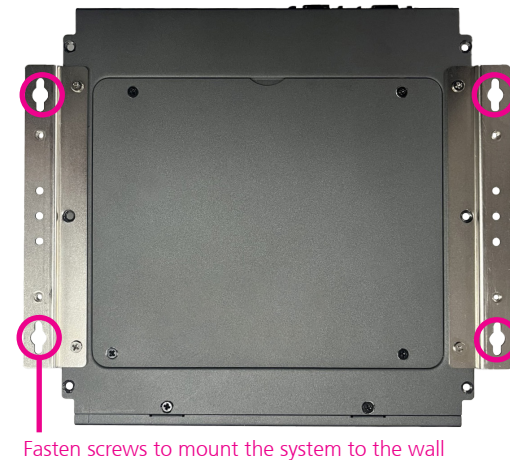
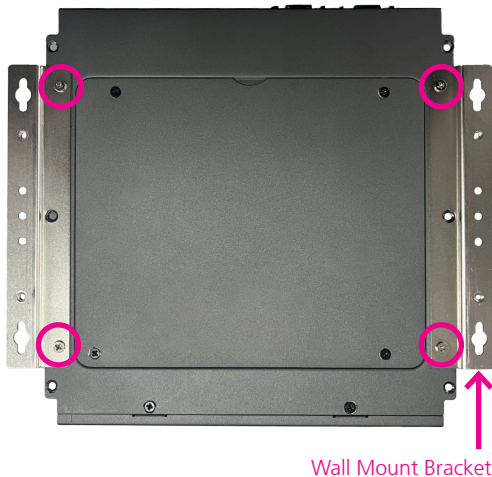

Specification of the wall mount screw: Round Head Screw Long  
Fei: P6#32TX8L\_w/Spring+Flat Washer

# CHAPTER 4: BIOS SETUP

This chapter describes how to use the BIOS setup program for the Neu-X304 series. The BIOS screens provided in this chapter are for reference only and may change if the BIOS is updated in the future.

To check for the latest updates and revisions, visit the NEXCOM website at [www.nexcom.com.tw](http://www.nexcom.com.tw).

## About BIOS Setup

The BIOS (Basic Input and Output System) Setup program is a menu driven utility that enables you to make changes to the system configuration and tailor your system to suit your individual work needs. It is a ROM-based configuration utility that displays the system's configuration status and provides you with a tool to set system parameters.

These parameters are stored in non-volatile battery-backed-up CMOS RAM that saves this information even when the power is turned off. When the system is turned back on, the system is configured with the values found in CMOS.

With easy-to-use pull down menus, you can configure items such as:

- Hard drives, diskette drives, and peripherals
- Video display type and display options
- Password protection from unauthorized use
- Power management features

The settings made in the setup program affect how the computer performs. It is important, therefore, first to try to understand all the setup options, and second, to make settings appropriate for the way you use the computer.

## When to Configure the BIOS

- This program should be executed under the following conditions:
  - When changing the system configuration
  - When a configuration error is detected by the system and you are prompted to make changes to the setup program
  - When resetting the system clock
  - When redefining the communication ports to prevent any conflicts
  - When making changes to the Power Management configuration
  - When changing the password or making other changes to the security setup

Normally, CMOS setup is needed when the system hardware is not consistent with the information contained in the CMOS RAM, whenever the CMOS RAM has lost power, or the system features need to be changed.

## Default Configuration

Most of the configuration settings are either predefined according to the Load Optimal Defaults settings which are stored in the BIOS or are automatically detected and configured without requiring any actions. There are a few settings that you may need to change depending on your system configuration.

## Entering Setup











When the system is powered on, the BIOS will enter the Power-On Self Test (POST) routines. These routines perform various diagnostic checks; if an error is encountered, the error will be reported in one of two different ways:

- If the error occurs before the display device is initialized, a series of beeps will be transmitted.
- If the error occurs after the display device is initialized, the screen will display the error message.

Powering on the computer and immediately pressing <Del> allows you to enter Setup.

Press the  key to enter Setup:

## Legends

Key	Function
	Moves the highlight left or right to select a menu.
	Moves the highlight up or down between sub-menus or fields.
	Exits the BIOS Setup Utility.
	Scrolls forward through the values or options of the highlighted field.
	Scrolls backward through the values or options of the highlighted field.
	Selects a field.
	Displays General Help.
	Load previous values.
	Load optimized default values.
	Saves and exits the Setup program.
	Press <Enter> to enter the highlighted sub-menu

## Scroll Bar

When a scroll bar appears to the right of the setup screen, it indicates that there are more available fields not shown on the screen. Use the up and down arrow keys to scroll through all the available fields.

## Submenu

When “▶” appears on the left of a particular field, it indicates that a submenu which contains additional options are available for that field. To display the submenu, move the highlight to that field and press  .

## BIOS Setup Utility

Once you enter the AMI BIOS Setup Utility, the Main Menu will appear on the screen. The main menu allows you to select from several setup functions and one exit. Use arrow keys to select among the items and press  to accept or enter the submenu.

### Main

The Main menu is the first screen that you will see when you enter the BIOS Setup Utility.

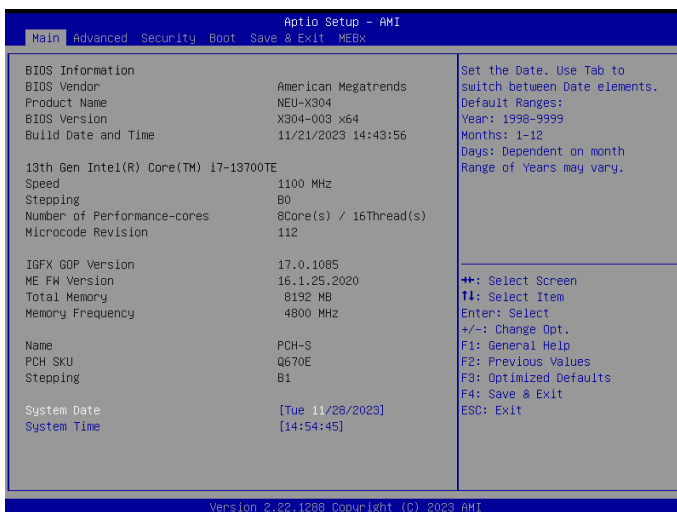

### System Date

The date format is <day>, <month>, <date>, <year>. Day displays a day, from Monday to Sunday. Month displays the month, from January to December. Date displays the date, from 1 to 31. Year displays the year, from 2005 to 2099.

### System Time

The time format is <hour>, <minute>, <second>. The time is based on the 24-hour military-time clock. For example, 1 p.m. is 13:00:00. Hour displays hours from 00 to 23. Minute displays minutes from 00 to 59. Second displays seconds from 00 to 59.

## Advanced

The Advanced menu allows you to configure your system for basic operation. Some entries are defaults required by the system board, while others, if enabled, will improve the performance of your system or let you set some features according to your preference.



Setting incorrect field values may cause the system to malfunction.

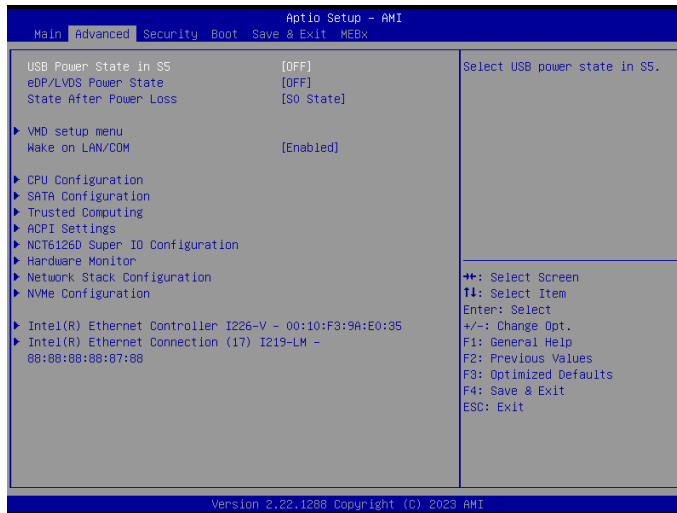

### USB Power State in S5

Select USB power state in S5.

### eDP/LVDS Power State

Select eDP/LVDS controller power state.

### State After Power Loss

Specify what state to go to when power is re-applied after a power failure (G3 State).

### Wake on LAN/COM

Enable or disable integrated LAN/COM port RI to wake the system.

## VMD setup menu



### Enable VMD controller

Enable or disable to VMD controller. Once enabled, more options will be available for configuration.

### Enable RAID0/RAID1/ZPODD

Enable or disable the feature of RAID0/RAID1/ZPODD.

## CPU Configuration

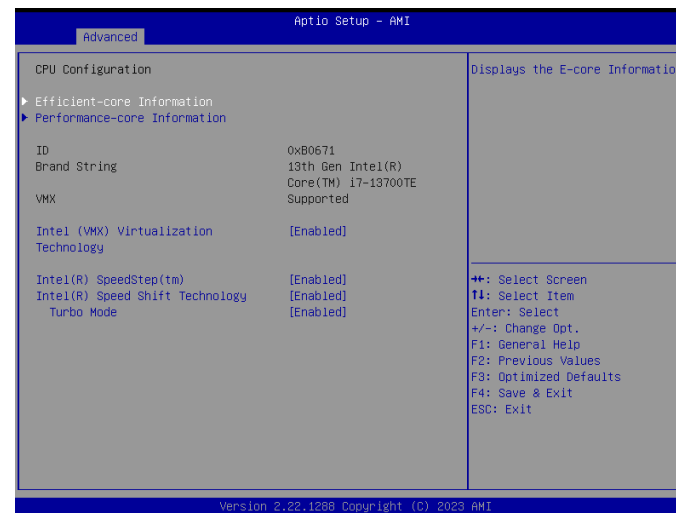

### Efficient-core Information

Press to display the E-core information.

### Performance-core Information

Press to display the P-core information.

### Intel (VMX) Virtualization Technology

When this field is set to Enabled, the VMM can utilize the additional hardware capabilities provided by Vanderpool Technology.

### Inte(R) SpeedStep(tm)

Allow more than two frequency ranges to be supported.



### Intel(R) Speed Shift Technology

Enable or disable Intel Speed Shift Technology support. Enabling it will expose the CPPC v2 interface to allow hardware controlled P-states.

### Turbo Mode

Enable or disable processor turbo mode (requires EMTTM enabled too). Auto means enabled.

### SATA Configuration



### SATA Test Mode

Enable or disable test mode (loop back).

## Trusted Computing

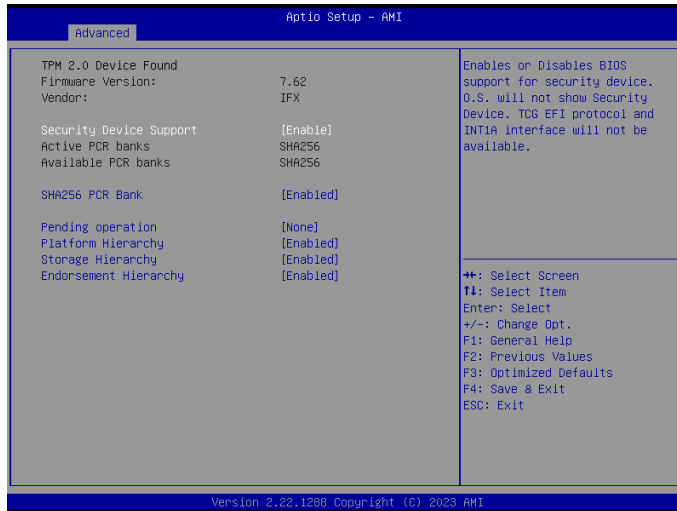

### Platform Hierarchy

Enable or disable platform hierarchy.

### Storage Hierarchy

Enable or disable storage hierarchy.

### Endorsement Hierarchy

Enables or disables endorsement hierarchy

### Security Device Support

Enable or disable BIOS support for security device. O.S will not show Security Device. TCG EFI protocol and INT1A interface will not be available.

### SHA256 PCR Bank

Enable or disable SHA256 PCR Bank.

### Pending operation

Schedule an operation for the security device. **Note:** Your computer will reboot during restart in order to change state of security device.

## ACPI Settings



### Enable Hibernation

Enables or disables system ability to hibernate (OS/S4 Sleep State). This option may not be effective with some OS.

### ACPI Sleep State

Select the highest ACPI sleep state the system will enter when the suspend button is pressed.

## NCT6126D Super IO Configuration

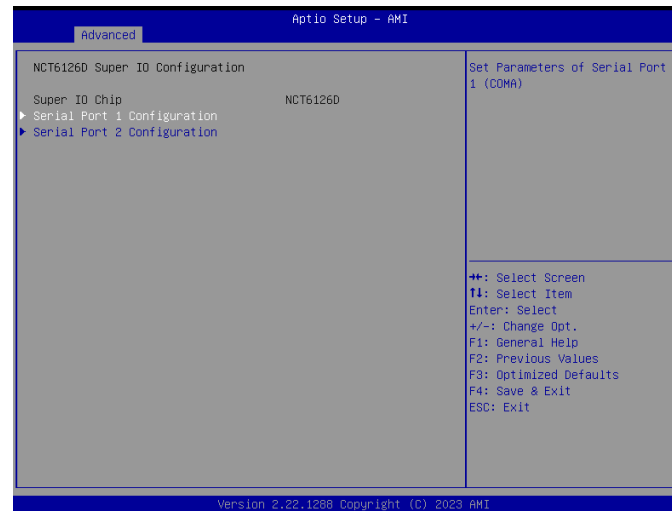

### Serial Port 1 Configuration

Press <Enter> to set parameters of serial port 1 (COMA).

### Serial Port 2 Configuration

Press <Enter> to set parameters of serial port 2 (COMB).

### Serial Port 1 Configuration



#### Serial Port

Enables or disables serial port (COM)

#### Onboard Serial Port 1 Mode

Select a mode for serial port 1. When select RS422/485 mode, the feature of terminal resistor will be available for configuration.

#### Terminal Resistor

Enable or disable built-in termination resistor and bias resistor. TX enable low active.

### Serial Port 2 Configuration

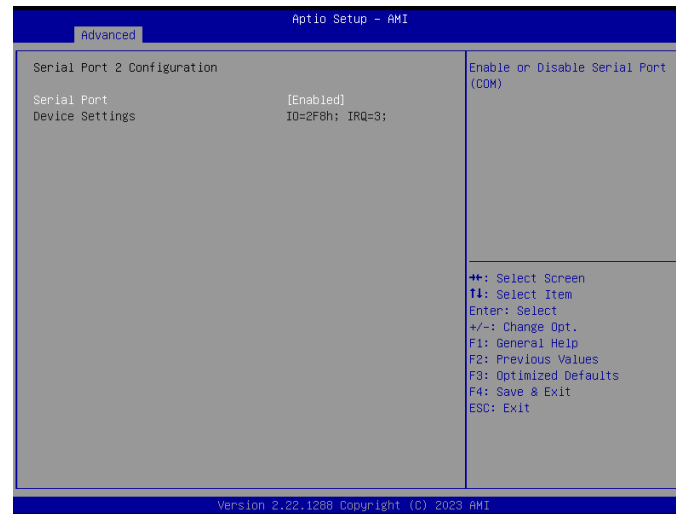

#### Serial Port

Enables or disables serial port (COM)

## Hardware Monitor

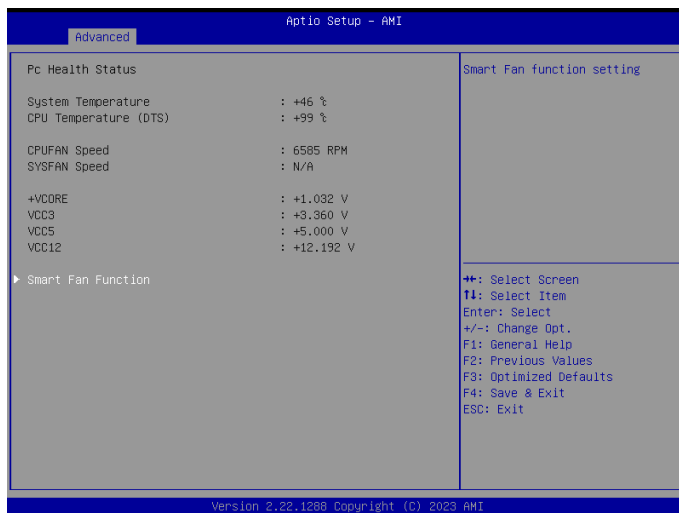

### Smart Fan Function

Enter the Smart Fan Function submenu.

## Smart Fan Function

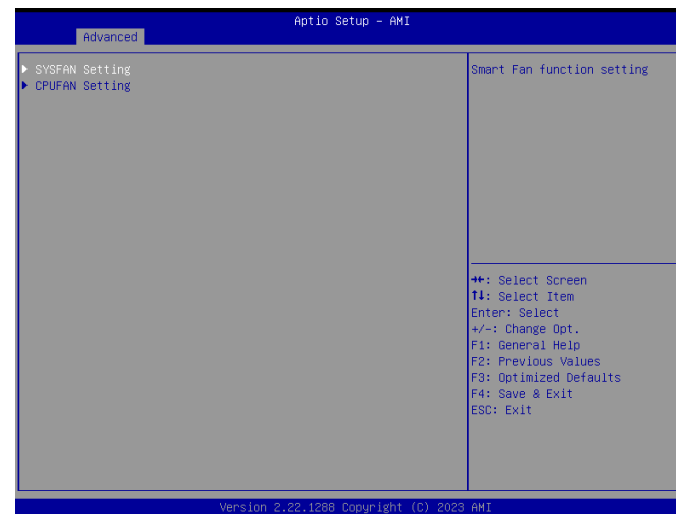

### SYSFAN Setting

Enter the SYSFAN Setting submenu.

### CPUFAN Setting

Enter the CPUFAN Setting submenu.

### Smart Fan Function > SYSFAN Setting

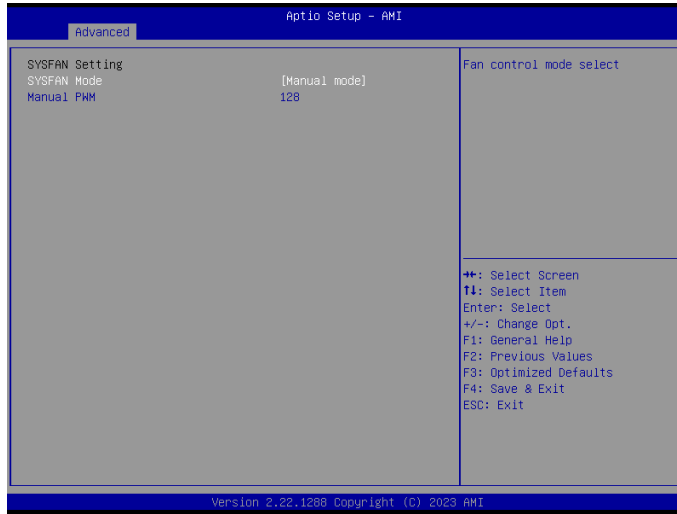

#### SYSFAN Mode

Fan control mode select.

#### Manual PWM

Fan will work with this manual PWM value (0~255 for 0%~100%).

### Smart Fan Function > CPUFAN Setting

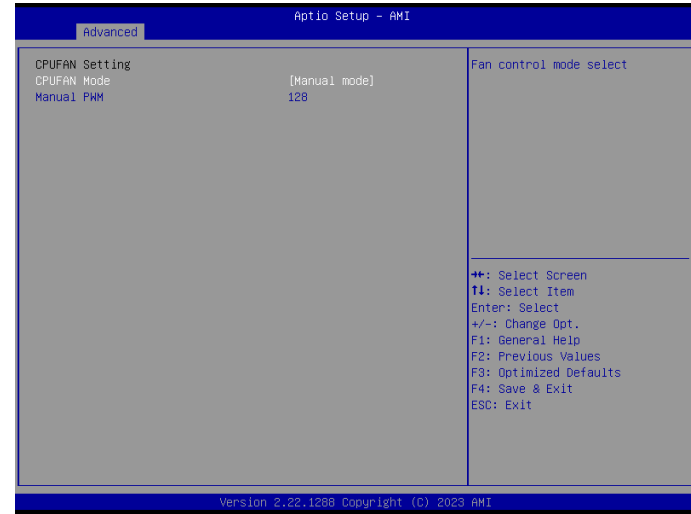

#### SYSFAN Mode

Fan control mode select.

#### Manual PWM

Fan will work with this manual PWM value (0~255 for 0%~100%).

## Network Stack Configuration

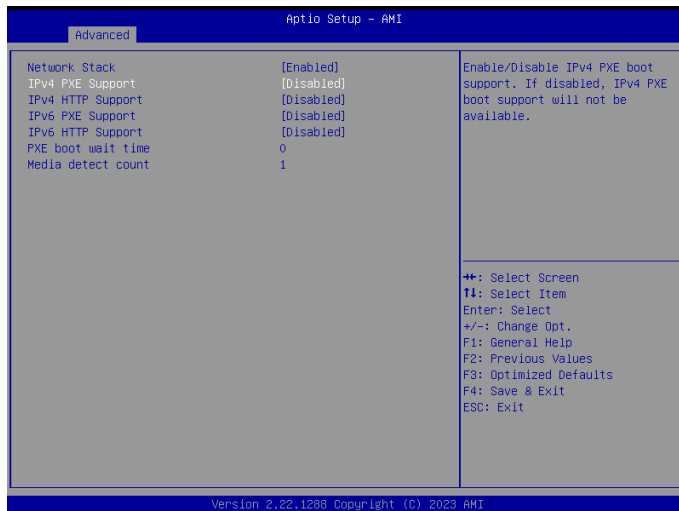

### Network Stack

Enable or disable UEFI network stack. More options will be available for configuration when enabled.

### Ipv4 PXE Support

Enable or disable IPv4 PXE support. If disabled, the IPv4 boot option will not be created.

### Ipv4 HTTP Support

Enable or disable IPv4 HTTP support. If disabled, the IPv4 boot option will not be created.

### Ipv6 PXE Support

Enable or disable IPv6 PXE support. If disabled, the IPv6 boot option will not be created.

### Ipv6HTTP Support

Enable or disable IPv6 HTTP support. If disabled, the IPv6 boot option will not be created.

### PXE boot wait time

Wait time in seconds to press ESC key to abort the PXE boot. Use either +/- or numeric keys to set the value.

### Media detect count

Number of times presence of media will be checked. Use either +/- or numeric keys to set the value.

## NVMe Configuration

This section is used to configure the NVMe devices. The options will become available once the system detects an installed NVMe device.

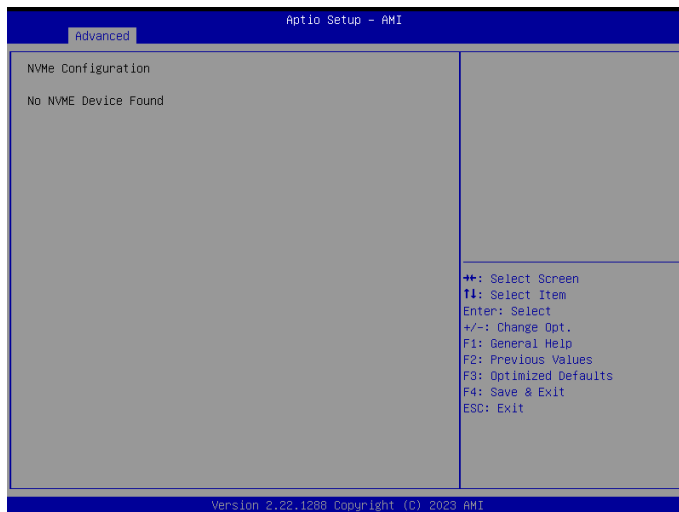

## Intel(R) Ethernet Controller I226-V / I219

This section is used to display information of the Intel Ethernet controller.

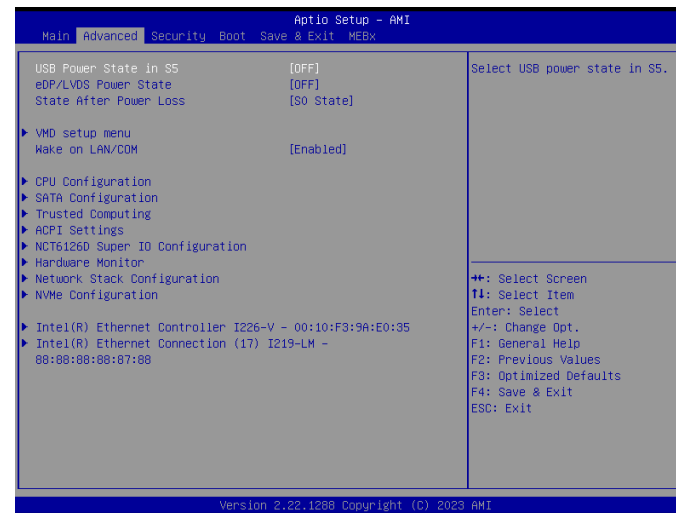



## Security

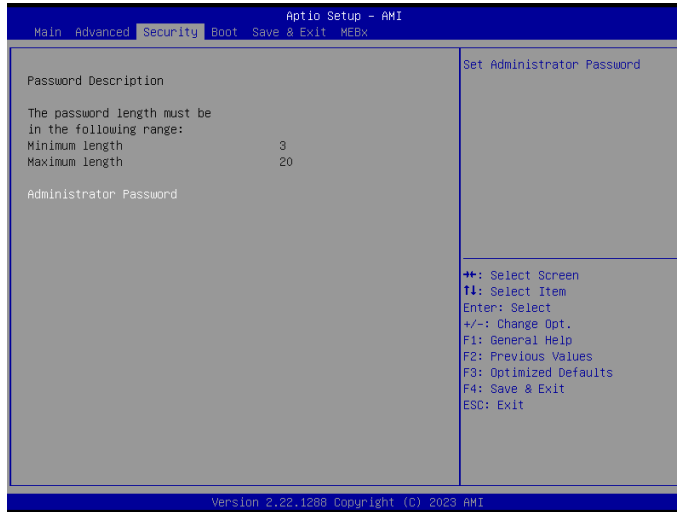

### Administrator Password

Select to reconfigure the administrator's password.

## Boot

This section is used to configure the boot features.

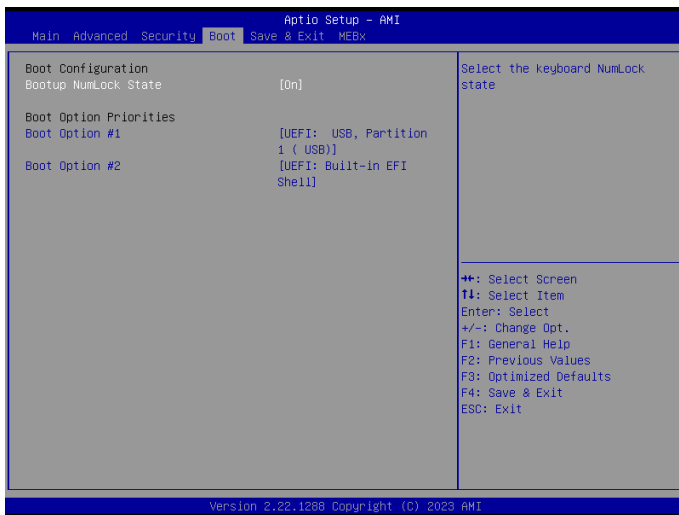

### Bootup NumLock State

This allows you to determine the default state of the numeric keypad. By default, the system boots up with NumLock on wherein the function of the numeric keypad is the number keys. When set to Off, the function of the numeric keypad is the arrow keys.

### Boot Option Priorities

Adjust the boot sequence of the system. Boot Option #1 is the first boot device that the system will boot from, next will be #2 and so forth.

## Save & Exit



### Save Changes and Exit

To save the changes and exit the Setup utility, select this field then press <Enter>. A dialog box will appear. Confirm by selecting Yes. You can also press <F4> to save and exit Setup.

### Discard Changes and Exit

To exit the Setup utility without saving the changes, select this field then press <Enter>. You may be prompted to confirm again before exiting. You can also press <ESC> to exit without saving the changes.

### Restore Defaults

To restore the BIOS to default settings, select this field then press <Enter>. A dialog box will appear. Confirm by selecting Yes.

### Boot Override

To bypass the boot sequence from the Boot Option List and boot from a particular device, select the desired device and press <Enter>.

## MEBx

This MEBx menu is allowed you to view and changed the MEBx congfruration.



### INTEL(R) ME Password

MEBx Login and configure AMT BIOS features.

# APPENDIX A: POWER CONSUMPTION

## Power Consumption Management

### Purpose

This chapter is to measure the maximum momentary current.

### Test Equipment

1. GWInstek PSW 30-36 360W DC power supply

### Device Under Test

DUT: Neu-X304-Q670W

### Test Procedure

1. Use DC power supply to measure the power consumption.
2. Full-Loading Test program: Win 10 x64 with BurnIn Test V10.2 (1007)

### Test Data

Mode	Test	+12V	+24V
S3 Mode	Current (A)	0.26A	0.17A
	Total Watts(W)	3.12W	4.08W
Idle Mode	Current (A)	1.7A	0.8A
	Total Watts(W)	20.4W	19.2W
Full-Loading Mode	Current (A)	8.0A	4.0A
	Total Watts(W)	96.0W	96.0W

BurnIn Item	Test	BurnIn Item	Test
2D Graphic	V	Network	V
3D Graphic	V	Serial Port	V
CPU	V	Sound	V
Disk(M.2)	V	Video Playback	V
GPGPU	V	USB Port x6	
(Connect load Device)	V		
Memory(RAM)	V		V

# APPENDIX B: GPIO PROGRAMMING GUIDE

## NCT6126D GPIO Programming Guide (PCB A)

GPIO (General Purpose Input/Output) pins are provided for custom system design. This appendix provides definitions and its default setting for the ten GPIO pins in the Neu-X304 series. The pin definition is shown in the following table:

Pin No.	GPIO mode	PowerOn Default	Address
1	VCC	-	-
2	GND	-	
3	GPO0	HIGH	A02h (Bit0)
4	GPO1	HIGH	A02h (Bit1)
5	GPO2	HIGH	A02h (Bit2)
6	GPO3	HIGH	A02h (Bit3)
7	GPI0		A02h (Bit4)
8	GPI1		A02h (Bit5)
9	GPI2		A02h (Bit6)
10	GPI3		A02h (Bit7)

Control the GPO 0/1/2/3 level from I/O port A02h bit0 / A02h bit1 / A02h bit2 / A02h bit3.  
The bit is Set/Clear indicated output High/Low.  
Read GPI 0/1/2/3 Set GPO3X.

## GPIO Programming Sample Code

```
#define GPO0                (0x01 << 0)
#define GPO1                (0x01 << 1)
#define GPO2                (0x01 << 2)
#define GPO3                (0x01 << 3)
#define GPO3X               outputb(0xA00, 0x03)
#define GPO0_HI             outputb(0xA02, GPO0)
#define GPO0_LO             outputb(0xA02, 0x00)
#define GPO1_HI             outputb(0xA02, GPO1)
#define GPO1_LO             outputb(0xA02, 0x00)
#define GPO2_HI             outputb(0xA02, GPO2)
#define GPO2_LO             outputb(0xA02, 0x00)
#define GPO3_HI             outputb(0xA02, GPO3)
#define GPO3_LO             outputb(0xA02, 0x00)
void main(void)
{
    GPO3X;
    GPO0_HI;
    GPO1_LO;
    GPO2_HI;
    GPO3_LO;
}
```

# APPENDIX C: WATCHDOG TIMER SETTING

## NCT6126D Watchdog Programming Guide

```
#define SUPERIO_PORT    0x2E
#define WDT_SET        0xF0
#define WDT_VALUE      0xF1

void main(void)
{
    #Enter SuperIO Configuration
        outportb(SUPERIO_PORT, 0x87);
        outportb(SUPERIO_PORT, 0x87);

    # Set LDN
        outportb(SUPERIO_PORT, 0x07);
        outportb(SUPERIO_PORT+1, 0x08);

    # Set WDT setting
        outportb(SUPERIO_PORT, WDT_SET);
        outportb(SUPERIO_PORT+1, 0x00); # Use the second
# Use the minute, change value to 0x08
    # Set WDT sec/min
        outportb(SUPERIO_PORT, WDT_VALUE);
        outportb(SUPERIO_PORT+1, 0x05); #Set 5 seconds
}
```