



NEXCOM International Co., Ltd.

Intelligent Digital Security

Video Intelligent Surveillance

NViS 66162/6602 Series

User Manual

CONTENTS

Preface

Copyright	iv
Disclaimer	iv
Acknowledgements	iv
Regulatory Compliance Statements	iv
Declaration of Conformity	iv
RoHS Compliance	v
Warranty and RMA	vi
Safety Information	viii
Installation Recommendations	viii
Safety Precautions	ix
Technical Support and Assistance	x
Conventions Used in this Manual	x
Global Service Contact Information	xi
Package Contents	xiii
Ordering Information	xiii

Chapter 1: Product Introduction

NViS 66162 Overview	1
Key Features	1
Hardware Specifications	2
NViS 6602 Overview	3
Key Features	3
Hardware Specifications	4
Knowing Your NViS 66xxx Series	5

Front Panel	5
Rear Panel	6
Mechanical Dimensions	8
NViS 66162	8
NViS 6602	9

Chapter 2: Jumpers and Connectors

Before You Begin	10
Precautions	10
Jumper Settings	11
Locations of the NViS66xxx Series Mainboard Jumpers and Connectors	12
External I/O Interfaces	13
HDMI 1.4b Connector	13
DisplayPort 1.4 and HDMI 2.0b Connectors	14
LAN1 Connector and USB Ports	15
LAN2 Connector and USB 3.2 Ports	16
Audio Jacks	17
USB 2.0 Ports	17
Internal I/O Interfaces	18
Power Connector	18
SATA Power Connectors	18
RAID SATA Connectors	19
M.2 Key B Slot	20
Front Panel Connector	21
DB9 Output	21

M.2 Key M Slot	22
GPIO Connector	23
POE UART Connector	23
PCIe Slot	24
Debug Connector	28
Fan Connectors	29
POE Connector	30
POE Connector	30
NViS 66162 Block Diagram	31
Locations of the NViS66612 POE Board Connectors	32
Internal I/O Interfaces	33
54V Power Connector	33
12V Power Connector	33
System Fan Connector	34
12V Power Connector	34
LAN Connectors	35
POE Board Block Diagram	36

Chapter 3: System Setup

Removing the Chassis Cover	37
Installing SO-DIMM DDR4 Memory Modules	39
Installing a CPU	41
Installing an M.2 Module (Key M 2280)	45
Installing an M.2 Module (Key B 2242)	47
Installing 3.5" Storage Device(s)	49
Installing a Graphic Card	51
Reassembling the Chassis	55

Chapter 4: BIOS Setup

About BIOS Setup	56
When to Configure the BIOS	56
Default Configuration	57
Entering Setup	57
Legends	57
BIOS Setup Utility	59
Main	59
Advanced	60
Chipset	77
Security	81
Boot	84
Save & Exit	85
MEBx	86

Appendix A: NViS 66162 Intel AMT Configuration

Appendix B: PCIe BUS Configuration

Appendix C: GPIO Instruction

Locating the GPIO Connector	93
Understanding GPIO Pin Definitions	93
ISO GPIO 4IN_2OUT Block Diagram	94
Basic Configuration	95

Appendix D: NViS 66162 RAID Configuration

Appendix E: Installing the System in a Rack

PREFACE

Copyright

This publication, including all photographs, illustrations and software, is protected under international copyright laws, with all rights reserved. No part of this manual may be reproduced, copied, translated or transmitted in any form or by any means without the prior written consent from NEXCOM International Co., Ltd.

Disclaimer

The information in this document is subject to change without prior notice and does not represent commitment from NEXCOM International Co., Ltd. However, users may update their knowledge of any product in use by constantly checking its manual posted on our website: <http://www.nexcom.com>. NEXCOM shall not be liable for direct, indirect, special, incidental, or consequential damages arising out of the use of any product, nor for any infringements upon the rights of third parties, which may result from such use. Any implied warranties of merchantability or fitness for any particular purpose is also disclaimed.

Acknowledgements

NViS 66162/6602 Series is a trademarks of NEXCOM International Co., Ltd. All other product names mentioned herein are registered trademarks of their respective owners.

Regulatory Compliance Statements

This section provides the FCC compliance statement for Class B devices and describes how to keep the system CE compliant.

Declaration of Conformity

FCC

This equipment has been tested and verified to comply with the limits for a Class B digital device, pursuant to Part 15 of FCC Rules. These limits are designed to provide reasonable protection against harmful interference when the equipment is operated in a commercial environment. This equipment generates, uses, and can radiate radio frequency energy and, if not installed and used in accordance with the instructions, may cause harmful interference to radio communications. Operation of this equipment in a residential area (domestic environment) is likely to cause harmful interference, in which case the user will be required to correct the interference (take adequate measures) at their own expense.

CE

The product(s) described in this manual complies with all applicable European Union (CE) directives if it has a CE marking. For computer systems to remain CE compliant, only CE-compliant parts may be used. Maintaining CE compliance also requires proper cable and cabling techniques.

RoHS Compliance



NEXCOM RoHS Environmental Policy and Status Update

NEXCOM is a global citizen for building the digital infrastructure. We are committed to providing green products and services, which are compliant with European Union RoHS (Restriction on Use of Hazardous Substance in Electronic Equipment) directive 2011/65/EU, to be your trusted green partner and to protect our environment.

RoHS restricts the use of Lead (Pb) < 0.1% or 1,000ppm, Mercury (Hg) < 0.1% or 1,000ppm, Cadmium (Cd) < 0.01% or 100ppm, Hexavalent Chromium (Cr6+) < 0.1% or 1,000ppm, Polybrominated biphenyls (PBB) < 0.1% or 1,000ppm, and Polybrominated diphenyl Ethers (PBDE) < 0.1% or 1,000ppm.

In order to meet the RoHS compliant directives, NEXCOM has established an engineering and manufacturing task force to implement the introduction of green products. The task force will ensure that we follow the standard NEXCOM development procedure and that all the new RoHS components and new manufacturing processes maintain the highest industry quality levels for which NEXCOM are renowned.

The model selection criteria will be based on market demand. Vendors and suppliers will ensure that all designed components will be RoHS compliant.

How to recognize NEXCOM RoHS Products?

For existing products where there are non-RoHS and RoHS versions, the suffix "(LF)" will be added to the compliant product name.

All new product models launched after January 2013 will be RoHS compliant. They will use the usual NEXCOM naming convention.

Warranty and RMA

NEXCOM Warranty Period

NEXCOM manufactures products that are new or equivalent to new in accordance with industry standard. NEXCOM warrants that products will be free from defect in material and workmanship for 2 years, beginning on the date of invoice by NEXCOM. HCP series products (Blade Server) which are manufactured by NEXCOM are covered by a three year warranty period.

NEXCOM Return Merchandise Authorization (RMA)

- Customers shall enclose the “NEXCOM RMA Service Form” with the returned packages.
- Customers must collect all the information about the problems encountered and note anything abnormal or, print out any on-screen messages, and describe the problems on the “NEXCOM RMA Service Form” for the RMA number apply process.
- Customers can send back the faulty products with or without accessories (manuals, cable, etc.) and any components from the card, such as CPU and RAM. If the components were suspected as part of the problems, please note clearly which components are included. Otherwise, NEXCOM is not responsible for the devices/parts.
- Customers are responsible for the safe packaging of defective products, making sure it is durable enough to be resistant against further damage and deterioration during transportation. In case of damages occurred during transportation, the repair is treated as “Out of Warranty.”
- Any products returned by NEXCOM to other locations besides the customers’ site will bear an extra charge and will be billed to the customer.

Repair Service Charges for Out-of-Warranty Products

NEXCOM will charge for out-of-warranty products in two categories, one is basic diagnostic fee and another is component (product) fee.

Repair Service Charges for Out-of-Warranty Products

NEXCOM will charge for out-of-warranty products in two categories, one is basic diagnostic fee and another is component (product) fee.

System Level

- Component fee: NEXCOM will only charge for main components such as SMD chip, BGA chip, etc. Passive components will be repaired for free, ex: resistor, capacitor.
- Items will be replaced with NEXCOM products if the original one cannot be repaired. Ex: motherboard, power supply, etc.
- Replace with 3rd party products if needed.
- If RMA goods can not be repaired, NEXCOM will return it to the customer without any charge.

Board Level

- Component fee: NEXCOM will only charge for main components, such as SMD chip, BGA chip, etc. Passive components will be repaired for free, ex: resistors, capacitors.
- If RMA goods can not be repaired, NEXCOM will return it to the customer without any charge.

Warnings

Read and adhere to all warnings, cautions, and notices in this guide and the documentation supplied with the chassis, power supply, and accessory modules. If the instructions for the chassis and power supply are inconsistent with these instructions or the instructions for accessory modules, contact the supplier to find out how you can ensure that your computer meets safety and regulatory requirements.

Cautions

Electrostatic discharge (ESD) can damage system components. Do the described procedures only at an ESD workstation. If no such station is available, you can provide some ESD protection by wearing an antistatic wrist strap and attaching it to a metal part of the computer chassis.

Safety Information

Before installing and using the device, note the following precautions:

- Read all instructions carefully.
- Do not place the unit on an unstable surface, cart, or stand.
- Follow all warnings and cautions in this manual.
- When replacing parts, ensure that your service technician uses parts specified by the manufacturer.
- Avoid using the system near water, in direct sunlight, or near a heating device.
- The load of the system unit does not solely rely for support from the rackmounts located on the sides. Firm support from the bottom is highly necessary in order to provide balance stability.
- The computer is provided with a battery-powered real-time clock circuit. There is a danger of explosion if battery is incorrectly replaced. Replace only with the same or equivalent type recommended by the manufacturer. Discard used batteries according to the manufacturer's instructions.

Installation Recommendations

Ensure you have a stable, clean working environment. Dust and dirt can get into components and cause a malfunction. Use containers to keep small components separated.

Adequate lighting and proper tools can prevent you from accidentally damaging the internal components. Most of the procedures that follow require only a few simple tools, including the following:

- A Philips screwdriver
- A flat-tipped screwdriver
- A grounding strap
- An anti-static pad

Using your fingers can disconnect most of the connections. It is recommended that you do not use needle-nose pliers to disconnect connections as these can damage the soft metal or plastic parts of the connectors.

Safety Precautions

1. Read these safety instructions carefully.
2. Keep this User Manual for later reference.
3. Disconnect this equipment from any AC outlet before cleaning. Use a damp cloth. Do not use liquid or spray detergents for cleaning.
4. For plug-in equipment, the power outlet socket must be located near the equipment and must be easily accessible.
5. Keep this equipment away from humidity.
6. Put this equipment on a stable surface during installation. Dropping it or letting it fall may cause damage.
7. The openings on the enclosure are for air convection to protect the equipment from overheating. **DO NOT COVER THE OPENINGS.**
8. Make sure the voltage of the power source is correct before connecting the equipment to the power outlet.
9. Place the power cord in a way so that people will not step on it. Do not place anything on top of the power cord. Use a power cord that has been approved for use with the product and that it matches the voltage and current marked on the product's electrical range label. The voltage and current rating of the cord must be greater than the voltage and current rating marked on the product.
10. All cautions and warnings on the equipment should be noted.
11. If the equipment is not used for a long time, disconnect it from the power source to avoid damage by transient overvoltage.
12. Never pour any liquid into an opening. This may cause fire or electrical shock.
13. Never open the equipment. For safety reasons, the equipment should be opened only by qualified service personnel.
14. If one of the following situations arises, get the equipment checked by service personnel:
 - a. The power cord or plug is damaged.
 - b. Liquid has penetrated into the equipment.
 - c. The equipment has been exposed to moisture.
 - d. The equipment does not work well, or you cannot get it to work according to the user's manual.
 - e. The equipment has been dropped and damaged.
 - f. The equipment has obvious signs of breakage.
15. Do not place heavy objects on the equipment.
16. The unit uses a three-wire ground cable which is equipped with a third pin to ground the unit and prevent electric shock. Do not defeat the purpose of this pin. If your outlet does not support this kind of plug, contact your electrician to replace your obsolete outlet.
17. **CAUTION: DANGER OF EXPLOSION IF BATTERY IS INCORRECTLY REPLACED. REPLACE ONLY WITH THE SAME OR EQUIVALENT TYPE RECOMMENDED BY THE MANUFACTURER. DISCARD USED BATTERIES ACCORDING TO THE MANUFACTURER'S INSTRUCTIONS.**

"ATTENTION: Risque d'explosion si la batterie est remplacée par un type incorrect. Mettre au rebus les batteries usagées selon les instructions."
18. This equipment is not suitable for use in locations where children are likely to be present.

Cet équipement ne convient pas à une utilisation dans des lieux pouvant accueillir des enfants.
19. Suitable for installation in Information Technology Rooms in accordance with Article 645 of the National Electrical Code and NFPA 75.

Peut être installé dans des salles de matériel de traitement de l'information conformément à l'article 645 du National Electrical Code et à la NFPA 75.

Technical Support and Assistance

1. For the most updated information of NEXCOM products, visit NEXCOM's website at www.nexcom.com.
2. For technical issues that require contacting our technical support team or sales representative, please have the following information ready before calling:
 - Product name and serial number
 - Detailed information of the peripheral devices
 - Detailed information of the installed software (operating system, version, application software, etc.)
 - A complete description of the problem
 - The exact wordings of the error messages

Warning!

1. Handling the unit: carry the unit with both hands and handle it with care.
2. Maintenance: to keep the unit clean, use only approved cleaning products or clean with a dry cloth.
3. CompactFlash: Turn off the unit's power before inserting or removing a CompactFlash storage card.
4. The ITE is to be connected only to PoE networks without routing to the outside plant.

Conventions Used in this Manual



Warning:

Information about certain situations, which if not observed, can cause personal injury. This will prevent injury to yourself when performing a task.



Caution:

Information to avoid damaging components or losing data.



Note:

Provides additional information to complete a task easily.

Global Service Contact Information

Headquarters

NEXCOM International Co., Ltd.

9F, No. 920, Zhongzheng Rd.,
Zhonghe District, New Taipei City, 23586,
Taiwan, R.O.C.
Tel: +886-2-8226-7786
Fax: +886-2-8226-7782
www.nexcom.com

Asia

Taiwan

NexAIoT Headquarters

Industry 4.0 and Cloud Services

12F, No.922, Zhongzheng Rd.,
Zhonghe District, New Taipei City,
23586, Taiwan, R.O.C.
Tel: +886-2-8226-7796
Fax: +886-2-8226-7926
Email: sales@nexaiot.com
www.nexaiot.com

NexAIoT Co., Ltd.

Taichung Office

16F, No.250, Sec.2, Chongde Rd.,
Beitun District,
Taichung City, 406, Taiwan, R.O.C.
Tel: +886-4-2249-1179
Fax: +886-4-2249-1172
Email: jacobhuang@nexaiot.com
www.nexaiot.com

NexCOBOT Taiwan Co., Ltd.

13F, No.916, Zhongzheng Rd.,
Zhonghe District,
New Taipei City, 23586, Taiwan, R.O.C.
Tel: +886-2-8226-7786
Fax: +886-2-8226-7926
Email: jennyshern@nexcobot.com
www.nexcobot.com

GreenBase Technology Corp.

13F, No.922, Zhongzheng Rd.,
Zhonghe District,
New Taipei City, 23586, Taiwan, R.O.C.
Tel: +886-2-8226-7786
Fax: +886-2-8226-7900
Email: vivianlin@nexcom.com.tw
www.nexcom.com.tw

DivioTec Inc.

19F-1A, No.97, Sec.4, ChongXin Rd.,
Sanhong District,
New Taipei City, 24161, Taiwan, R.O.C.
Tel: +886-2-8976-3077
Email: sales@diviotec.com
www.diviotec.com

AIoT Cloud Corp.

13F, No.922, Zhongzheng Rd.,
Zhonghe District,
New Taipei City, 23586, Taiwan, R.O.C.
Tel: +886-2-8226-7786
Fax: +886-2-8226-7782
Email: alantsai@aiotcloud.net
www.aiotcloud.dev

EMBUX TECHNOLOGY CO., LTD.

13F, No.916, Zhongzheng Rd.,
Zhonghe District,
New Taipei City, 23586, Taiwan, R.O.C.
Tel: +886-2-8226-7786
Fax: +886-2-8226-7782
Email: info@embux.com
www.embux.com

TMR TECHNOLOGIES CO., LTD.

13F, No.916, Zhongzheng Rd.,
Zhonghe District,
New Taipei City, 23586, Taiwan, R.O.C.
Tel: +886-2-8226-7786
Fax: +886-2-8226-7782
Email: services@tmrtek.com
www.tmrtek.com

China NEXSEC Incorporated

201, Floor 2, Unit 2, Building 15, Yard 3,
Gaolizhang Road, Haidian District,
Beijing, 100094, China
Tel: +86-10-5704-2680
Fax: +86-10-5704-2681
Email: marketing@nexsec.cn
www.nexsec.cn

NEXCOM Shanghai

Room 406-407, Building C, No 154, Lane 953,
Jianchuan Road, Minhang District,
Shanghai, 201108, China
Tel: +86-21-5278-5868
Fax: +86-21-3251-6358
Email: sales@nexcom.cn
www.nexcom.cn

NEXCOM Surveillance Technology Corp.

Floor 8, Building B3, Xiufeng Industrial Zone,
GanKeng Community, Buji Street,
LongGang District,
ShenZhen, 518112, China
Tel: +86-755-8364-7768
Fax: +86-755-8364-7738
Email: steveyang@nexcom.com.tw
www.nexcom.cn

NEXGOL Chongqing

1st Building No.999,
Star Boulevard, Yongchuan Dist,
Chongqing City, 402160, China
Tel: +86-23-4960-9080
Fax: +86-23-4966-5855
Email: sales@nexgol.com.cn
www.nexcom.cn

Beijing NexGemo Technology Co.,Ltd.

Room 205, No.1, Fazhan Rd.,
Beijing International Information Industry Base,
Changping District,
Beijing, 102206, China
Tel: +86-10-8072-2025
Fax: +86-10-8072-2022
Email: sales@nexgemo.cn
www.nexgemo.com

Japan

NEXCOM Japan

9F, Tamachi Hara Bldg.,
4-11-5, Shiba Minato-ku,
Tokyo, 108-0014, Japan
Tel: +81-3-5419-7830
Fax: +81-3-5419-7832
Email: sales@nexcom-jp.com
www.nexcom-jp.com

America

USA NEXCOM USA

46665 Fremont Blvd.,
Fremont CA 94538, USA
Tel: +1-510-656-2248
Fax: +1-510-656-2158
Email: sales@nexcom.com
www.nexcomusa.com

Package Contents

Before continuing, verify that the NViS66162/6602 package that you received is complete. Your package should have all the items listed in the following table.

No.	Item	Details
1	System	
2	CPU Cooler Box	Box
		CPU Cooler
		Thermal Grease
3	Accessories	PE Zipper Bag #8
		Cable Tie
		Terminal Block 10Pin
		PE Zipper Bag #3
		Flat Head Screw:F6#32Tx5mm Nylok NIGP * 8pcs
4	EPE Front*2 pcs	
5	EPE Rear*2 pcs	

Ordering Information

The following information below provides ordering information for the NViS 66162 and 6602 series.

NViS 66162 (P/N: 10C00661600X0)

2U desktop NVR with 16 port built-in PoE

NViS 6602 (P/N: 10C00660200X0)

2U desktop NVR with PCIe x16 support

CHAPTER 1: PRODUCT INTRODUCTION

NViS 66162 Overview



Key Features

- System 2U Desktop
- 12th Gen Intel® Core™ Platform
- HDD 2 bays 3.5" + 3.5" (support RAID 0,1)
- 1 x NVMe SSD, 1 x M.2 2242 SATA SSD
- Display 1 x DP 1.4, 1 x HDMI 2.0b, 1 x HDMI 1.4b
- DDR4 up to 64GB
- 2 x 2.5GbE Intel® Ethernet
- Audio (Line-in/Line-out/Mic)
- 16 x 10/100 PoE (240W max PSE)
- PCIe x16

Hardware Specifications

CPU Support

- Intel® Core™ i9-12900E/i7-12700E/i5-12500E/i3-12100E

Main Memory

- 2 x DDR4 SO-DIMM Non-ECC support up to 64G

Platform Control Hub

- Intel® Q670E

I/O Interface-Front

- 2 x Hot swappable 3.5" HDD bays
- 2 x USB 2.0 Type-A (per port output max 500mA)

I/O Interface-Rear

- 4 x USB 3.2 Gen1, Type-A (Per port output Max 900mA)
- 1 x DP 1.4 (4K@60Hz)
- 1 x HDMI 2.0b (4K@60Hz)
- 1 x HDMI 1.4b (4K@30Hz)
- 1 x Audio port (Line-in/Line-out/Mic)
- 2 x RJ45 LAN (2 x 2.5GbE)
- 1 x 4DI/2DO GPIO terminal block (optional)
- 16 x 10/100 PoE (240W max PSE)
- 1 x COM (RS232/RS485) Port

Expansions

- 2 x PCIe by 16 slots, support x16 lanes (riser slot could be compatible one x16 or two x8)

Storage

- Hot swappable 3.5" HDD x 2
- M.2 2280 Key M support NVMe Gen4
- M.2 2242 Key B support SATA3

Power Input

- Single PSU 600W

Dimensions

- 430mm (W) x 84mm (H) x 330mm (D)

Environment

- Operating temperature: Ambient with air flow: 0°C ~ 40°C
- Storage temperature: -20°C ~ 70°C
- Relative humidity: 0% ~ 90% (non-condensing)

Certifications

- CE approval
- FCC Class A
- UL compliance

NViS 6602 Overview



Key Features

- System 2U desktop
- 12th Gen Intel® Core™
- HDD 2bays 3.5" + 3.5" (support RAID 0,1)
- 1 x NVME SSD, 1 x M.2 2242 SATA SSD
- Display DP1.4, HDMI 2.0b x 1, HDMI 1.4b x 1
- DDR4 up to 64GB
- 2 x 2.5GbE Intel® Ethernet
- Audio in/out/Mic
- PCIe x16

Hardware Specifications

CPU Support

- Intel® Core™ i9-12900E/i7-12700E/i5-12500E/i3-12100E

Main Memory

- 2 x DDR4 SO-DIMM non-ECC support up to 64G
- Support OOB ECC in R680E

Platform Control Hub

- Intel® Q670E (option R680E)

I/O Interface-Front

- 2 x Hot swappable 3.5" HDD bays
- 2 x USB 2.0 Type-A (per port output Max 500mA)

I/O Interface-Rear

- 4 x USB 3.2 Gen1, Type-A (Per port output Max 900mA)
- 1 x DP 1.4 (4K@60)
- 1 x HDMI 2.0b (4K@60Hz)
- 1 x HDMI 1.4b (4K@30Hz)
- 1 x Audio port (Line in/Line out/MIC)
- 2 x RJ45 LAN (2 x 2.5Gps)
- 1 x 4DI/2DO GPIO terminal block (option)
- 1 x COM (RS232/RS485) Port

Expansions

- 2 x PCIe by 16 slots, support x 16 lanes (riser slot could be compatible one x16 or two x8)

Storage

- Hot swappable 3.5" HDD x 2
- M.2 2280 Key M support NVMe Gen4
- M.2 2242 Key B support SATA3

Power Input

- Single PSU 600W

Dimensions

- 430mm (W) x 84mm (H) x 330mm (D)

Environment

- Operating temperature: Ambient with air flow: 0°C ~ 40°C
- Storage temperature: -20°C ~ 70°C
- Relative humidity: 0% ~ 90% (non-condensing)

Certifications

- CE approval
- FCC Class A
- UL compliance

Knowing Your NViS 66xxx Series Front Panel

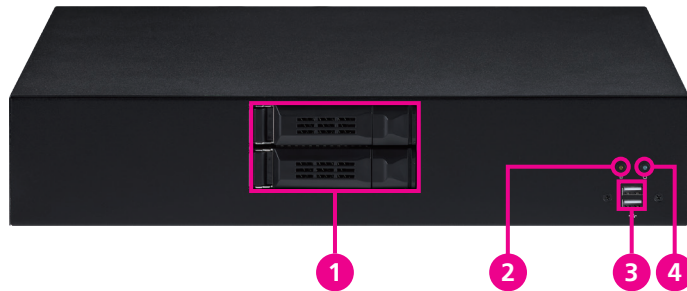

1. Swappable 3.5" HDD bays

Used to connect 3.5" hard disk drives.

2. Power LED Indicator

Lights up when power is on.

3. Dual USB 2.0 Ports

Used to connect USB 2.0 devices.

4. HDD Activity LED Indicator

Lights up when hard disk drive is operating.

Rear Panel

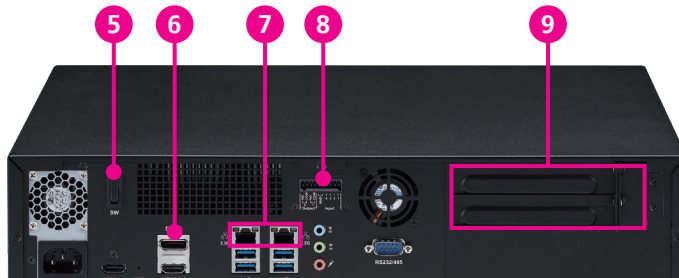

5. Power Switch

Used to power on the device.

6. DisplayPort 1.4 Connector

Supports DP1.4 displays.

7. 2.5 GbE RJ45

Used to connect the system to a local area network.

8. GPIO Terminal Block

Connects to an external device with a maximum load of 24V, 1.0A.

9. PCIe Slots

Supports x16 lanes (up to 1 x16 + 1 x4, 2 x8 + 1 x4)

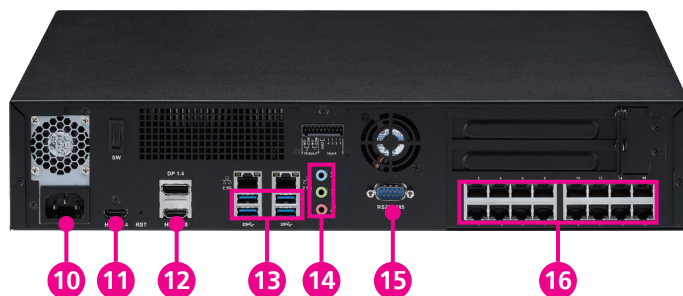

10. 100~240V AC Input

Used to plug a AC power cord.

11. HDMI 1.4b Connector

Supports HDMI 1.4b displays.

12. HDMI 2.0b Connector

Supports HDMI 2.0b displays.

13. USB3.2 Gen 1 Ports

Connects the system with USB 3.2 Gen1, Type-A devices.

14. Audio Connectors (Line in/Line out/MIC in)

Line in: Receives audio signal input

Line out: Provides audio signal output

MIC-in: Connects an external microphone

15. [COM Port](#)

Supports RS232 and RS485 compatible serial devices.

16. 10/100 PoE LAN Ports (NViS 66162 only)

Enables communication among network clients and delivers power using the same RJ45 to PoE-enabled edge devices. 16ch PoE ports 10/100 Mbps, compliance with total 240W max.

Mechanical Dimensions

NViS 66162

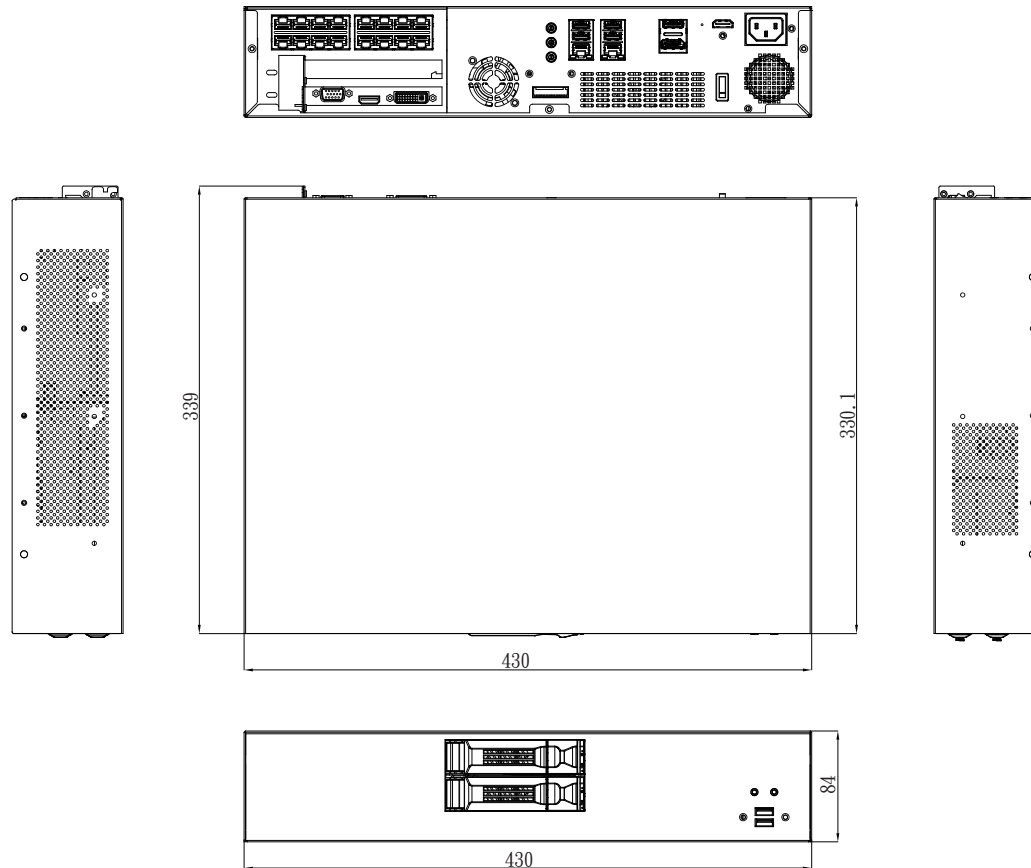

NViS 6602

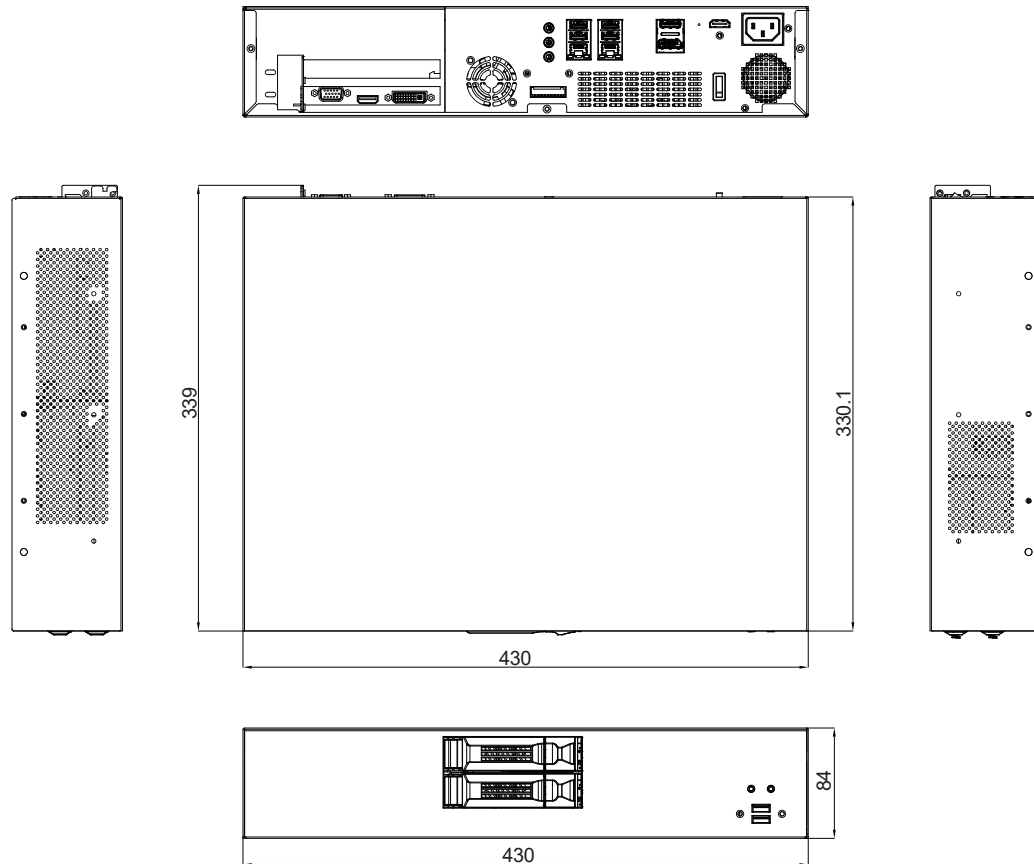

CHAPTER 2: JUMPERS AND CONNECTORS

This chapter describes how to set the jumpers and connectors on the NViS 66xxx series motherboard.

Before You Begin

- Ensure you have a stable, clean working environment. Dust and dirt can get into components and cause a malfunction. Use containers to keep small components separated.
- Adequate lighting and proper tools can prevent you from accidentally damaging the internal components. Most of the procedures that follow require only a few simple tools, including the following:
 - A Philips screwdriver
 - A flat-tipped screwdriver
 - A set of jewelers screwdrivers
 - A grounding strap
 - An anti-static pad
- Using your fingers can disconnect most of the connections. It is recommended that you do not use needle-nosed pliers to disconnect connections as these can damage the soft metal or plastic parts of the connectors.
- Before working on internal components, make sure that the power is off. Ground yourself before touching any internal components, by touching a metal object. Static electricity can damage many of the electronic components. Humid environments tend to have less static electricity than

dry environments. A grounding strap is warranted whenever danger of static electricity exists.

Precautions

Computer components and electronic circuit boards can be damaged by discharges of static electricity. Working on computers that are still connected to a power supply can be extremely dangerous.

Follow the guidelines below to avoid damage to your computer or yourself:

- Always disconnect the unit from the power outlet whenever you are working inside the case.
- If possible, wear a grounded wrist strap when you are working inside the computer case. Alternatively, discharge any static electricity by touching the bare metal chassis of the unit case, or the bare metal body of any other grounded appliance.
- Hold electronic circuit boards by the edges only. Do not touch the components on the board unless it is necessary to do so. Don't flex or stress the circuit board.
- Leave all components inside the static-proof packaging that they shipped with until they are ready for installation.
- Use correct screws and do not over tighten screws.

Jumper Settings

A jumper is the simplest kind of electric switch. It consists of two metal pins and a cap. When setting the jumpers, ensure that the jumper caps are placed on the correct pins. When the jumper cap is placed on both pins, the jumper is short. If you remove the jumper cap, or place the jumper cap on just one pin, the jumper is open.

Refer to the illustrations below for examples of what the 2-pin and 3-pin jumpers look like when they are short (on) and open (off).

Two-Pin Jumpers: Open (Left) and Short (Right)

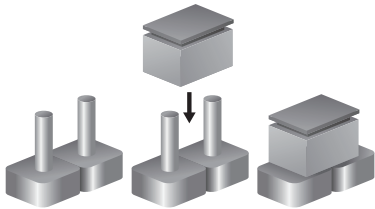

Three-Pin Jumpers: Pins 1 and 2 are Short

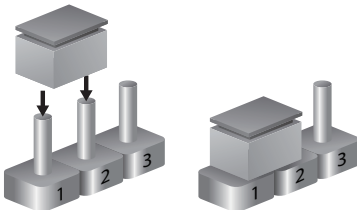

Locations of the NViS66xxx Series Mainboard Jumpers and Connectors

The figure below shows the location of the NViS66xxx series mainboard jumpers and connectors. Refer to the figure below for detailed information on pin settings and definitions marked in pink.

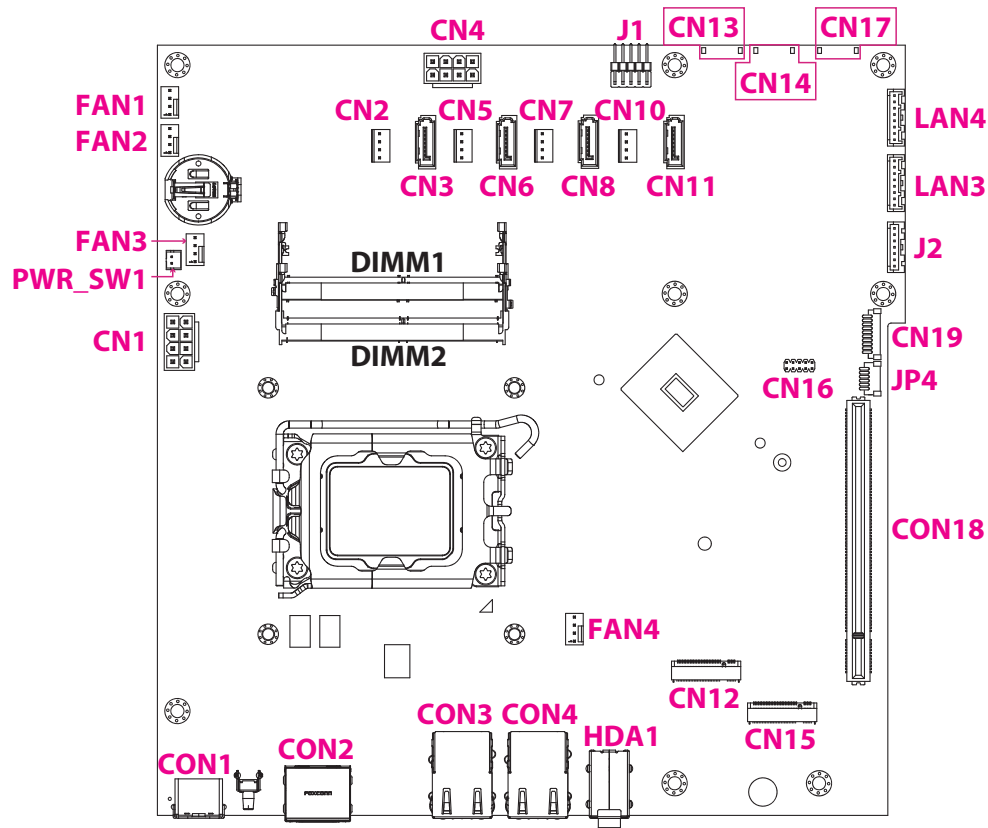

External I/O Interfaces

HDMI 1.4b Connector

Connector location: CON1

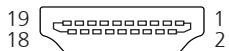

Pin	Definition	Pin	Definition
1	HDMI14_CM_DP2	3	HDMI14_CM_DN2
2	GND	4	HDMI14_CM_DP1
6	HDMI14_CM_DN1	5	GND
7	HDMI14_CM_DP0	9	HDMI14_CM_DN0
8	GND	10	HDMI14_CM_CKP
12	HDMI14_CM_CKN	11	GND
13	CEC	14	NC
15	HDMI14_SCL	16	HDMI14_SDA
17	GND	18	V5P0_HDMI0
19	HDMI14_HPD		

DisplayPort 1.4 and HDMI 2.0b Connectors

Connector location: CON2

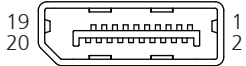

Pin	Definition	Pin	Definition
1	DP14_TX_CM_P0	2	GND1
3	DP14_TX_CM_N0	4	DP14_TX_CM_P1
5	GND2	6	DP14_TX_CM_N1
7	DP14_TX_CM_P2	8	GND3
9	DP14_TX_CM_N2	10	DP14_TX_CM_P3
11	GND4	12	DP14_TX_CM_N3
13	DP14_OB_AUX_EN	14	GND
15	DP14_AUXP_SNK	16	GND5
17	DP14_AUXN_SNK	18	DP14_HPD_SNK
19	GND	20	V3P3_DP14

Pin	Definition	Pin	Definition
21	HDMI20_CRLS_DP2	23	HDMI20_CRLS_DN2
22	GND	24	HDMI20_CRLS_DP1
26	HDMI20_CRLS_DN1	25	GND
27	HDMI20_CRLS_DP0	29	HDMI20_CRLS_DN0
28	GND	30	HDMI20_CRLS_CK1
32	HDMI20_CRLS_CKN	31	GND
33	CEC	34	NC
35	HDMI20_CRLS_SCL	36	HDMI20_CRLS_SDA
37	GND	38	V5P0_HDMI1
39	HDMI20_RT_HPD_SNK		

LAN1 Connector and USB Ports

Connector type: RJ45 port with LEDs

Dual USB3.2 Gen 1 Type A ports

Connector location: CON3

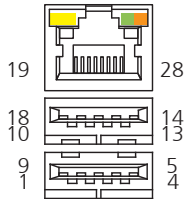

Pin	Definition	Pin	Definition
1	V5P0_USB3_P12	2	USB2_1_DN_CM
3	USB2_1_DP_CM	4	GND9
5	USB31_1_RXN_CM	6	USB31_1_RXP_CM
7	GND11	8	USB31_1_TXN_CM
9	USB31_1_TXP_CM	10	V5P0_USB3_P12
11	USB2_2_DN_CM	12	USB2_2_DP_CM
13	GND10	14	USB31_2_RXN_CM
15	USB31_2_RXP_CM	16	GND12
17	USB31_2_TXN_CM	18	USB31_2_TXP_CM
19	GND	20	LAN1_PHY_P0
21	LAN1_PHY_N0	22	LAN1_PHY_P1
23	LAN1_PHY_N1	24	LAN1_PHY_P2
25	LAN1_PHY_N2	26	LAN1_PHY_P3
27	LAN1_PHY_N3	28	GND13
29	V3P3A_LAN1	30	LAN1_PHY_LED_ACT_N_R
31	LAN1_PHY_LED_1000_N_R	32	LAN1_PHY_LED_2500_N_R

Act	Status
Blinking Yellow	Data activity
Off	No activity

Link	Status
Steady Green	2.5Gbp/s network link
Steady Orange	1Gbp/s network link
Off	100Mbps or no link

LAN2 Connector and USB 3.2 Ports

Connector type: RJ45 port with LEDs

Dual USB3.2 Gen 1 Type A ports

Connector location: CON4

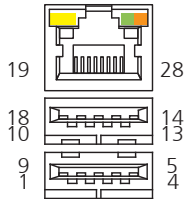

Pin	Definition	Pin	Definition
1	V5P0_USB3_P34	2	USB2_3_DN_CM
3	USB2_3_DP_CM	4	GND9
5	USB31_3_RXN_CM	6	USB31_3_RXP_CM
7	GND11	8	USB31_3_TXN_CM
9	USB31_3_TXP_CM	10	V5P0_USB3_P34
11	USB2_4_DN_CM	12	USB2_4_DP_CM
13	GND10	14	USB31_4_RXN_CM
15	USB31_4_RXP_CM	16	GND12
17	USB31_4_TXN_CM	18	USB31_4_TXP_CM
19	GND	20	LAN2_PHY_P0
21	LAN2_PHY_N0	22	LAN2_PHY_P1
23	LAN2_PHY_N1	24	LAN2_PHY_P2
25	LAN2_PHY_N2	26	LAN2_PHY_P3
27	LAN2_PHY_N3	28	GND13
29	V3P3A_LAN2	30	LAN2_PHY_LED_ACT_N_R
31	LAN2_PHY_LED_1000_N_R	32	LAN2_PHY_LED_2500_N_R

Act	Status
Blinking Yellow	Data activity
Off	No activity

Link	Status
Blinking Green	2.5Gbp/s network link
Blinking Orange	1Gbp/s network link
Off	100Mbps or no link

Audio Jacks

Connector type: Line In, Line Out, MIC

Connector location: HDA1



Line In



Line Out



MIC

Pin	Definition	Pin	Definition
1	AGND_P	2	MIC_OUT_L_C
3	AGND_P	4	MIC1_JD
5	MIC_OUT_R_C		
22	LINE_OUT_L_C	23	AGND_G
24	FRONT_JD	25	LINE_OUT_R_C
32	LINE-L_C	33	AGND_B
34	LINEIN1_JD	35	LINE-R_C

USB 2.0 Ports

Connector type: USB 2.0 Type A ports

Connector location: J1

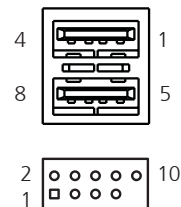

Pin	Definition	Pin	Definition
1	V5P0_USB2_HDR	2	V5P0_USB2_HDR
3	USB2_5_DN_CM	4	USB2_6_DN_CM
5	USB2_5_DP_CM	6	USB2_6_DP_CM
7	GND	8	GND
9	X	10	N/C

Internal I/O Interfaces

Power Connector

Connector location: CN1



Pin	Definition	Pin	Definition
1	GND1	2	GND2
3	GND3	4	GND4
5	V12P0A_2_1	6	V12P0A_2_2
7	V12P0A_2_3	8	V12P0A_2_4

SATA Power Connectors

Connector location: CN2, CN5, CN7, CN10



CN2

Pin	Definition	Pin	Definition
1	V12P0_HDD0	2	GND
3	GND	4	V5P0_HDD0

CN5

Pin	Definition	Pin	Definition
1	V12P0_HDD1	2	GND
3	GND	4	V5P0_HDD1

CN7

Pin	Definition	Pin	Definition
1	V12P0_HDD2	2	GND
3	GND	4	V5P0_HDD2

CN10

Pin	Definition	Pin	Definition
1	V12P0_HDD3	2	GND
3	GND	4	V5P0_HDD3

RAID SATA Connectors

Connector location: CN3, CN6, CN8, CN11

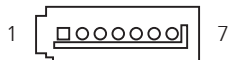

CN3 (Port0)

Pin	Definition	Pin	Definition
1	GND1	2	RSATA_CON0_TXP
3	RSATA_CON0_TXN	4	GND2
5	RSATA_CON0_RXN	6	RSATA_CON0_RXP
7	GND3		

CN6 (Port1)

Pin	Definition	Pin	Definition
1	GND1	2	RSATA_CON1_TXP
3	RSATA_CON1_TXN	4	GND2
5	RSATA_CON1_RXN	6	RSATA_CON1_RXP
7	GND3		

CN8 (Port2)

Pin	Definition	Pin	Definition
1	GND1	2	RSATA_CON2_TXP
3	RSATA_CON2_TXN	4	GND2
5	RSATA_CON2_RXN	6	RSATA_CON2_RXP
7	GND3		

CN11 (Port3)

Pin	Definition	Pin	Definition
1	GND1	2	RSATA_CON3_TXP
3	RSATA_CON3_TXN	4	GND2
5	RSATA_CON3_RXN	6	RSATA_CON3_RXP
7	GND3		

M.2 Key B Slot

Connector type: M.2 Key B 2280 slot (SATA/USB3.0)

Connector location: CN12

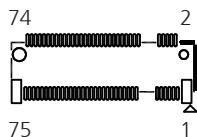

Pin	Definition	Pin	Definition
1	M2B_CONFIG_3	2	V3P3_M2B_1
3	GND1	4	V3P3_M2B_2
5	GND2	6	M2B_SSD_FULL_PWR_OFF_N
7	M2B_USB2_DP	8	M2B_PLN_N
9	M2B_USB2_DN	10	M2B_SATA_LED_N
11	GND3	20	GPIO_5/RFU_1.8V
21	M2B_CONFIG_0	22	GPIO_6/RFU_1.8V
23	WAKE_ON_WWA#_1.8V	24	GPIO_7/RFU_1.8V
25	DPR_1.8V	26	W_DISABLE2#_1.8V
27	GND4	28	GPIO_8/RFU_1.8V
29	M2B_PER1N	30	UIM-RESET
31	M2B_PER1P	32	UIM-CLK
33	GND5	34	UIM-DATA
35	M2B_PET1N	36	UIM-PWR
37	M2B_PET1P	38	DEVSLP
39	GND6	40	GPIO_0
41	M2B_PER0P	42	GPIO_1

Pin	Definition	Pin	Definition
43	M2B_PER0N	44	GPIO_2
45	GND7	46	GPIO_3
47	M2B_PET0N	48	GPIO_4
49	M2B_PET0P	50	M2B_PCI_RST_N
51	GND8	52	CLKREQ#
53	REFCLKn	54	PCIE_WAKE#
55	REFCLKp	56	M2B_SMDAT
57	GND9	58	M2B_SMCLK
59	ANTCTL0_1.8V	60	COEX3_1.8V
61	ANTCTL1_1.8V	62	COEX_TXD_1.8V
63	ANTCTL2_1.8V	64	COEX_RXD_1.8V
65	ANTCTL3_1.8V	66	SIM_DETECT
67	LTE_RST#_1.8V	68	M2B_SUSCLK
67	M2B_CONFIG_1	70	V3P3_M2B_3
71	GND10	72	V3P3_M2B_4
73	GND11	74	V3P3_M2B_5
75	M2B_CONFIG_2		

Front Panel Connector

Connector type: Wire to BD connector

Connector location: CN13



Pin	Definition	Pin	Definition
1	V3P3A	2	V3P3_DSW
3	GND	4	RSTBTN_N
5	PWRBTN_N_S2	6	GND
7	LED_HDD_PU	8	LED_HDD_LOGIC_N
9	LED_PWR_PU	10	LED_PWR_LOGIC_N

DB9 Output

Connector type: Wire to BD connector

Connector location: CN14



Pin	Definition	Pin	Definition
1	GND	2	HDR_RI_N
3	HDR_CTS_N	4	HDR_RTS_N
5	HDR_DSR_N	6	GND
7	HDR_DTR_N	8	HDR_TXD
9	HDR_RXD	10	HDR_DCD_N

M.2 Key M Slot

Connector type: M.2 Key M 2280 slot (PCIe Gen4 x4)

Connector location: CN15

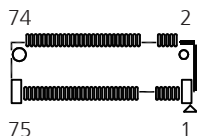

Pin	Definition	Pin	Definition
1	GND1	2	V3P3A_M2M_1
3	GND2	4	V3P3A_M2M_2
5	NVME_RXN3	6	M2M_FULL_PWROFF_N
7	NVME_RXP3	8	M2M_PLN_N
9	GND3	10	M2M_LED_OC
11	NVME_TXN3	12	V3P3A_M2M_6
13	NVME_TXP3	14	V3P3A_M2M_7
15	GND4	16	V3P3A_M2M_8
17	NVME_RXN2	18	V3P3A_M2M_9
19	NVME_RXP2	20	NC2
21	GND5	22	NC3
23	NVME_TXN2	24	NC4
25	NVME_TXP2	26	NC5
27	GND6	28	NC6
29	NVME_RXN1	30	NC7
31	NVME_RXP1	32	NC8
33	GND7	34	NC9

Pin	Definition	Pin	Definition
35	NVME_TXN1	36	NC10
37	NVME_TXP1	38	M2M_DEVSLP
39	GND8	40	M2M_SMBCLK_V1P8
41	NVME_RXN0	42	M2M_SMBDAT_V1P8
43	NVME_RXP0	44	M2M_ALERT_N_V1P8
45	GND9	46	NC14
47	NVME_TXN0	48	NC15
49	NVME_TXP0	50	M2M_PERST_N
51	GND10	52	M2M_NVME_PCH_CLKREQ_N
53	NVME_CLKN	54	M2M_WAKE_N
55	NVME_CLKP	56	NC16
57	GND11	58	NC17
67	NC26	68	M2M_SUSCLK
69	M2M_SSD_DETECT	70	V3P3A_M2M_3
71	GND12	72	V3P3A_M2M_4
73	GND13	74	V3P3A_M2M_5
75	M2M_Mount_Detect		

GPIO Connector

Connector location: CN16



Pin	Definition	Pin	Definition
1	V5P0_4I4O	2	GND
3	PIO_IN_80	4	PIO_OUT_84
5	PIO_IN_81	6	PIO_OUT_85
7	PIO_IN_82	8	PIO_OUT_86
9	PIO_IN_83	10	PIO_OUT_87

POE UART Connector

Connector type: Wire to BD connector

Connector location: CN17



Pin	Definition	Pin	Definition
1	GND	2	SATA_SGPIO_DOUT1
3	SATA_SGPIO_DOUT0	4	SATA_SGPIO_LOAD
5	SATA_SGPIO_CLK	6	DUG_SDA
7	DUG_SCLK	8	DUG_RXD
9	DUG_TXD	10	V3P3A

PCIe Slot

Connector type: PCIe Gen 4, supports riser card Gen 4 1 x16 or 2 x8

Connector location: CN18



Pin	Definition	Pin	Definition
A1	GND	A2	V12P0_SLOT_1
A3	V12P0_SLOT_2	A4	GND_1
A5	TCK	A6	TDI
A7	TDO	A8	TMS
A9	V3P3S_SLOT_1	A10	V3P3S_SLOT_2
A11	PEG_RST_N	A12	GND_2
A13	PEG_SLOT_CLKP	A14	PEG_SLOT_CLKN
A15	GND_3	A16	CPU_PEG_RXP0
A17	CPU_PEG_RXN0	A18	GND_4
A19	PEG_PWR_EN	A20	GND_5
A21	CPU_PEG_RXP1	A22	CPU_PEG_RXN1

Pin	Definition	Pin	Definition
A23	GND_6	A24	GND_7
A25	CPU_PEG_RXP2	A26	CPU_PEG_RXN2
A27	GND_8	A28	GND_9
A29	CPU_PEG_RXP3	A30	CPU_PEG_RXN3
A31	GND_10	A32	PEG_PWR_OK
A33	RSVD3	A34	GND_11
A35	CPU_PEG_RXP4	A36	CPU_PEG_RXN4
A37	GND_12	A38	GND_13
A39	CPU_PEG_RXP5	A40	CPU_PEG_RXN5
A41	GND_14	A42	GND_15

Pin	Definition	Pin	Definition
A43	CPU_PEG_RXP6	A44	CPU_PEG_RXN6
A45	GND_16	A46	GND_17
A47	CPU_PEG_RXP7	A48	CPU_PEG_RXN7
A49	GND_18	A50	RSVD4
A51	GND_19	A52	CPU_PEG_RXP8
A53	CPU_PEG_RXN8	A54	GND_20
A55	GND_21	A56	CPU_PEG_RXP9
A57	CPU_PEG_RXN9	A58	GND_22
A59	GMD_23	A60	CPU_PEG_RXP10
A61	CPU_PEG_RXN10	A62	_GND_24

Pin	Definition	Pin	Definition
A63	GND_25	A64	CPU_PEG_RXP11
A65	CPU_PEG_RXN11	A66	GND_26
A67	GND_27	A68	CPU_PEG_RXP12
A69	CPU_PEG_RXN12	A70	GND_28
A71	GND_29	A72	CPU_PEG_RXP13
A73	CPU_PEG_RXN13	A74	GND_30
A75	GND_31	A76	CPU_PEG_RXP14
A77	CPU_PEG_RXN14	A78	GND_32
A79	GND_33	A80	CPU_PEG_RXP15
A81	CPU_PEG_RXN15	A82	GND_34

Pin	Definition	Pin	Definition
B1	V12P0_SLOT_3	B2	V12P0_SLOT_4
B3	V12P0_SLOT	B4	GND_35
B5	SLOT1_SMCLK	B6	SLOT1_SMSDA
B7	GND_36	B8	V3P3S_SLOT_3
B9	TRST#	B10	V3P3A_SLOT
B11	PEG_WAKE_N	B12	PEG_B12
B13	GND_37	B14	PEG_TXP0
B15	PEG_TXN0	B16	GND_38
B17	PEG_PRSNT2_N	B18	GND_39
B19	PEG_TXP1	B20	PEG_TXN1
B21	GND_40	B22	GND_41

Pin	Definition	Pin	Definition
B23	PEG_TXP2	B24	PEG_TXN2
B25	GND_42	B26	GND_43
B27	PEG_TXP3	B28	PEG_TXN3
B29	GND_44	B30	PEG_SEL_N
B31	PEG_PRSNT2_N	B32	GND_45
B33	PEG_TXP4	B34	PEG_TXN4
B35	GND_46	B36	GND_47
B37	PEG_TXP5	B38	PEG_TXN5
B39	GND_48	B40	GND_49
B41	PEG_TXP6	B42	PEG_TXN6

Pin	Definition	Pin	Definition
B43	GND_50	B44	GND_51
B45	PEG_TXP7	B46	PEG_TXN7
B47	GND_52	B48	PEG_PRSNT2_N
B49	GND_53	B50	PEG_TXP8
B51	PEG_TXN8	B52	GND_54
B53	GND_55	B54	PEG_TXP9
B55	PEG_TXN9	B56	GND_56
B57	GND_57	B58	PEG_TXP10
B59	PEG_TXN10	B60	GND_58
B61	GND_59	B62	PEG_TXP11

Pin	Definition	Pin	Definition
B63	PEG_TXN11	B64	GND_60
B65	GND_61	B66	PEG_TXP12
B67	PEG_TXN12	B68	GND_62
B69	GND_63	B70	PEG_TXP13
B71	PEG_TXN13	B72	GND_64
B73	GND_65	B74	PEG_TXP14
B75	PEG_TXN14	B76	GND_66
B77	GND_67	B78	PEG_TXP15
B79	PEG_TXN15	B80	GND_68
B81	PEG_PRSNT2_2nd_Slot_N	B82	PEG_SEL_X8_X16

Debug Connector

Connector type: Wire to BD connector

Connector location: CN19



Pin	Definition	Pin	Definition
1	V3P3A	2	DBG_ESPI_RST0_N
3	DBG_ESPI_IO0	4	DBG_ESPI_IO1
5	DBG_ESPI_IO2	6	DBG_ESPI_IO3
7	DBG_ESPI_CS0_N	8	DBG_ESPI_CLK
9	DBG_PLTRST_N	10	GND

Fan Connectors

Connector location: FAN1, FAN2, FAN3, FAN4



FAN1

Pin	Definition	Pin	Definition
1	GND	2	V12P0_FANG1
3	SYS2_FAN_TACO	4	SYS2_FAN_PWM

FAN2

Pin	Definition	Pin	Definition
1	GND	2	V12P0_FANG1
3	SYS1_FAN_TACO	4	SYS1_FAN_PWM

FAN3

Pin	Definition	Pin	Definition
1	GND	2	V12P0S
3	CPU_FAN_TACO	4	CPU_FAN_PWM

FAN4

Pin	Definition	Pin	Definition
1	GND	2	V12P0_FANG2
3	SYS3_FAN_TACO	4	SYS3_FAN_PWM

POE Connector

Connector type: Wire to BD connector

Connector location: J2



Pin	Definition	Pin	Definition
1	V12POE	2	V12POE
3	POE_RXD_IN	4	POE_TXD_OUT
5	POE_RST_OUT	6	GND
7	GND	8	

POE Connector

Connector type: Wire to BD connector

Connector location: J2



Pin	Definition	Pin	Definition
1	GND	2	PWRBTN_N

NViS 66162 Block Diagram

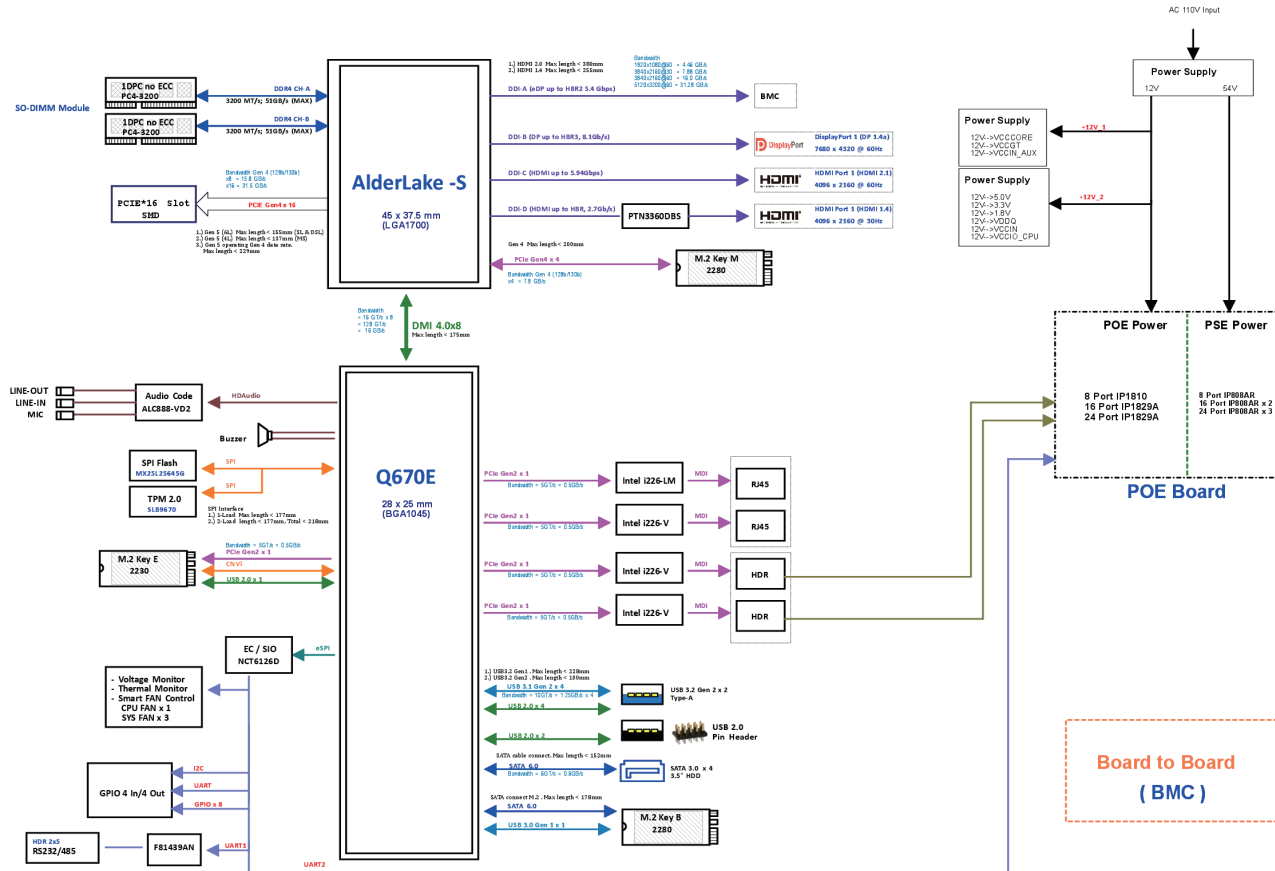

Locations of the NViS66612 POE Board Connectors

The figure below shows the location of the NViS66162 POE board connectors. Refer to the figure below for detailed information on pin settings and definitions marked in pink.

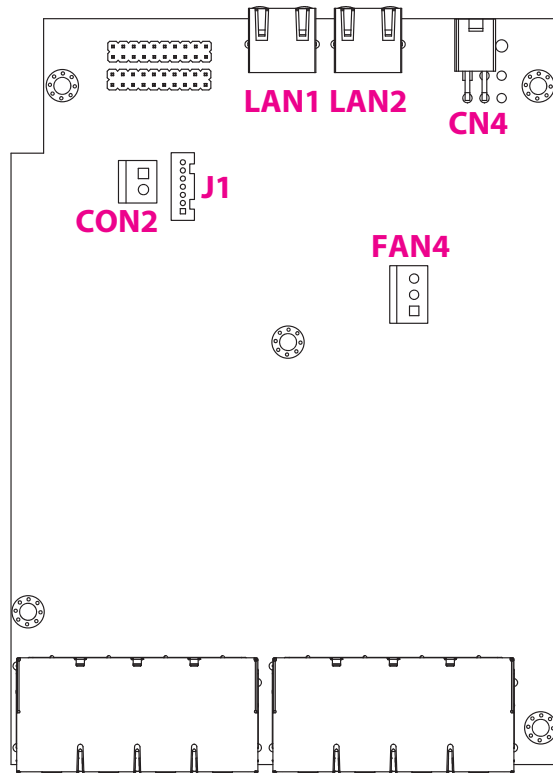

Internal I/O Interfaces

54V Power Connector

Connector type: 54V power in connector

Connector location: CN4



Pin	Definition	Pin	Definition
1	P_GND_D	2	P_GND_D
3	DC_JACK_IN_P	4	DC_JACK_IN_P

12V Power Connector

Connector type: 12V power in connector

Connector location: CON2



Pin	Definition	Pin	Definition
1	P12V_GND	2	V12POE

System Fan Connector

Connector location: FAN4



Pin	Definition	Pin	Definition
1	V54_POE	2	Power_Module_EN
3	POE_GND	4	---

12V Power Connector

Connector type: 12V power in connector

Connector location: J1

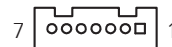

Pin	Definition	Pin	Definition
1	GND	2	GND
3	MCU_RST_N	4	MCU_UART_TX
5	MCU_UART_RX	6	V12POE
7	V12POE	8	---

LAN Connectors

Connector type: RJ45 port with LEDs

Connector location: LAN1, LAN2

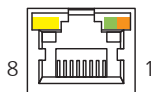

LAN1

Pin	Definition	Pin	Definition
1	MDI1P	2	MDI1N
3	MDI2P	4	MDI3P
5	MDI3N	6	MDI2N
7	MDI4P	8	MDI4N
9	LED2-/Y	10	LED2+/Y
11	LED1-/Y	12	LED1+/Y

LAN2

Pin	Definition	Pin	Definition
1	MDI1P	2	MDI1N
3	MDI2P	4	MDI3P
5	MDI3N	6	MDI2N
7	MDI4P	8	MDI4N
9	LED2-/Y	10	LED2+/Y
11	LED1-/Y	12	LED1+/Y

POE Board Block Diagram

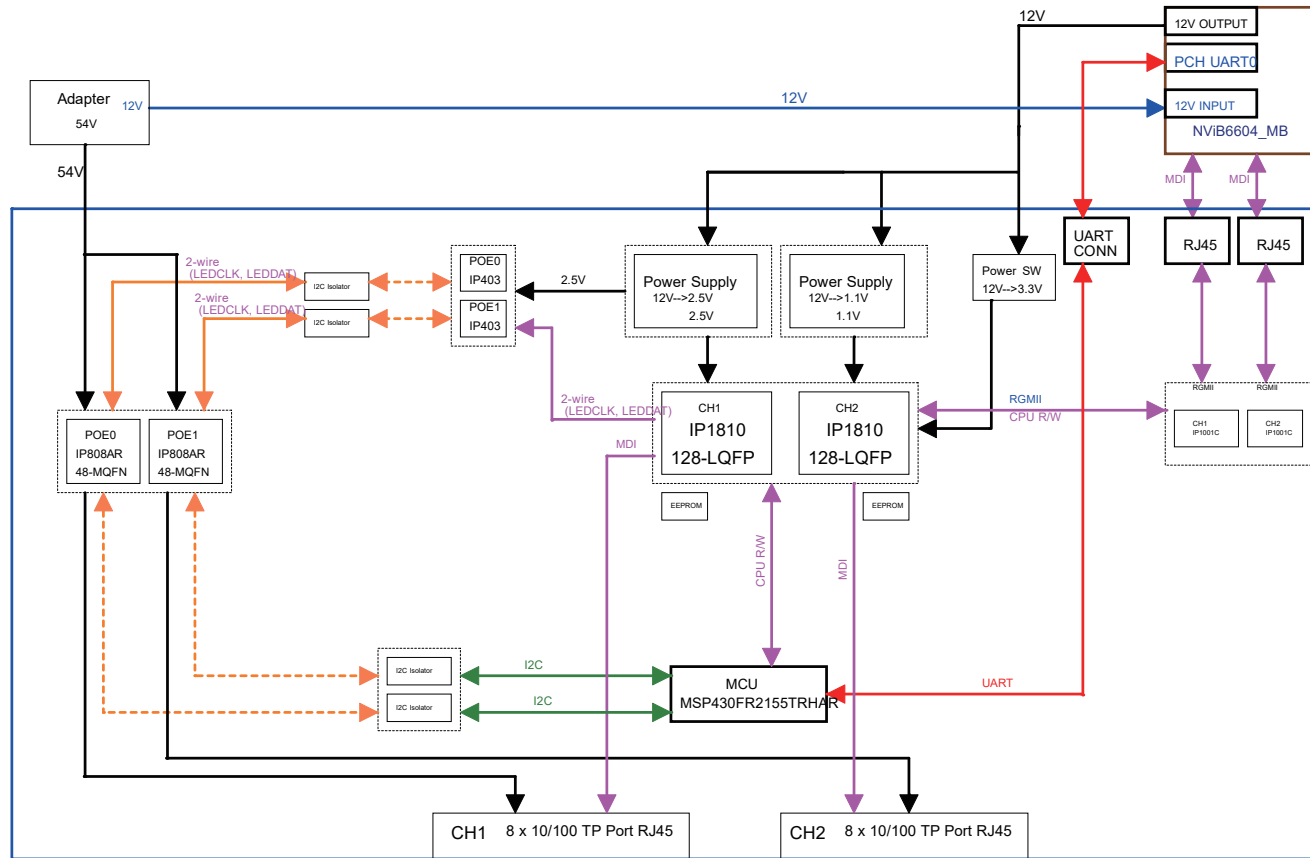

CHAPTER 3: SYSTEM SETUP

Removing the Chassis Cover



Prior to removing the chassis cover, make sure the unit's power is off and disconnected from the power sources to prevent electric shock or system damage.

1. Locate and loosen the 3 screws on the rear cover counterclockwise, as shown below.
2. Gently slide the top cover of the chassis outward, and then lift it up to fully open the chassis.



3. Completed.

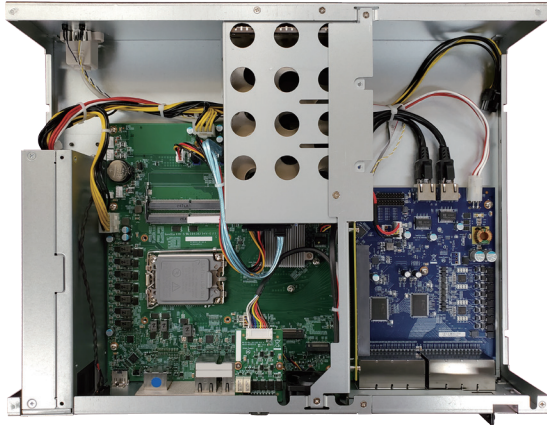

Installing SO-DIMM DDR4 Memory Modules

1. Locate the SO-DIMM sockets on the mainboard.

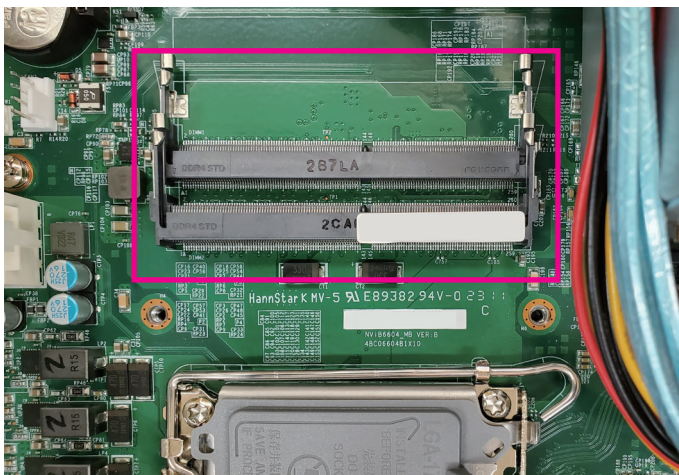

2. Insert the memory module into the socket at an approximately 30 degrees angle. The ejector tabs at the ends of the socket will automatically snap into the locked position to hold the module in place. Repeatedly follow the step above to insert the second memory module if required.

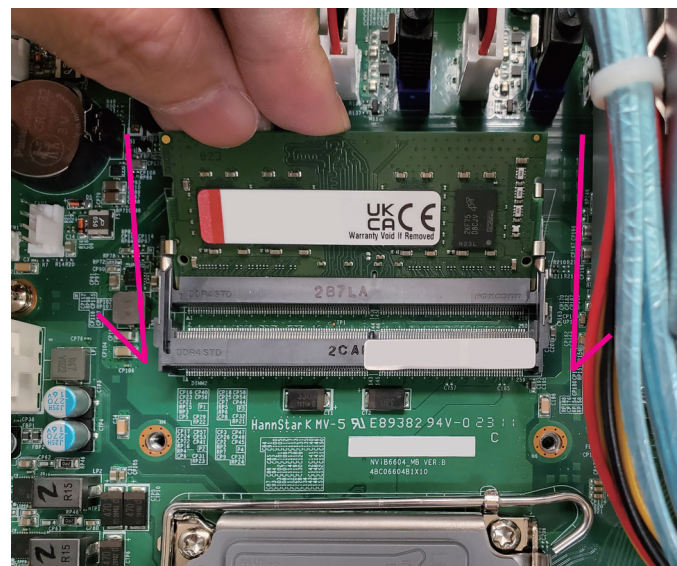

1. There is no specific installation order when inserting the memory module. Users can install the memory in either DIMM 1 or DIMM 2 according to their requirements.
2. Note that the memory sockets are designed with fool-proof measures. Do not force-plug the memory module(s) if they are not oriented correctly.

3. The assembly steps are completed.



Installing a CPU

1. Locate the CPU sockets on the mainboard.

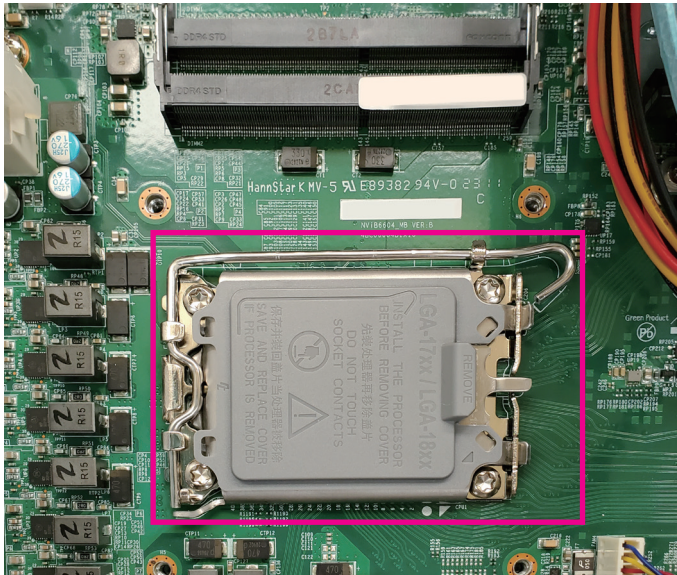

2. Release the load lever by pushing it down from the retention tab, then pull it up.

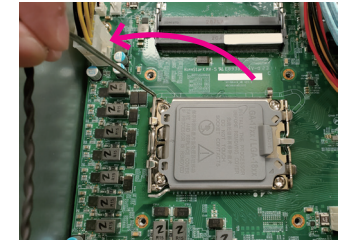
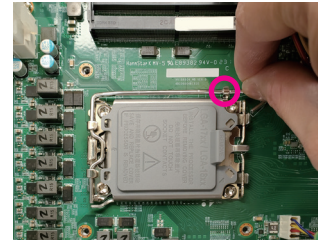

3. Lift the CPU load plate up to open the socket completely.

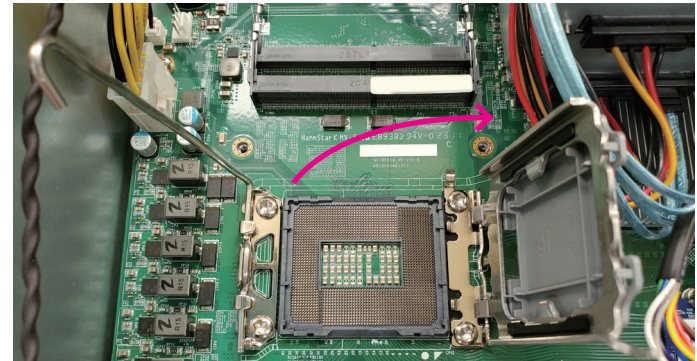

4. Insert the CPU into the CPU load bracket, ensuring that you align the triangle and notches on the CPU with the corresponding triangle marker and notches on the CPU load bracket.

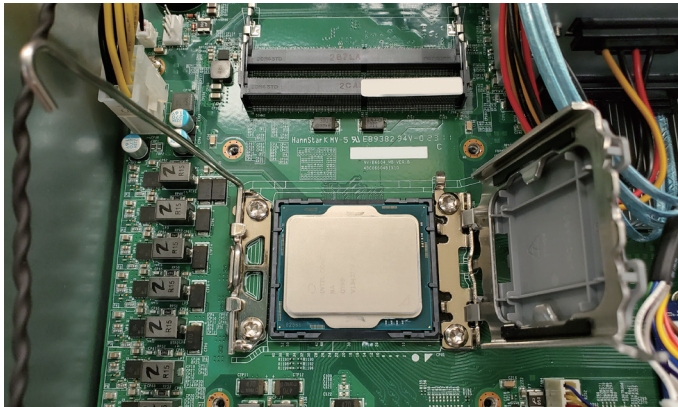

5. Slightly close the load plate and remove the plastic cover from the load plate.

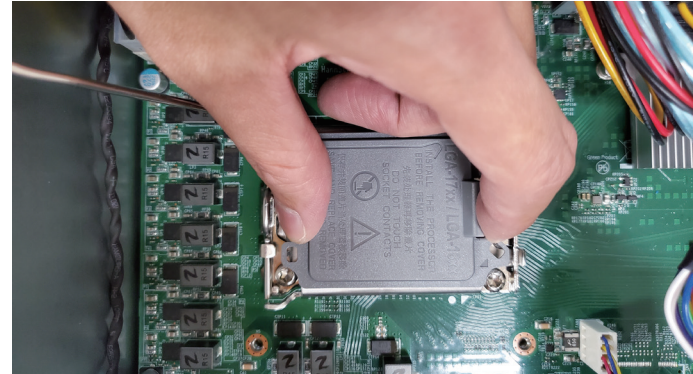

6. Gently push the load lever down until it locks under the retention tab.



7. Apply an appropriate quantity of thermal grease to the CPU and take note of the mounting holes around the CPU socket.

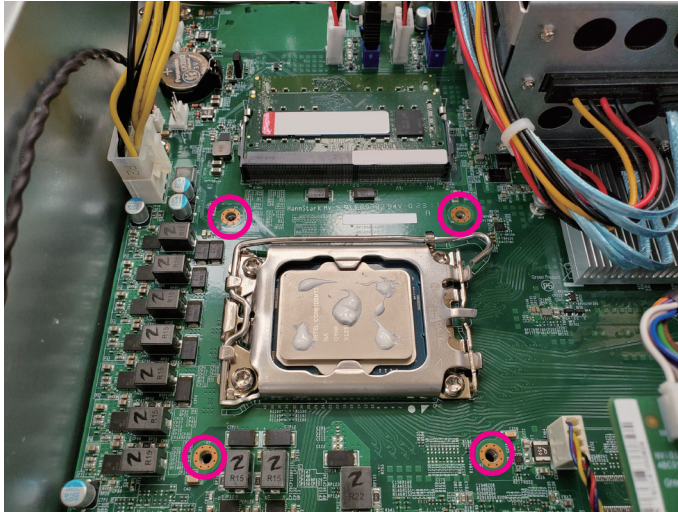

8. Place the heatsink module in position, aligning it with the mounting holes mentioned in the previous step on the mainboard. Tighten the screws following the order marked in the image below.

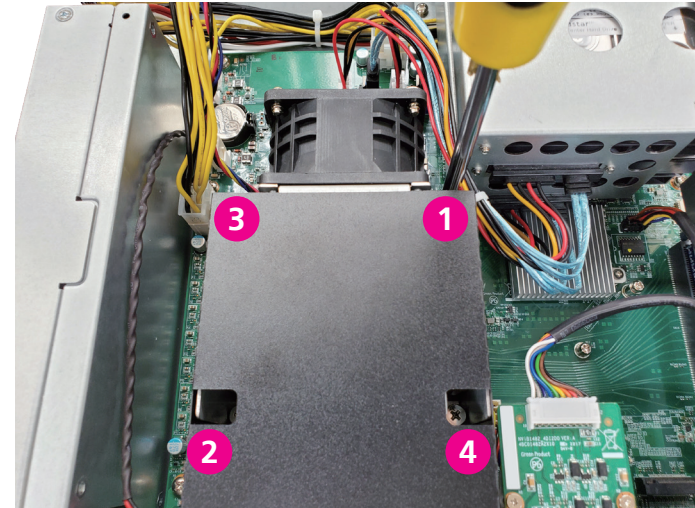

9. Plug the heatsink module power connector into CPU fan header ([FAN3](#)) on the motherboard.

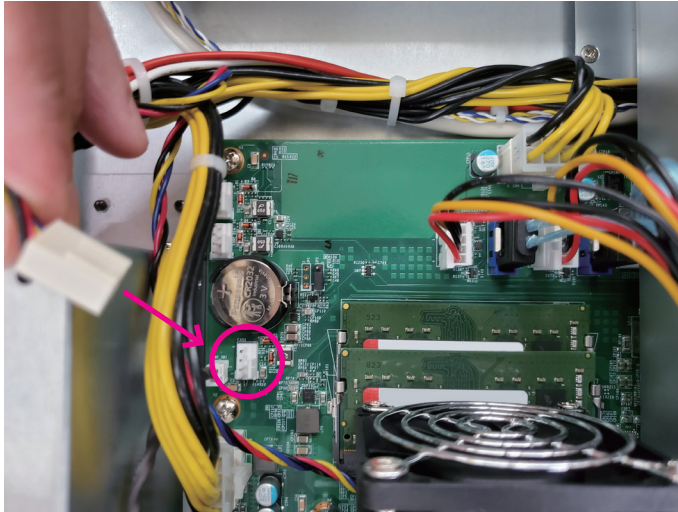

10. After connecting the power, use cable ties to organize the cables.

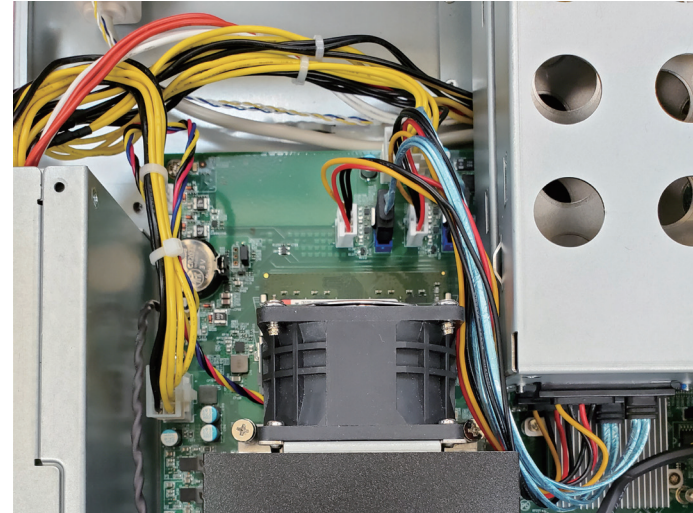

Installing an M.2 Module (Key M 2280)

1. Loosen the screw on the mainboard and set it aside for later use.

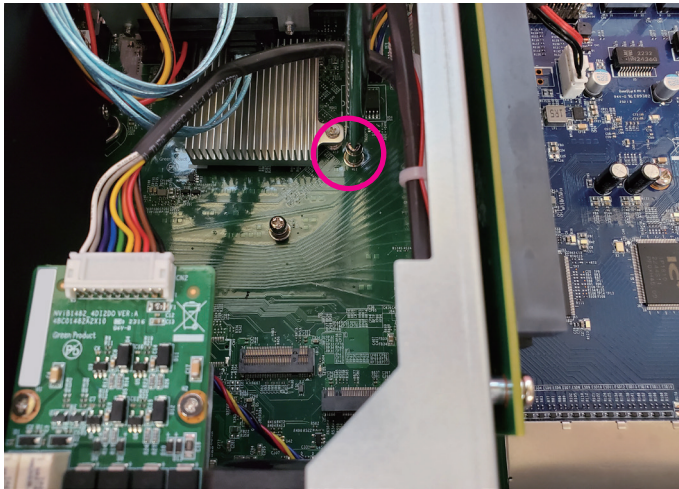

2. Insert the M.2 module into the M.2 Key M slot at a 45-degree angle until the gold-plated connector on the edge of the module completely disappears into the slot.

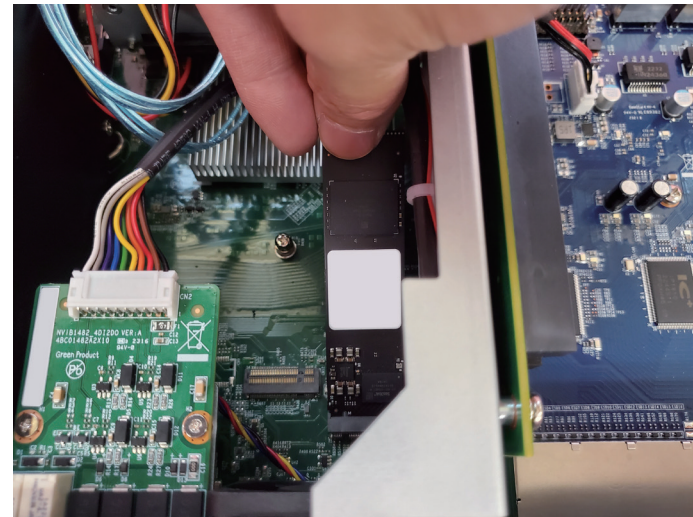

3. Push the M.2 module down and secure it with the screw that was removed from step 1.

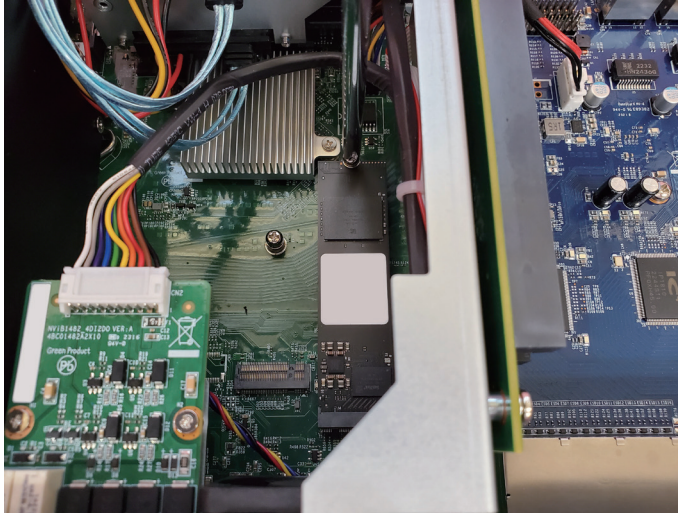

Installing an M.2 Module (Key B 2242)

1. Loosen the screw on the mainboard and set it aside for later use.

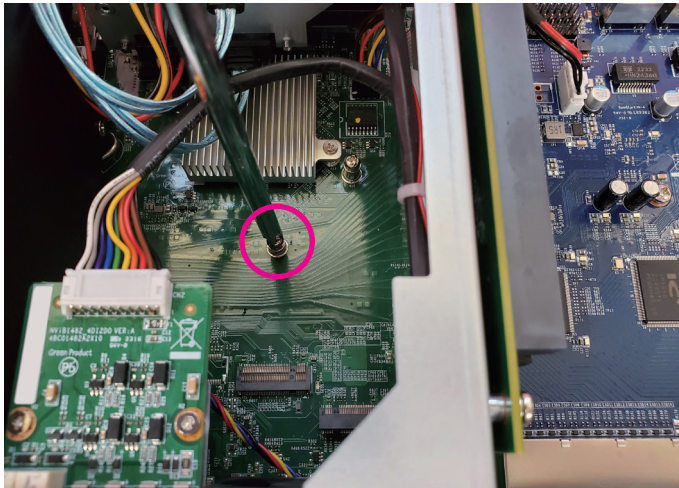

2. Insert the M.2 module into the M.2 Key B slot at a 45-degree angle until the gold-plated connector on the edge of the module completely disappears into the slot.

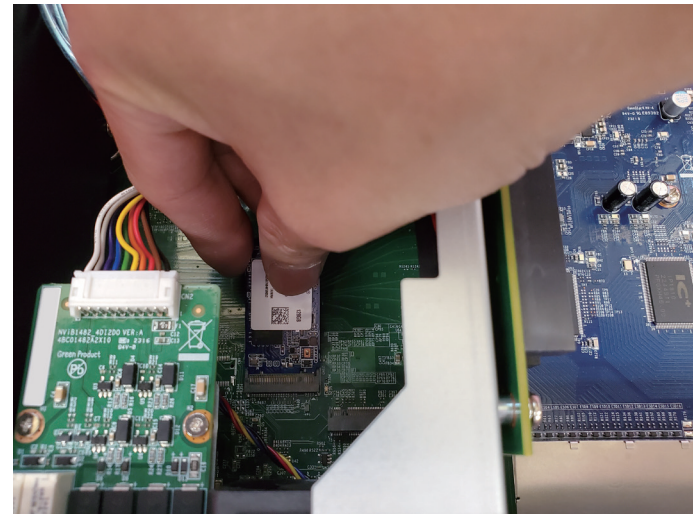

3. Push the M.2 module down and secure it with the screw that was removed from step 1.

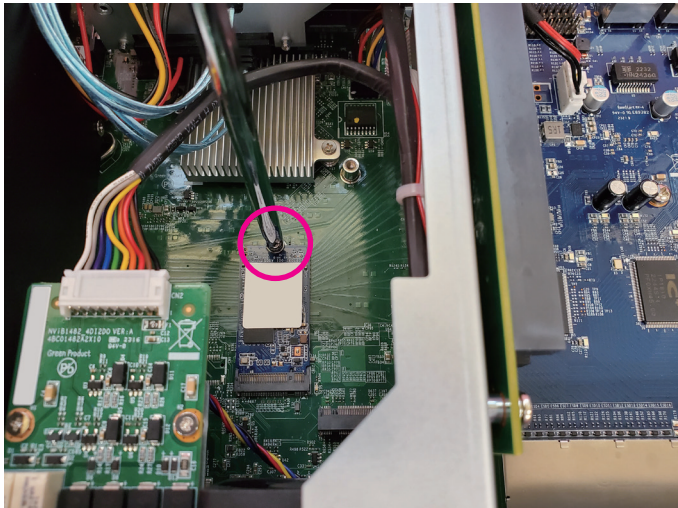

Installing 3.5" Storage Device(s)

1. Push the HDD tray latch (1) to the right to release the tray cover (2).
2. Retrieve the HDD tray from the chassis.

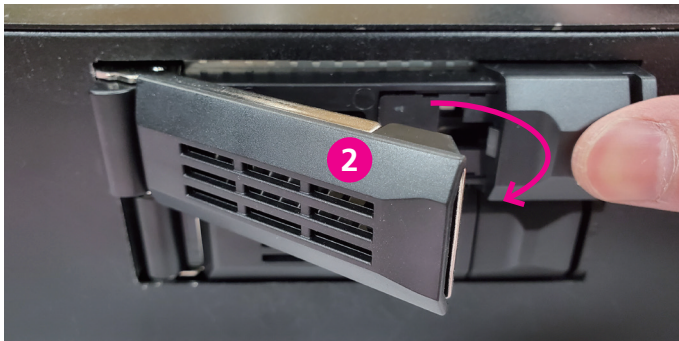

- Securely mount the 3.5" HDD within the bracket using four F#6-32 screws.

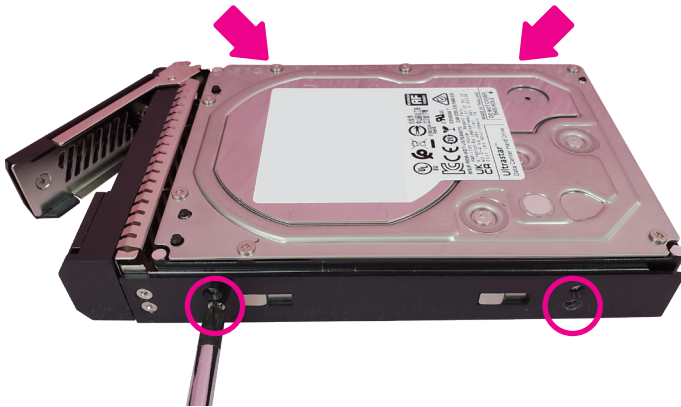

- Insert the assembled HDD tray back into the chassis (1) and then push the cover to lock it (2).

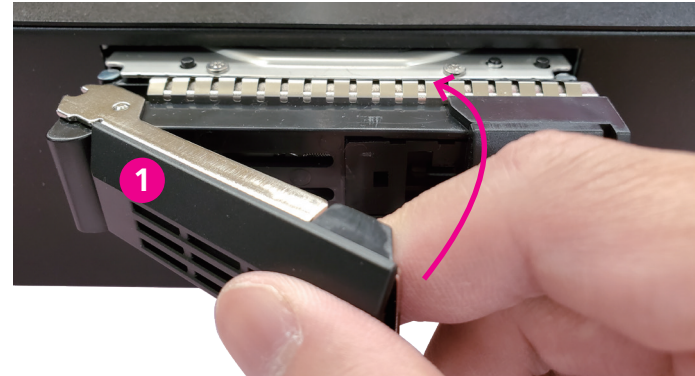

- Repeat the steps above to assemble the second HDD if necessary.

Installing a Graphic Card



To ensure proper fit before installing your graphics card, check the dimensions illustrated below.

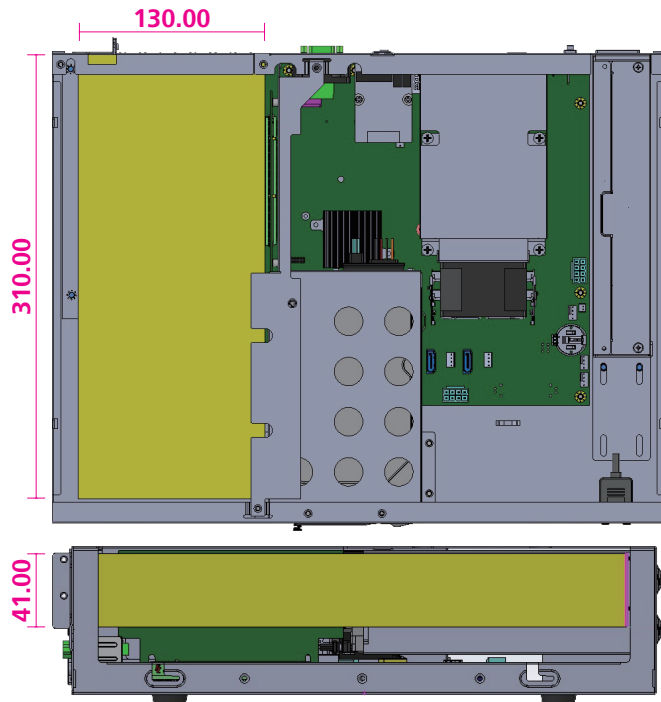

1. Loosen the screw on the mainboard and set it aside for later use.

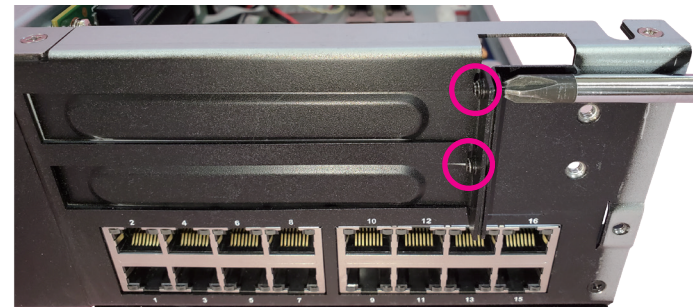
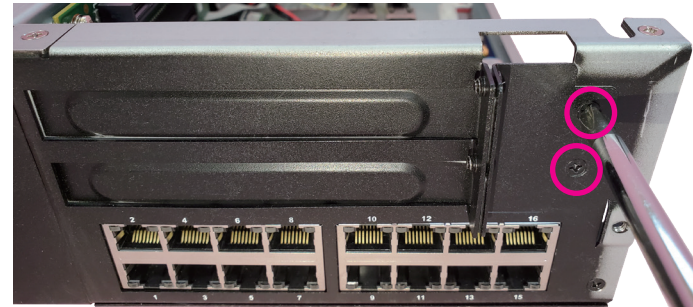

2. Remove the PCIe Brackets (1, 2).

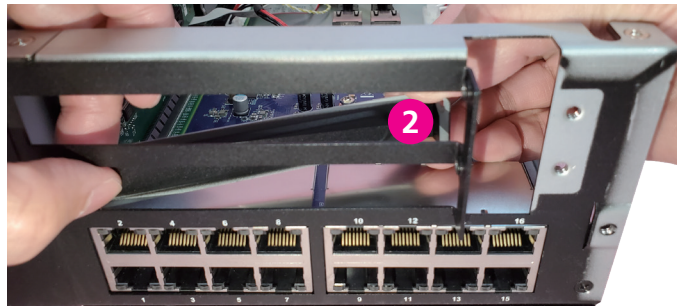

3. Carefully align the golden contacts on the graphics card with the PCIe slot and gently push it in until it securely clicks into place.

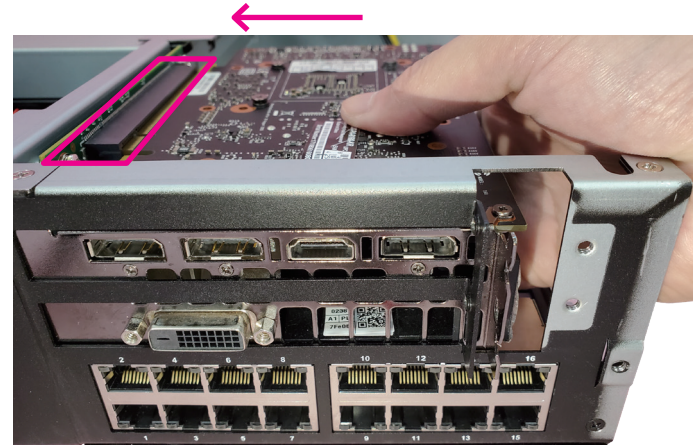

4. Reattach the PCIe bracket back onto the chassis.



5. Using the screws you set aside in step 1 to firmly secure both the brackets and the graphics card in place.

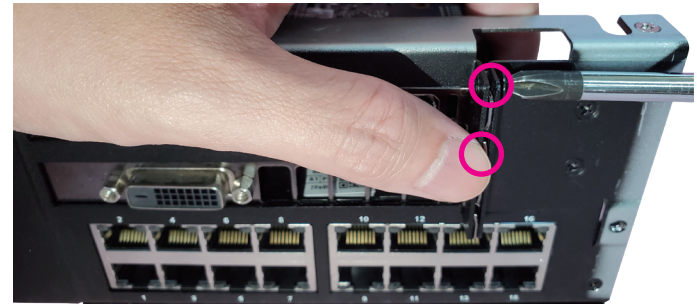
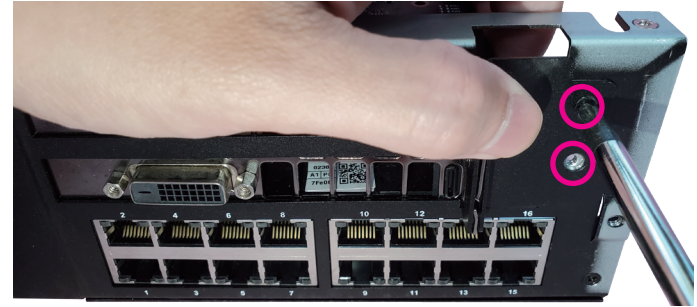

6. Connect the power connector to the graphics card. Please be aware of the power plug's orientation; it features a fool-proof design, so avoid forcing the connection if it's in the wrong direction.



If you are installing a long graphics card, it is recommended to install a GPU support bracket (not included, see the reference image below).

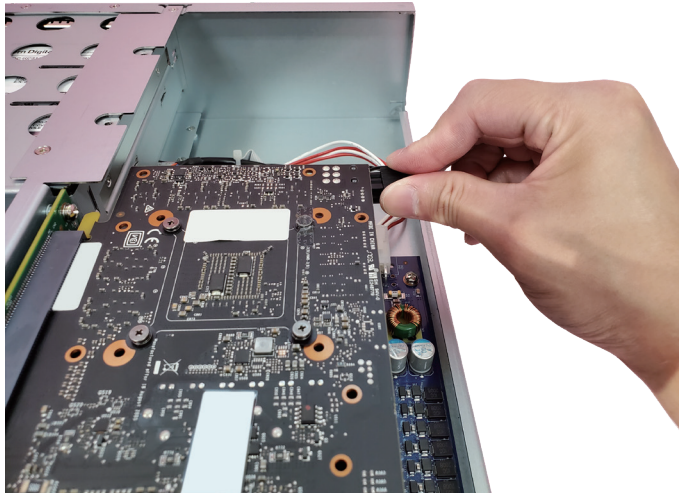

Reassembling the Chassis

1. Install the top cover back to its original position.



2. Push the chassis top cover forward until it fits snugly with the chassis.



3. Secure the screws back to their original positions.

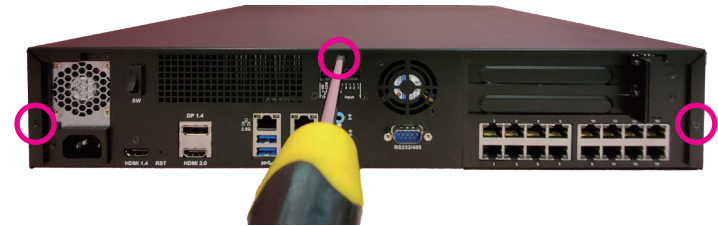

CHAPTER 4: BIOS SETUP

This chapter describes how to use the BIOS setup program for the NViS 66xxx series. The BIOS screens provided in this chapter are for reference only and may change if the BIOS is updated in the future.

To check for the latest updates and revisions, visit the NEXCOM website at www.nexcom.com.tw.

About BIOS Setup

The BIOS (Basic Input and Output System) Setup program is a menu driven utility that enables you to make changes to the system configuration and tailor your system to suit your individual work needs. It is a ROM-based configuration utility that displays the system's configuration status and provides you with a tool to set system parameters.

These parameters are stored in non-volatile battery-backed-up CMOS RAM that saves this information even when the power is turned off. When the system is turned back on, the system is configured with the values found in CMOS.

With easy-to-use pull down menus, you can configure such items as:

- Hard drives, diskette drives, and peripherals
- Video display type and display options
- Password protection from unauthorized use
- Power management features

The settings made in the setup program affect how the computer performs. It is important, therefore, first to try to understand all the setup options, and second, to make settings appropriate for the way you use the computer.

When to Configure the BIOS

- This program should be executed under the following conditions:
 - When changing the system configuration
 - When a configuration error is detected by the system and you are prompted to make changes to the setup program
 - When resetting the system clock
 - When redefining the communication ports to prevent any conflicts
 - When making changes to the Power Management configuration
 - When changing the password or making other changes to the security setup

Normally, CMOS setup is needed when the system hardware is not consistent with the information contained in the CMOS RAM, whenever the CMOS RAM has lost power, or the system features need to be changed.

Default Configuration

Most of the configuration settings are either predefined according to the Load Optimal Defaults settings which are stored in the BIOS or are automatically detected and configured without requiring any actions. There are a few settings that you may need to change depending on your system configuration.

Entering Setup











When the system is powered on, the BIOS will enter the Power-On Self Test (POST) routines. These routines perform various diagnostic checks; if an error is encountered, the error will be reported in one of two different ways:

- If the error occurs before the display device is initialized, a series of beeps will be transmitted.
- If the error occurs after the display device is initialized, the screen will display the error message.

Powering on the computer and immediately pressing allows you to enter Setup.

Press the  key to enter Setup:

Legends

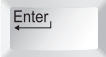
Key	Function
	Moves the highlight left or right to select a menu.
	Moves the highlight up or down between sub-menus or fields.
	Exits the BIOS Setup Utility.
	Scrolls forward through the values or options of the highlighted field.
	Scrolls backward through the values or options of the highlighted field.
	Selects a field.
	Displays General Help.
	Load previous values.
	Load optimized default values.
	Saves and exits the Setup program.
	Press <Enter> to enter the highlighted sub-menu

Scroll Bar

When a scroll bar appears to the right of the setup screen, it indicates that there are more available fields not shown on the screen. Use the up and down arrow keys to scroll through all the available fields.

Submenu

When “▶” appears on the left of a particular field, it indicates that a submenu which contains additional options are available for that field. To display the submenu, move the highlight to that field and press  .

BIOS Setup Utility

Once you enter the AMI BIOS Setup Utility, the Main Menu will appear on the screen. The main menu allows you to select from several setup functions and one exit. Use arrow keys to select among the items and press  to accept or enter the submenu.

Main

The Main menu is the first screen that you will see when you enter the BIOS Setup Utility.

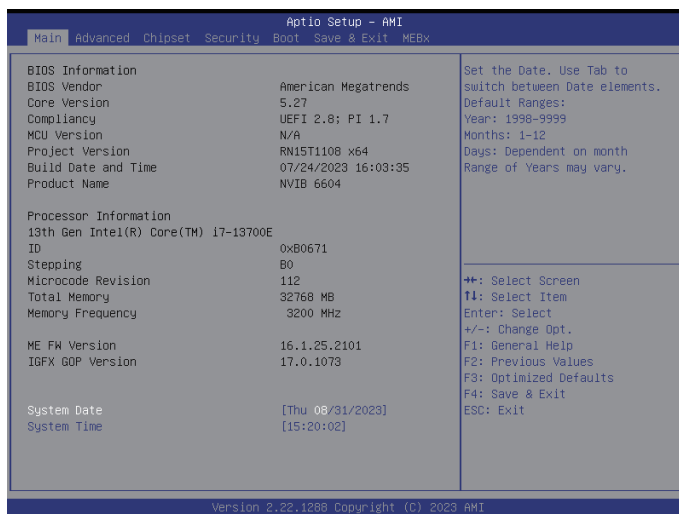

System Date

The date format is <day>, <month>, <date>, <year>. Day displays a day, from Monday to Sunday. Month displays the month, from January to December. Date displays the date, from 1 to 31. Year displays the year, from 1999 to 2099.

System Time

The time format is <hour>, <minute>, <second>. The time is based on the 24-hour military-time clock. For example, 1 p.m. is 13:00:00. Hour displays hours from 00 to 23. Minute displays minutes from 00 to 59. Second displays seconds from 00 to 59.

Advanced

The Advanced menu allows you to configure your system for basic operation. Some entries are defaults required by the system board, while others, if enabled, will improve the performance of your system or let you set some features according to your preference.



Setting incorrect field values may cause the system to malfunction.

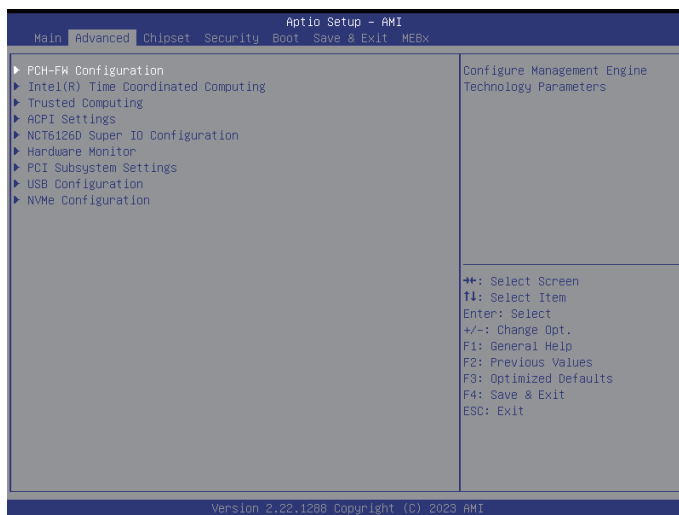

PCH-FW Configuration

This section is used to view CPU status and configure CPU parameters.

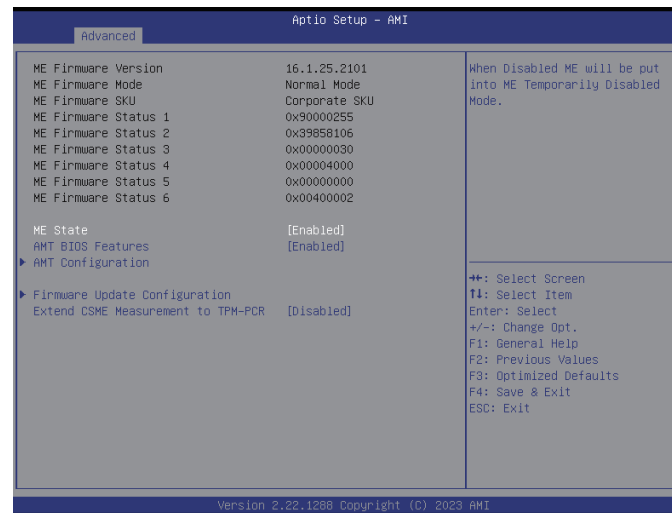

ME State

When disabled ME will be put into ME Temporarily Disabled Mode.

AMT BIOS Features

Enable or disable AMT BIOS Features.

AMT Configuration

Enter the AMT Configuration sub-menu.

Firmware Update Configuration

Enter the Firmware Update Configuration sub-menu.

Extend CSME Measurement to TPM-PCR

Enable or disable Extend CSME Measurement to TPM-PCR.

AMT Configuration

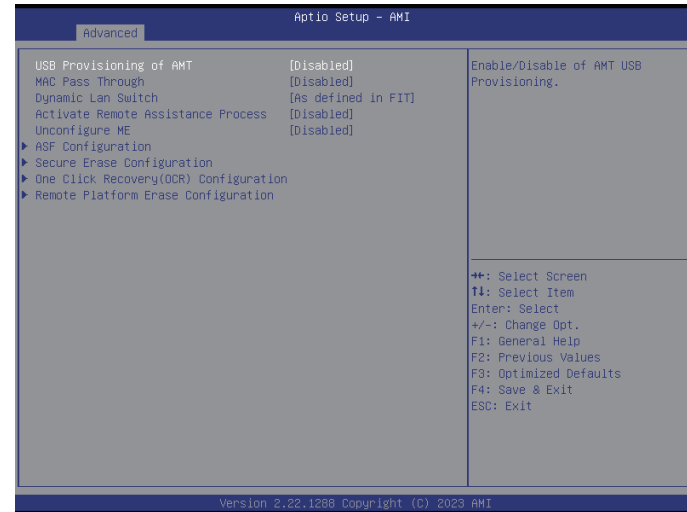

USB Provisioning of AMT

Enable or disable USB Provisioning of AMT.

MAC Pass Through

Enable or disable MAC Pass Through.

Dynamic Lan Switch

Configure AMT support from Integrated LAN to Discrete LAN.

Activate Remote Assistance Process

Enable or disable Activate Remote Assistance Process.

Unconfigure ME

Enable or disable unconfigure ME.

ASF Configuration

Enter the ASF Configuration sub-menu.

Secure Erase Configuration

Enter the Secure Erase Configuration sub-menu.

One Click Recovery(OCR) Configuration

Enter the One Click Recovery(OCR) Configuration sub-menu.

Remove Platform Erase Configuration

Enter the Remove Platform Erase Configuration.

AMT Configuration > ASF Configuration

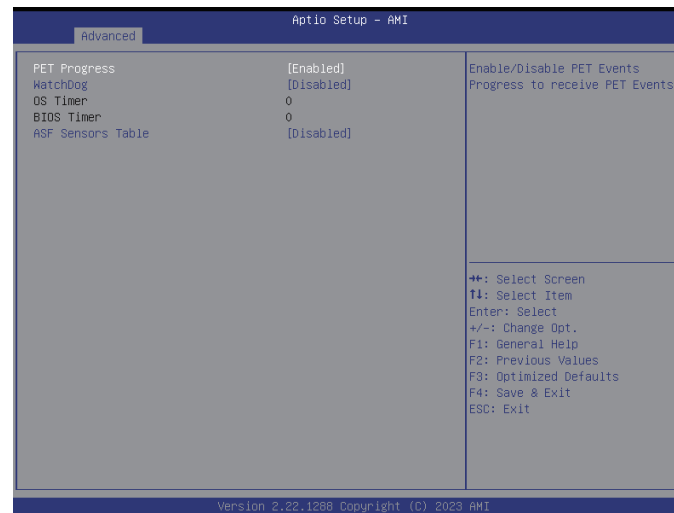

PET Progress

Enable or disable PER events progress to receiver PET Events.

WatchDog

Enable or disable watchdog.

ASF Sensors Table

Enable or disable ASF Sensors Table.

AMT Configuration > Secure Erase Configuration



Secure Erase mode

Configure the Secure Erase module behavior.

Simulated: Performs SE flow without erasing SSD.

Real: Erases SSD.

Force Secure Erase

Enable or disable the option to Force Secure Erase on next boot.

AMT Configuration > One Click Recovery(OCR) Configuration



OCR Httos Boot

Enable or disable OCR Httos Boot.

OCR PBA Boot

Enable or disable OCR PBA Boot.

OCR Windows Recovery Boot

Enable or disable OCR Windows Recovery Boot.

OCR Disable Secure Boot

Enable or disable OCR Disable Secure Boot.

AMT Configuration > Remove Platform Erase Configuration



Enable Remove Platform Erase Feature

Enable Remove Platform Erase Feature.

SSD Erase Mode

Configure the SSD Erase Mode.

Firmware Update Configuration

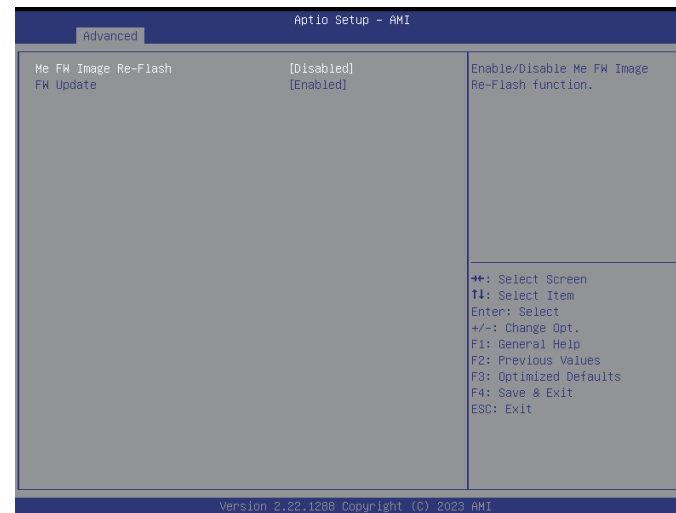

ME FW Image Re-Flash

Enable or disable ME FW Image Re-Flash function.

FW Update

Enable or disable FW Update

Intel(R) Time Coordinated Computing



C states

Enter the C states sub-menu.

Hyper-Threading

Enter the Hyper-Threading sub-menu.

C States



Boot performance mode

Configure the performance mode of the CPU.

Intel(R) SpeedStep(tm)

Enable or disable Intel SpeedStep technology.

Turbo Mode

Enable or disable turbo mode.

C states

Enable or disable CPU Power Management. Allows CPU to go to C states when it's not 100% utilized.

Hyper-Threading



Active Efficient-cores

Select the quantity of efficient cores to enable in each processor package.

Hyper-Threading

Enable or disable Hyper-Threading Technology.

Efficient-core Information

Enter the Efficient-core Information sub-menu.

Intel (VMX) Virtualization Technology

When this field is set to Enabled, the VMM can utilize the additional hardware capabilities provided by Vanderpool Technology.

Active Performance-cores

Select the quantity of performance cores to enable in each processor package.

Hyper-Threading > Efficient-core Information

Display the information of the efficient-core.

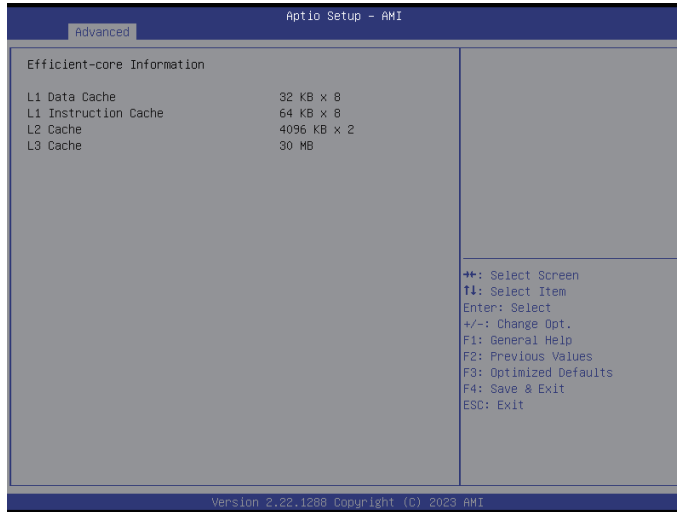

Trusted Computing

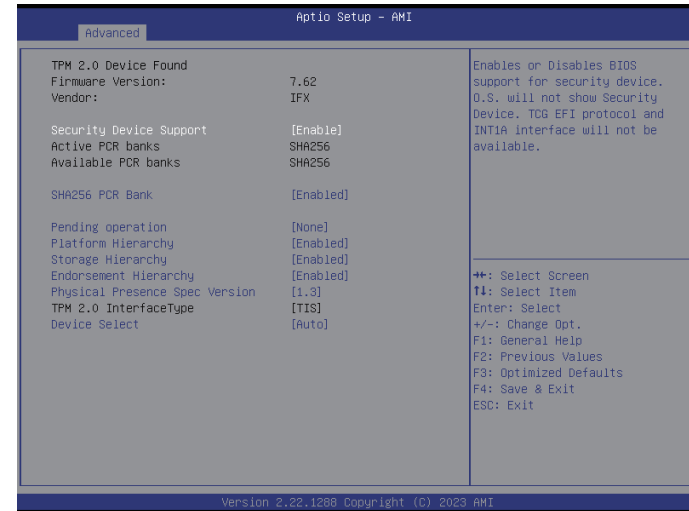

Security Device Support

Enable or disable BIOS support for security device. O.S. will not show Security Device. TCG EFI protocol and INT1A interface will not be available.

SHA256 PCR Bank

Enable or disable SHA256 PCR Bank.

Pending operation

Schedule an operation for the security device.

Platform Hierarchy

Enable or disable platform hierarchy.

Storage Hierarchy

Enable or disable storage hierarchy.

Endorsement Hierarchy

Enable or disable endorsement hierarchy.

Physical Presence Spec Version

Configure the physical presence spec version.

Device Select

TPM 1.2 will restrict support to TPM 1.2 devices. TPM 2.0 will restrict support to TPM 2.0 devices. Auto will support both TPM 1.2 and 2.0 devices with the default set to TPM 2.0 devices if not found, and TPM 1.2 devices will be enumerated.

ACPI Settings



Enable Hibernation

Enable or disable system ability to hibernation (OS/S4 Sleep State). This option may not be effective with some operating systems.

ACPI Sleep State

Select the highest ACPI sleep state the system will enter when the suspend button is pressed.

NCT6126D Super IO Configuration

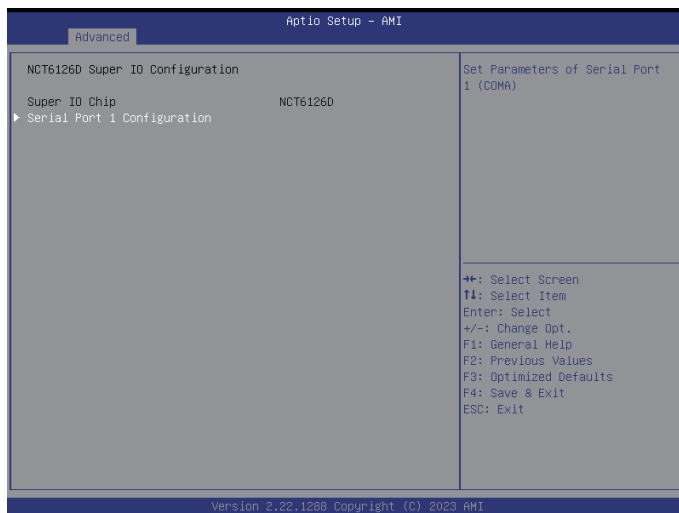

Enable Hibernation

Enter the Serial Port 1 Configuration sub-menu.

Serial Port 1 Configuration

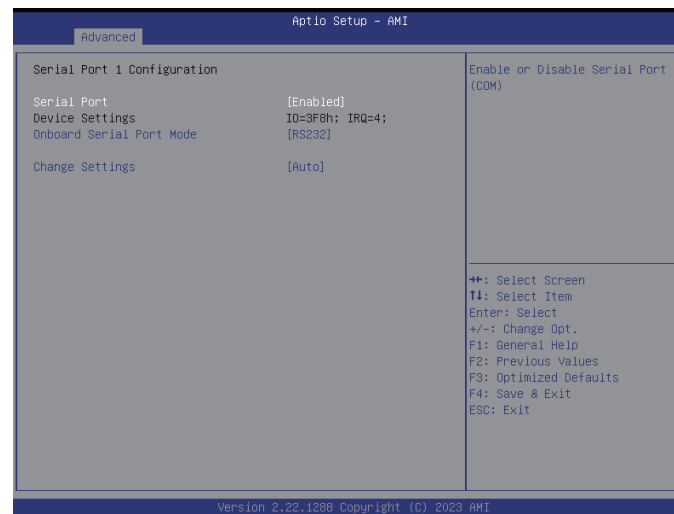

Serial Port

Enable or disable serial port (COM).

Onboard Serial Port Mode

Configure the serial port mode to RS232 or RS485 Auto.

Changes Settings

Select an optimal setting for the Super IO device.

Hardware Monitor

This section is used to monitor hardware such as temperature, fan speed, and voltages.

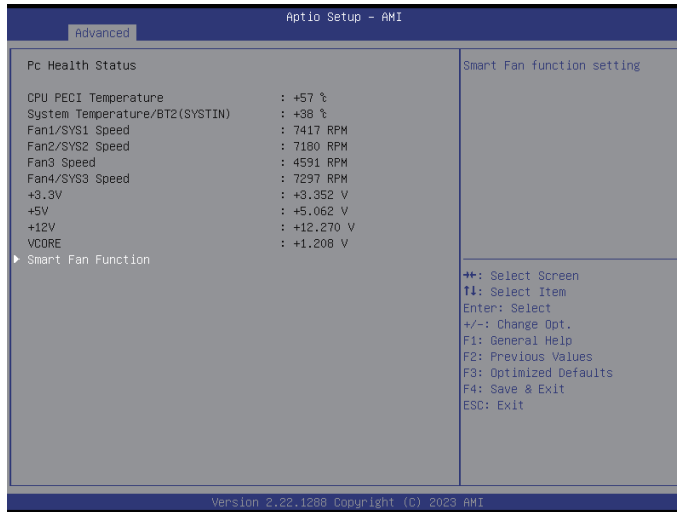

Smart Fan Function

Enter the Smart Fan Function sub-menu.

Smart Fan Function



Fan1/2/3/4 Setting

Enter the Fan1/2/3/4 Setting sub-menu.

Smart Fan Function > Fan1/2/3/4 Setting

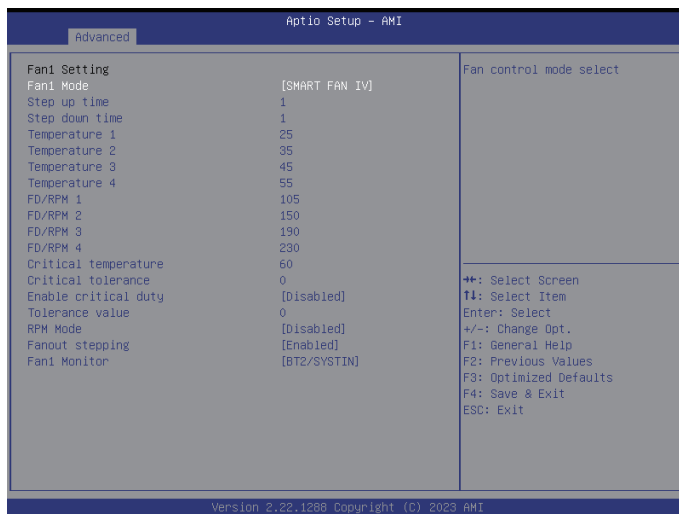

Fan1/2/3/4 Mode

Configure the fan mode.

Step up time

The amount of time fan takes to increase its value by one step.

Step down time

The amount of time fan takes to decrease its value by one step.

Temperature 1/2/3/4 (Fan1/2/3/4)

Configure the temperature setting.

FD/RPM 1/2/3/4 (Fan1/2/3/4)

The value of Fan Duty/RPM when temperature is T1 to T4.

Critical temperature (Fan1/2/3/4)

Configure the time that fan out requires for reducing its value by one step.

Critical tolerance (Fan1/2/3/4)

Configure the tolerance of critical temperature.

Enable critical duty (Fan1/2/3/4)

Enables critical duty, if enabled, it will use critical duty value for fan out. If not will use full speed for fan out.

RPM Mode (Fan1/2/3/4)

Enable or disable Smart Fan IV close loop fan control RPM Mode.

Fanout stepping (Fan1/2/3)

Enable or disable Smart Fan IV stepping.

Fan1/2/3/4 Monitor (Fan1/2/3/4)

Select a mode for fan monitor.

PCI Subsystem Settings

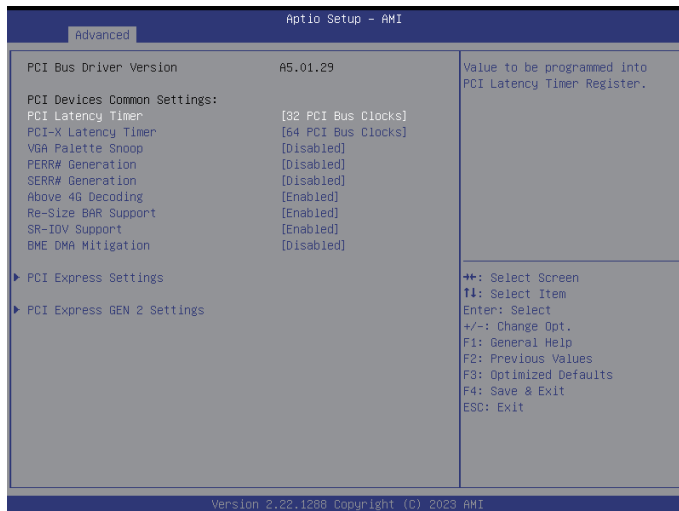

PCI Latency Timer

Value to be programmed into PCI Latency Timer Register.

PCI-X Latency Timer

Value to be programmed into PCI-X Latency Timer Register.

VGA Palette Snoop

Enable or disable the VGA palette registers snooping.

PERR# Generation

Enable or disable the PCI device to generate PERR#.

SERR# Generation

Enable or disable the PCI device to generate SERR#.

Above 4G Decoding

Enable or disable decoding of 64-bit devices in 4G address space.

Re-Size BAR Support

Enable or disable Re-Size BAR support.

SR-IOV Support

Enable or disable SR-IOV support.

BME DMA Mitigation

Enable or disable BME DMA Mitigation support.

PCI Express Settings

Enter the PCI Express Settings sub-menu.

PCI Express Gen 2 Settings

Enter the PCI Express Gen 2 Settings sub-menu.

PCI Express Settings

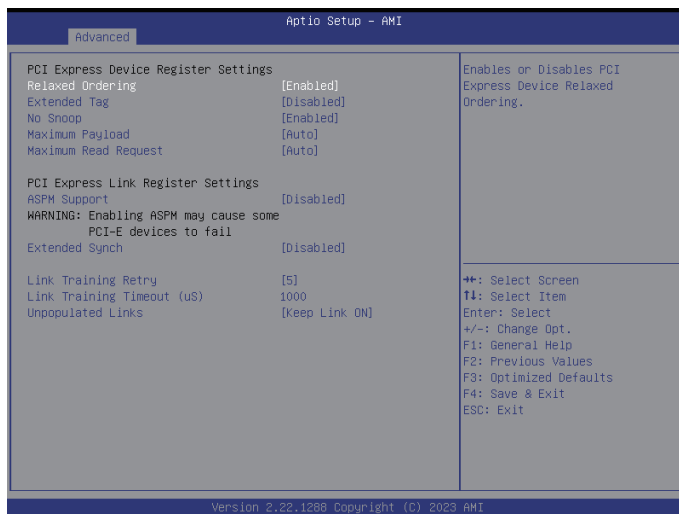

Relaxed Ordering

Enable or disable PCI Express Device Relaxed Ordering.

Extended Tag

Enable or disable Extended Tag.

No Snoop

Enable or disable No Snoop.

Maximum Payload

Select the maximum TLP payload size of the PCI Express devices.

Maximum Read Request

Select the maximum read request size of the PCI Express devices.

ASPM Support

Select the ASPM level.

Force L0 Forces all links to L0 state.

Auto The BIOS automatically selects an ASPM level.

Disable Disables ASPM.

Extended Synch

When this function is enabled, it allows generation of extended synchronization patterns.

Link Training Retry

Select the number of retry attempts.

Link Training Timeout (US)

Select the timeout period of link training in microseconds.

Unpopulated Links

Enable or disable unpopulated PCI Express links.

PCI Express Gen 2 Settings

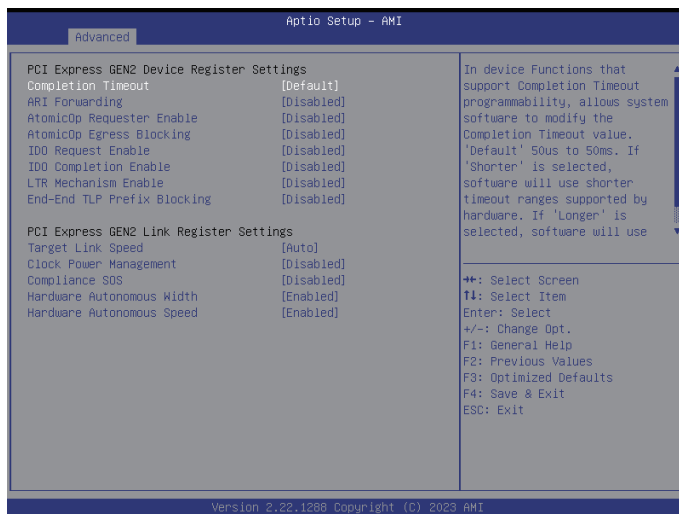

Completion Timeout

In device functions that support Completion Timeout programmability, allows system software to modify the Completion Timeout value.

ARI Forwarding

Enable or disable ARI Forwarding.

AtomicOp Requester Enable

Enable or disable AtomicOp Requester Enable.

AtomicOp Egress Blocking

Enable or disable AtomicOp Egress Blocking.

IDO Request Enable

Enable or disable IDO Request Enable.

IDO Completion Enable

Enable or disable IDO Completion Enable.

LTR Mechanism Enable

Enable or disable LTR Mechanism Enable.

End-End TLP Prefix Blocking

Enable or disable End-End TLP Prefix Blocking.

Target Link Speed

Configure the PCIe link speed.

Clock Power Management

Enable or disable Clock Power Management.

Compliance SOS

Enable or disable Compliance SOS.

Hardware Autonomous Width

Enable or disable Hardware Autonomous Width.

Hardware Autonomous Speed

Enable or disable Hardware Autonomous Speed.

USB Configuration



Legacy USB Support

Enabled Enable legacy USB.

Auto Disable support for legacy when no USB devices are connected.

Disabled Keep USB devices available only for EFI applications.

XHCI Hand-off

This is a workaround for OSs that does not support XHCI hand-off. The XHCI ownership change should be claimed by the XHCI driver.

USB Mass Storage Driver Support

Enable or disable USB mass storage driver support.

USB transfer time-out

The time-out value for control, bulk, and Interrupt transfers.

Device reset time-out

Selects the USB mass storage device's start unit command timeout.

Device power-up delay

Maximum time the value will take before it properly reports itself to the Host Controller. "Auto" uses default value: for a Root port it is 100 ms, for a Hub port the delay is taken from Hub descriptor.

Mass Storage Devices

Configure the mass storage device emulation type. AUTO enumerates devices according to their media format. Optical drives are emulated as CDROM, drives with no media will be emulated according to a drive type.

NVMe Configuration

This section is used to display information on the NVMe devices installed. Click on the installed device for more detailed configuration.



Self Test Option

Configure the method used for self test.

Short: Short option will take couple of minutes to complete.

Extended: Extended option will take several minutes to complete.

Self Test Action

Configure the items used for self test. Controller Only Test and Controller and NameSpace Test options are available. Selecting Controller and NameSpace Test will take longer to complete.

Chipset

This section gives you functions to configure the system based on the specific features of the chipset. The chipset manages bus speeds and access to system memory resources.



System Agent (SA) Configuration

Enter the System Agent (SA) Configuration sub-menu.

PCH-IO Configuration

Enter the PCH-IO Configuration sub-menu.

System Agent (SA) Configuration

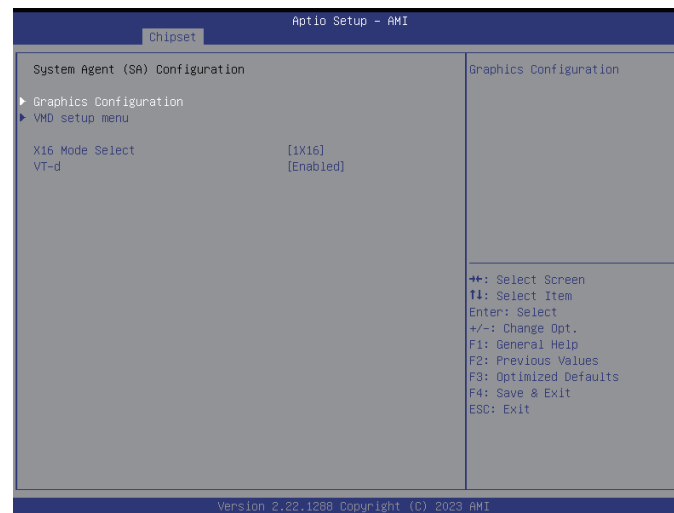

Graphics Configuration

Enter the Graphics Configuration sub-menu.

VMD setup menu

Enter the VMD setup menu sub-menu.

X16 Mode Select

Select a PCIe mode.

VT-d

Enable or disable Intel® VT-d technology.

Graphics Configuration



DVMT Pre-Allocated

Select DVMT 5.0 Pre-Allocated (Fixed) Graphics Memory size used by the Internal Graphics Device.

VMD setup menu



Enable VMD controller

Enable or disable to VMD controller.

PCH-IO Configuration

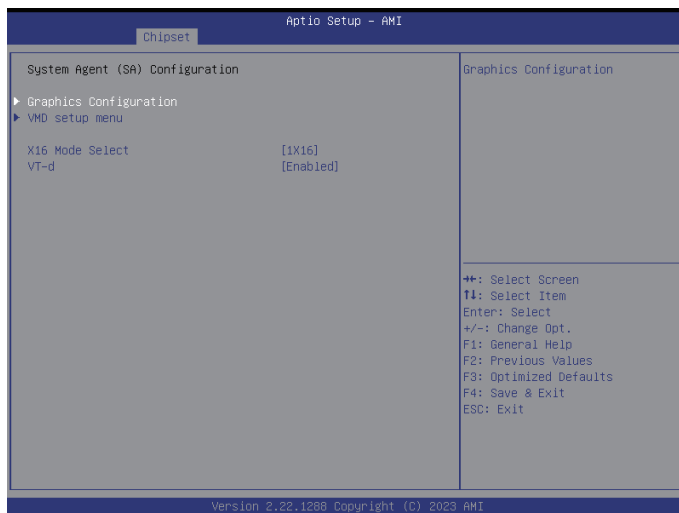

SATA Configuration

Enter the SATA Configuration sub-menu.

State After G3

Configure the power state when power is re-applied after a power failure (G3 state).

SATA Configuration

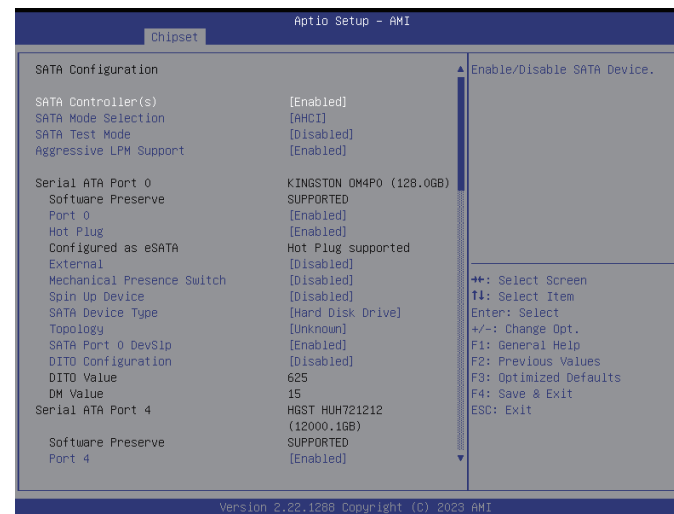

SATA Controller(s)

Enable or disable the SATA controller.

SATA Mode Selection

Configure the SATA mode.

AHCI: This option configures the Serial ATA drives to use AHCI (Advanced Host Controller Interface). AHCI allows the storage driver to enable the advanced Serial ATA features which will increase storage performance.

SATA Test Mode

Enable or disable SATA test mode.

Aggressive LPM Support

Enable or disable Aggressive LPM Support.

Serial ATA Port 0~4

Port

Enable or disable SATA port.

Hot Plug

Enable or disable hot plugging feature.

External

Enable or disable the external SATA option.

Mechanical Presence Switch

Enable or disable reporting of whether port 0 has a mechanical presence switch. **Note:** Requires hardware support.

Spin Up Device

Enable or disable staggered spin up on devices connected to SATA.

SATA Device Type

Identify what type of SATA device is connected.

Topology

Identify what type of SATA connection is used.

SATA Port 0 DevSlp

Enable or disable SATA port 0 DevSlp. Before enabling DevSlp, board rework is needed.

DIT0 Configuration

Enable or disable DIT0 configuration for SATA port 0.

Security



Administrator Password

Select this to reconfigure the administrator's password.

Secure Boot

Enter the Secure Boot sub-menu.

TCG Storage Security Configuration

Configure the TCG storage security. The item shown here depends on the storage device you have connected.

Secure Boot



Secure Boot

Secure boot feature is active if secure boot is enabled. Platform Key (PK) is enrolled and the system is in user mode. The mode change requires platform reset.

Secure Boot Mode

Select to configure the secure boot mode.

Standard: Fixed secure boot policy.

Custom: Changeable Image Execution policy and Secure Boot key databases.

Restore Factory Keys

Enter the Restore Factory Keys sub-menu.

Key Management

Enter the Key Management sub-menu.

Restore Factory Keys

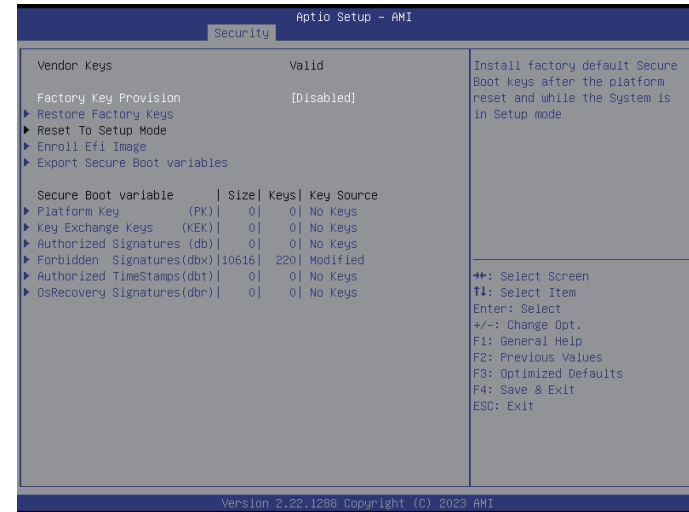

Factory Key Provision

Install factory default secure boot keys after the platform reset and while the system is in Setup mode.

Restore Factory Keys

Force system into User Mode. Install factory default Secure Boot Key databases.

Reset To Setup Mode

Delete all Secure Boot key databases from NVRAM.

Enroll Efi Image

Run the image in Secure Boot Mode.

Export Secure Boot Variables

Copy NVRAM content of Secure Boot variables to files in a root folder on a file system device.

Platform Key (PK) / Key Exchange Keys / Authorized Signatures / Forbidden Signatures / Authorized TimeStamps / OsRecovery Signatures

Enroll factory defaults or load the keys from a file.

Boot

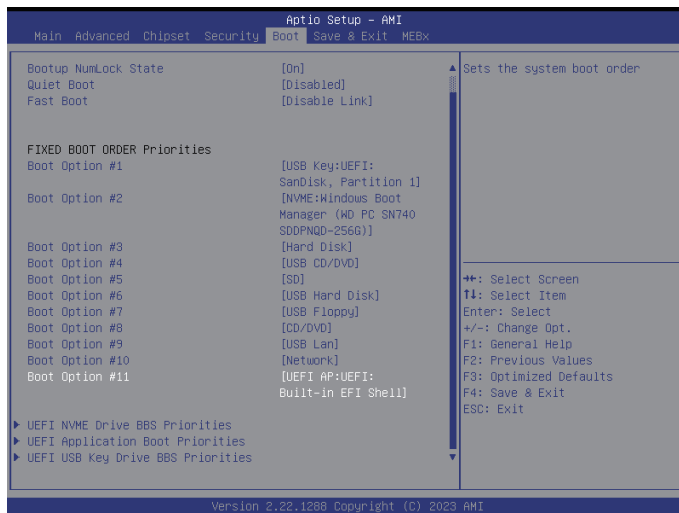

Bootup NumLock State

Set the system boot order.

Quiet Boot

Enable or disable the quiet boot function.

Fast Boot

Enable or disable boot with initialization of a minimal set of devices required to launch active boot option. This doesn't affect the BBS boot options.

FIXED BOOT ORDER PRIORITIES

Boot Option 1~11

Adjust the boot sequence of the system. Boot Option #1 is the first boot device that the system will boot from, next will be Boot Option #2 and so forth.

UEFI NVMe Drive BBS Priorities / UEFI Application Boot Priorities / UEFI USB Key Drive BBS Priorities

Configure the boot device priority sequence from available UEFI key drives.

Save & Exit

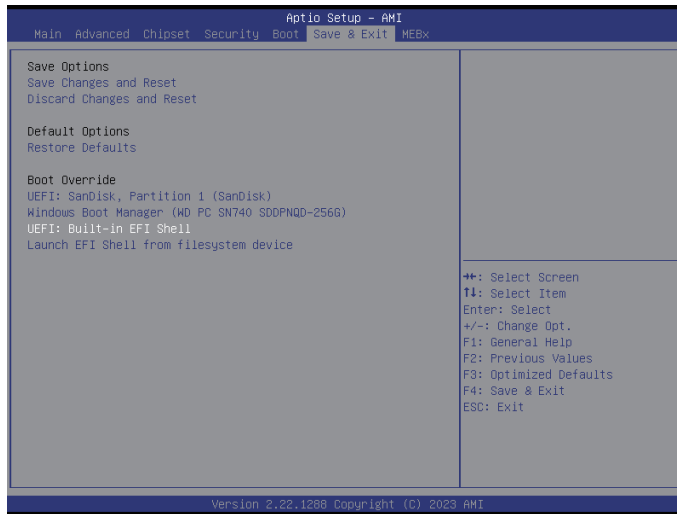

Save Changes and Reset

To save the changes and reset, select this field then press <Enter>. A dialog box will appear. Confirm by selecting Yes.

Discard Changes and Reset

To exit the Setup utility and reset without saving the changes, select this field then press <Enter>. You may be prompted to confirm again before exiting.

Restore Defaults

To restore the BIOS to default settings, select this field then press <Enter>. A dialog box will appear. Confirm by selecting Yes.

Boot Override

To bypass the boot sequence from the Boot Option List and boot from a particular device, select the desired device and press <Enter>

MEBx



Intel(R) ME Password

Press to enter the Intel(R) ME Password sub-menu. Refer to [Appendix A](#) for more detailed configurations.

APPENDIX A: NViS 66162 INTEL AMT CONFIGURATION

1. Press the <Delete> button to enter the BIOS when turning on or rebooting the system. Navigate to the MEBx tab within the BIOS menu. Press <Enter> button to access this feature. By default, the password is "admin."
2. You may change the password by going to **Change ME Password**. The password must be at least 8 characters long and include a combination of uppercase letters, lowercase letters, numbers, and symbols. For example, !QAZ1qaz

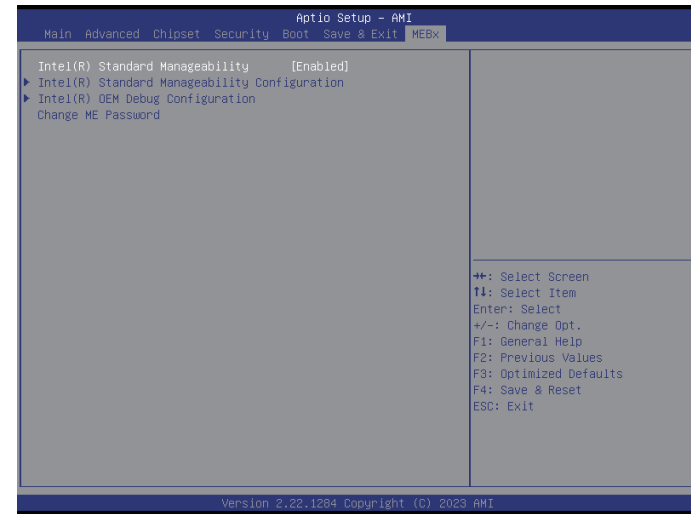

- Follow these steps to navigate the configuration items: **Intel(R) Standard Manageability Configuration > User Consent > User Opt-in**, then select **All**.

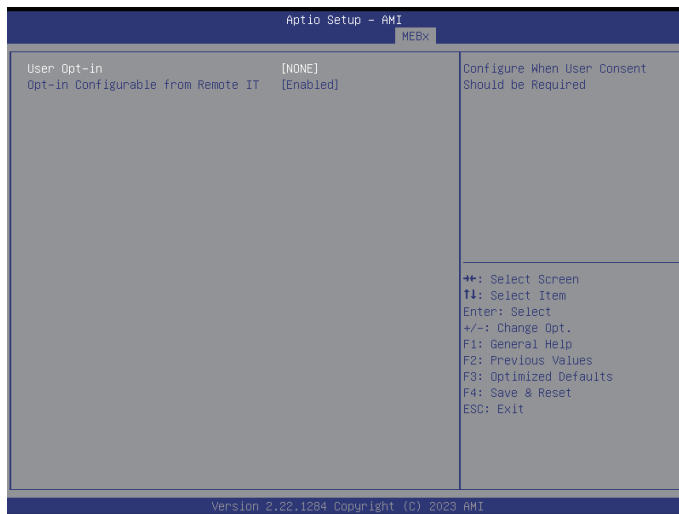

- Follow these steps to navigate the configuration items: **Intel(R) Intel Standard Manageability Configuration > Network Access State**, then change the option to **Network Active**.

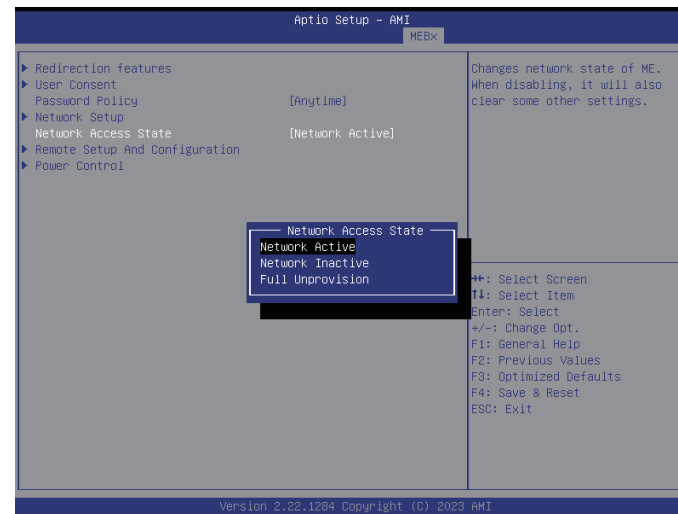

- Return to the BIOS main menu, navigate to the **Save & Exit** tab, and click **Save Changes and Reset** to apply the settings.

6. Enter the operating system and log in to the IAMT configuration web page using `https://ipaddress_of_PC:16993`

For example:

6-1. `https://10.14.5.53:16993`

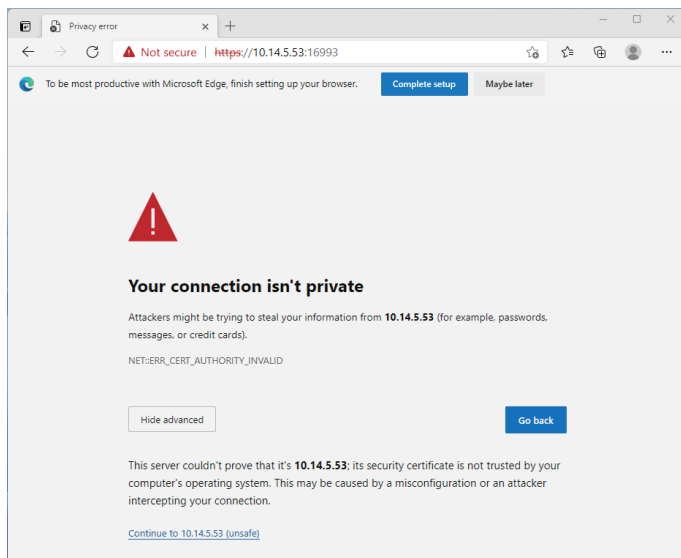

Click the **Continue** if a warning message appears to remind you that the connection isn't private.

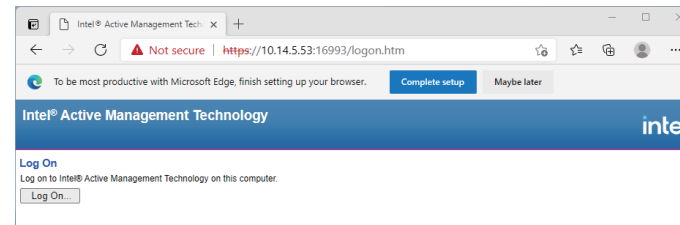

6-2. Account: `admin`

6-3. Password: The password you have changed in step 1.

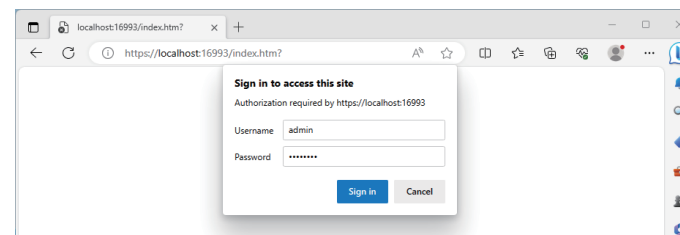

Alternatively, you can access IAMT configuration page by `https://127.0.0.1:16993` or `https://localhost:16993` on local side.

7. The screen should look like the image shown below after a successful login.

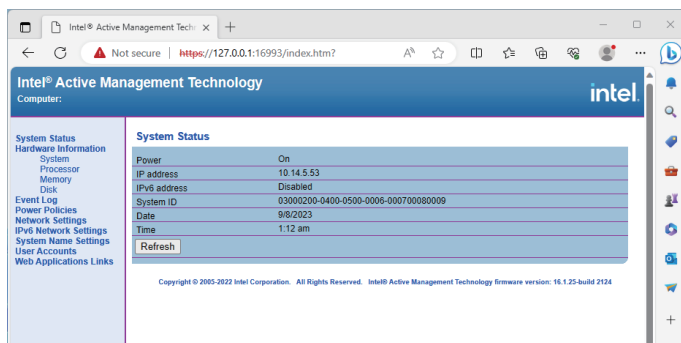

8. Follow the same login procedure as outlined in [step 6](#) using the same address, account, and password. Ensure that the remote control system is in the same network segment as the target system.

9. Once logged in successfully, you will see the remote control page shown below.

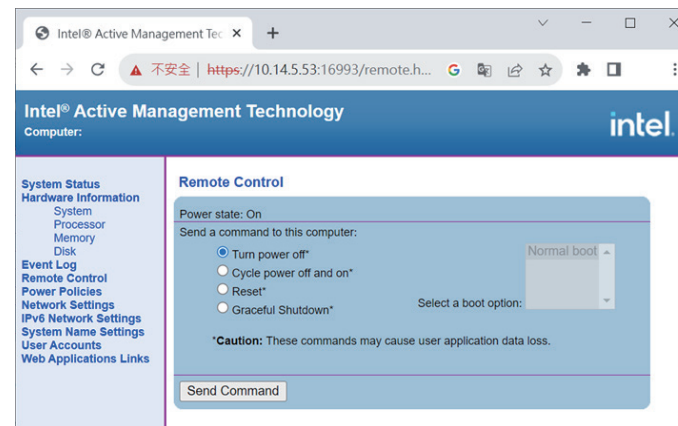
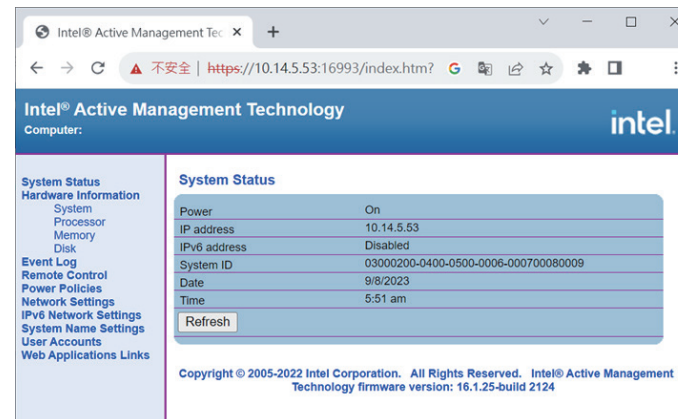

APPENDIX B: PCIe BUS CONFIGURATION

1. Press the <Delete> button to access the BIOS during the boot-up process. Once in the BIOS, navigate to the Chipset tab.
2. Within the Chipset tab, locate the System Agent (SA) Configuration, and then find the setting for PCIe slots (X16 Mode Select).

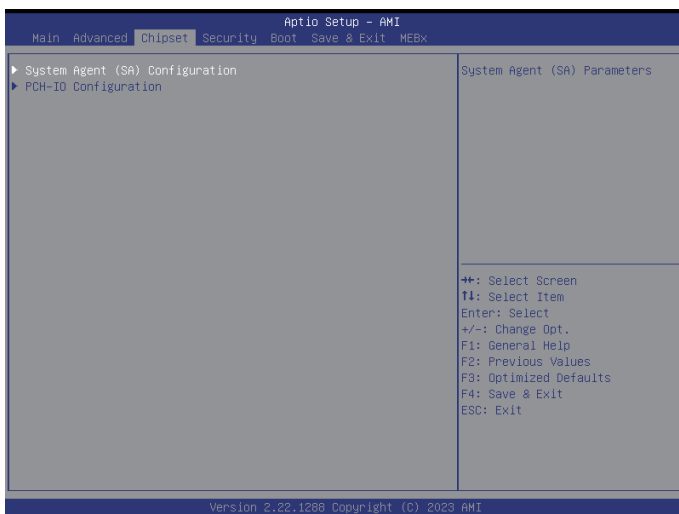

- You will encounter two PCIe slots on the riser card. The upper slot is designed in x16 mode, while the lower slot is in x8 mode.

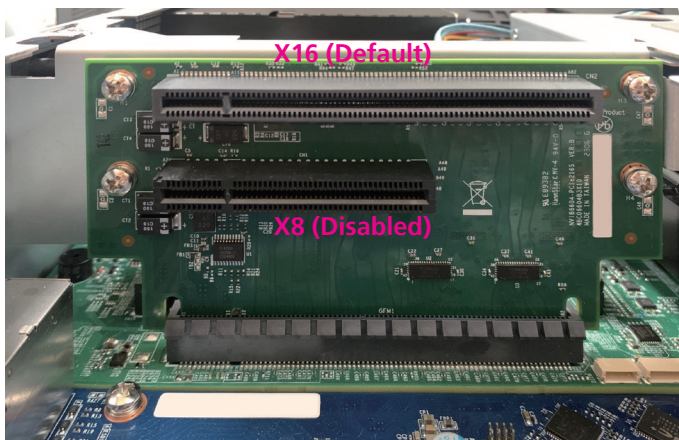

- The usage mode for these two slots depends on the settings configured in the BIOS. If the BIOS is in 1x16 mode, the upper slot will operate in x16 mode, while the lower slot will not be available. Conversely, both slots will operate in x8 mode when selecting 2x8 in the BIOS, and the bandwidth of the upper slot (x16) will be split and shared with the lower slot. By default, the BIOS is set to x16 mode.

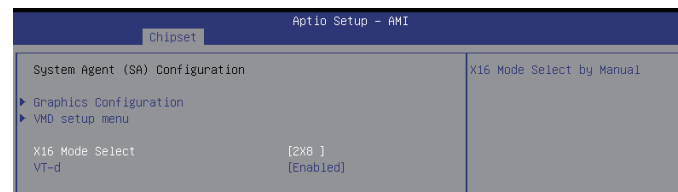
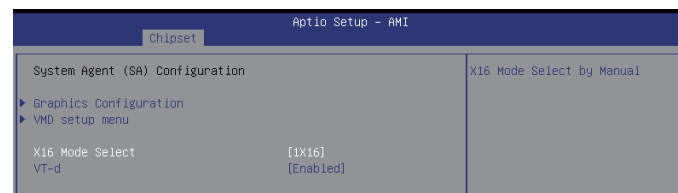

- Once you have configured the desired mode, save the changes and exit the BIOS. Restart your system to apply the new PCIe slot configuration.

APPENDIX C: GPIO INSTRUCTION

Locating the GPIO Connector



The GPIO function is an optional feature. If available, the GPIO expansion board comes pre-installed on the system by default.

- This device boasts a 10-pin GPIO pin conveniently located on its rear panel. This versatile digital pin, controlled by software, can function as an input, output, or both, allowing you to customize its behavior and connect with various external devices.



Understanding GPIO Pin Definitions

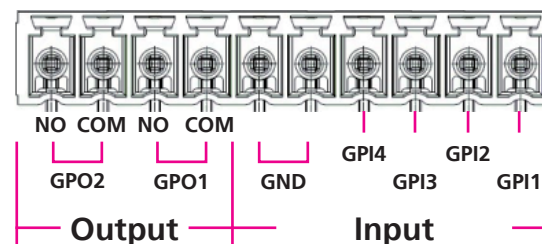

ISO GPIO 4IN_2OUT Block Diagram

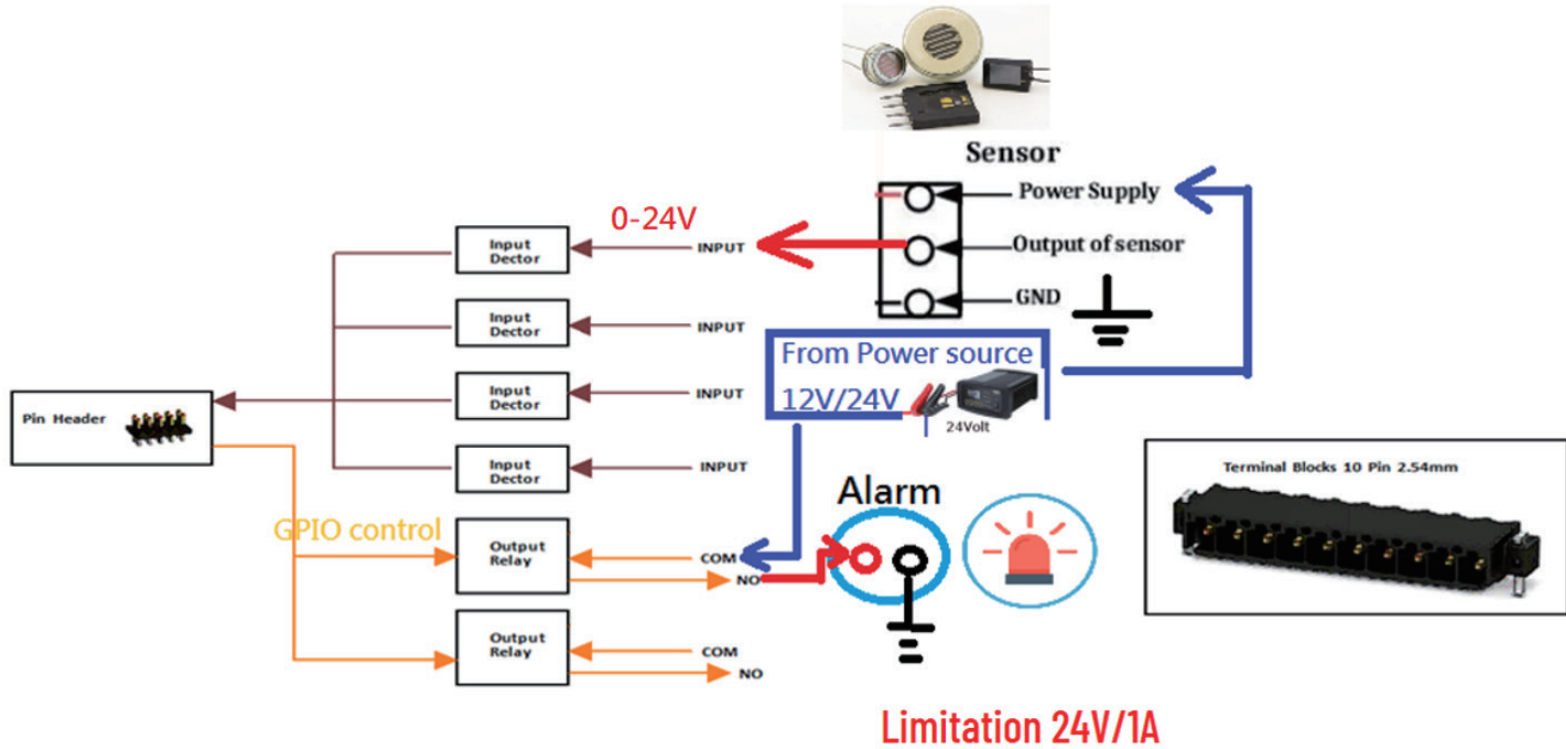

Basic Configuration

1. Download the software from the official website, unzip the file and run the **RN15_GPIO_Sample.exe** file.
2. Follow the images below for configuring the GPIO.

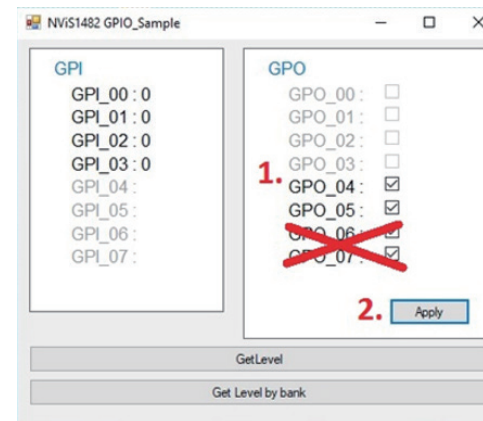
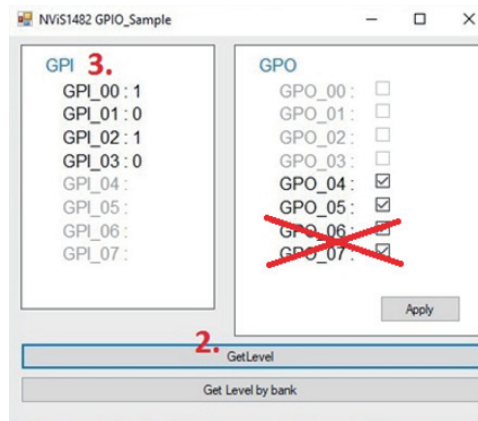
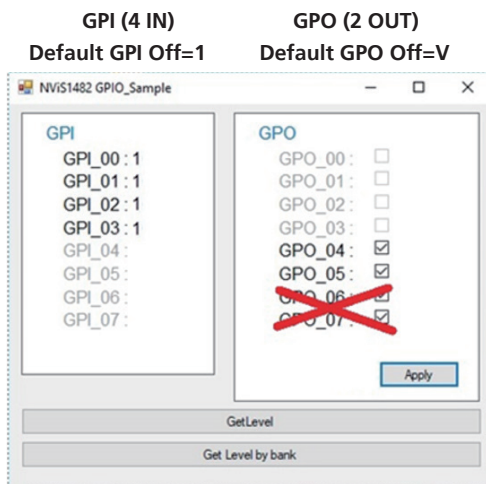

APPENDIX D: NVIS 66162 RAID CONFIGURATION

1. Press the <Delete> button to access the BIOS during the boot-up process. Once in the BIOS, navigate to the Chipset tab.
2. Within the Chipset tab, find the System Agent (SA) Configuration and then go to the VMD Setup menu > Enable VMD controller.



3. Enable the VMD controller, then save the changes and exit the BIOS to apply the settings.
4. Enter the BIOS again and navigate to the Intel(R) Rapid Storage Technology tab.

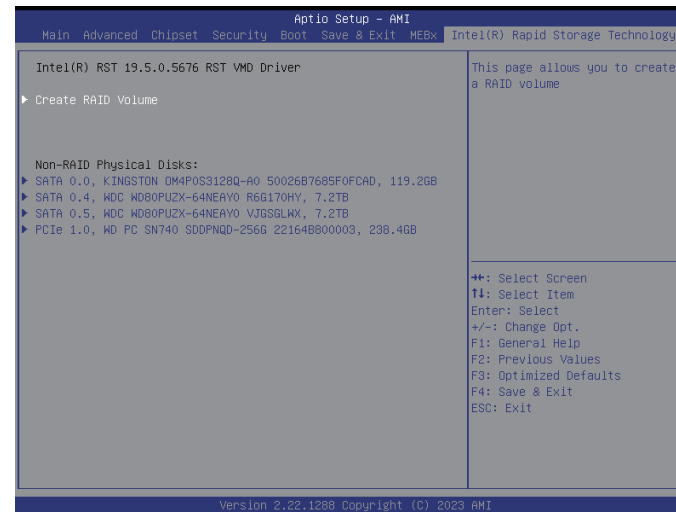
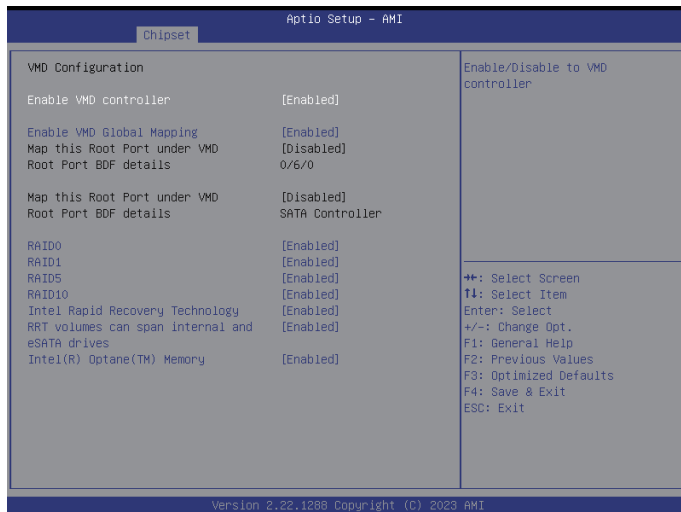

- Enter **Create RAID Volume** item and select the desired RAID level under the **RAID LEVEL** option.

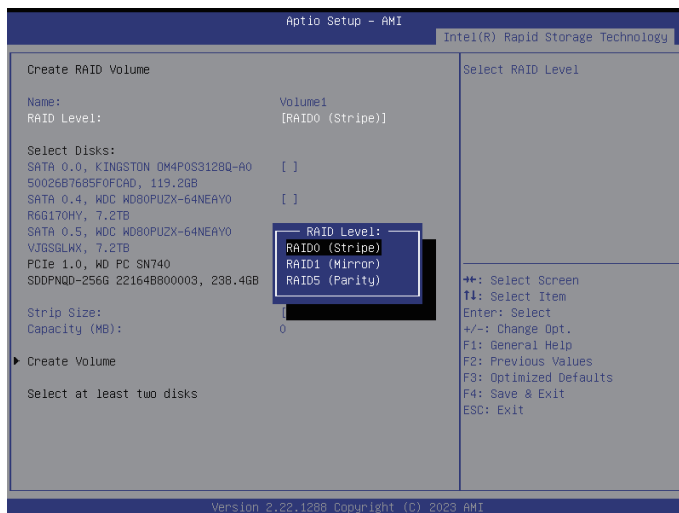

- Use the up or down arrow keys to select the disks and press the <Space> button to confirm the selection. Once you have completed the disk selection, press the <Enter> button to create the RAID volume under the **RAID Volume** option.

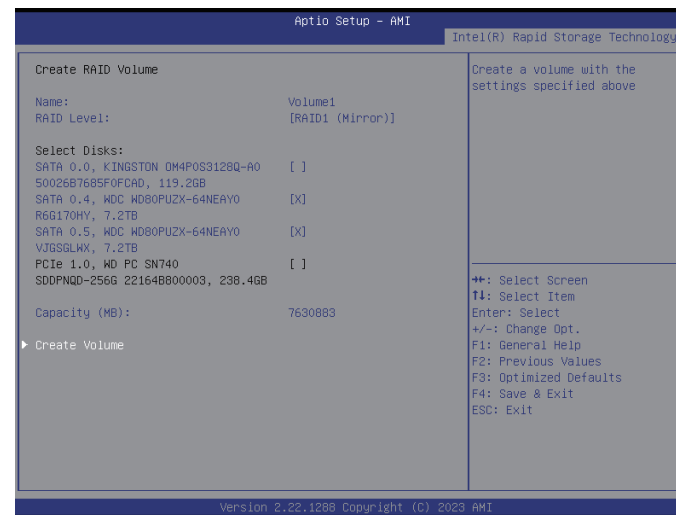

7. The Volume 1 appears when the RAID volume is created.

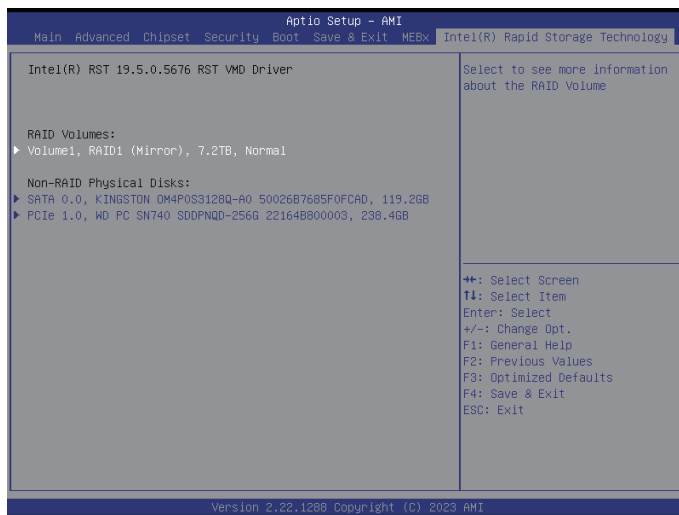

8. Press <Enter> button for more information and configurations.



APPENDIX E: INSTALLING THE SYSTEM IN A RACK

1. The slide rail consists of an inner and outer rail. To separate the inner rail, pull it outwards on the slide rail until it clicks into the locked position. Then, pull the **Front release tab** forward to release the lock and remove the inner rail.
2. Adjust the front and rear brackets to align with the rack ports by loosening the bracket screws. Once properly positioned, re-tighten the screws for secure installation.

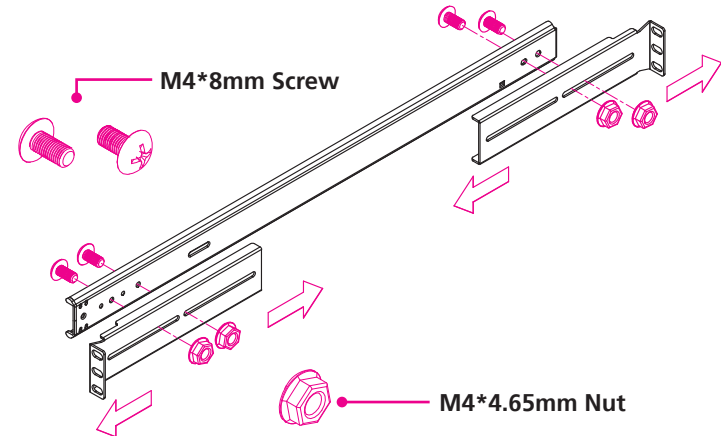
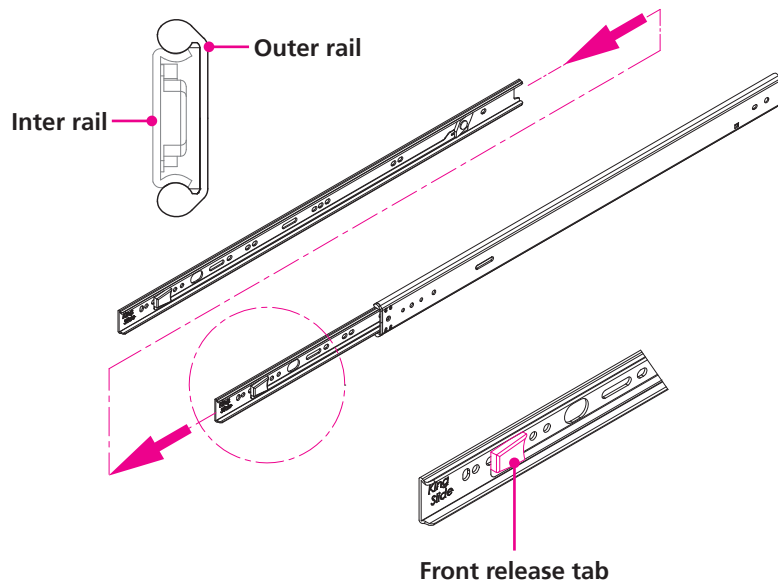

3. Secure the outer rail (with the pre-installed brackets) to the frame of the rack.

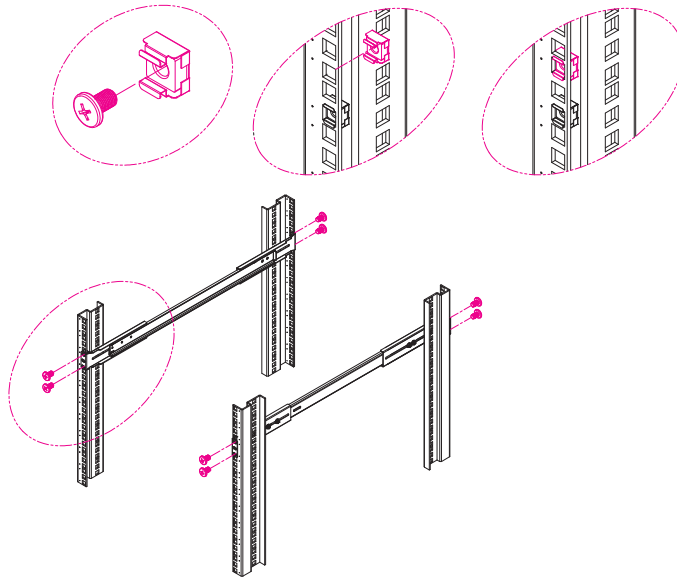

4. Attach the inner rail withdrawn in [step 1](#) to the system.

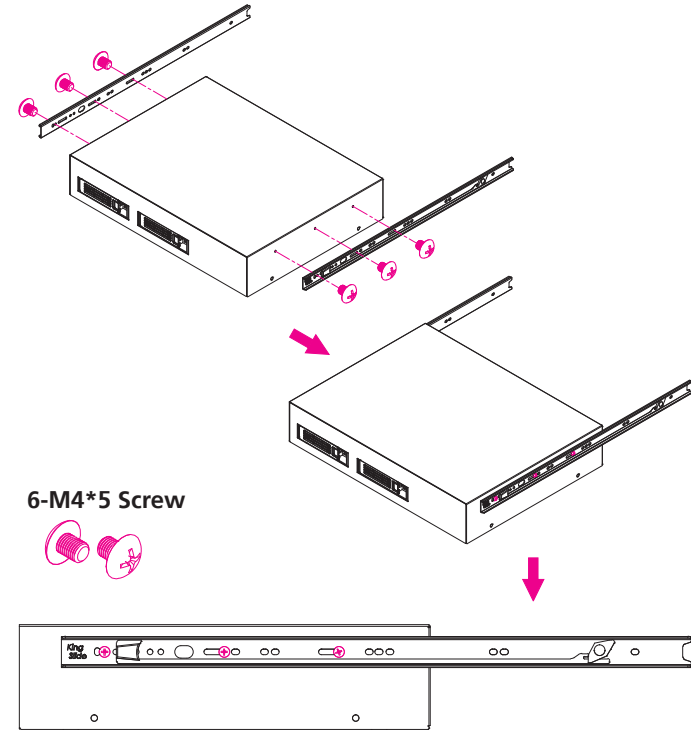

5. Fully insert the system with the installed inner rails into the outer rail until it locks. Release the lock by sliding the **Front release tab** forward, and then secure the system in its final position within the rack.

