



NViS1482/14162 GPIO Design Proposal

Committed to Customer Success

9/26/2023

www.nexcom.com



NViS1482/14162 4IN/20OUT GPIO Design

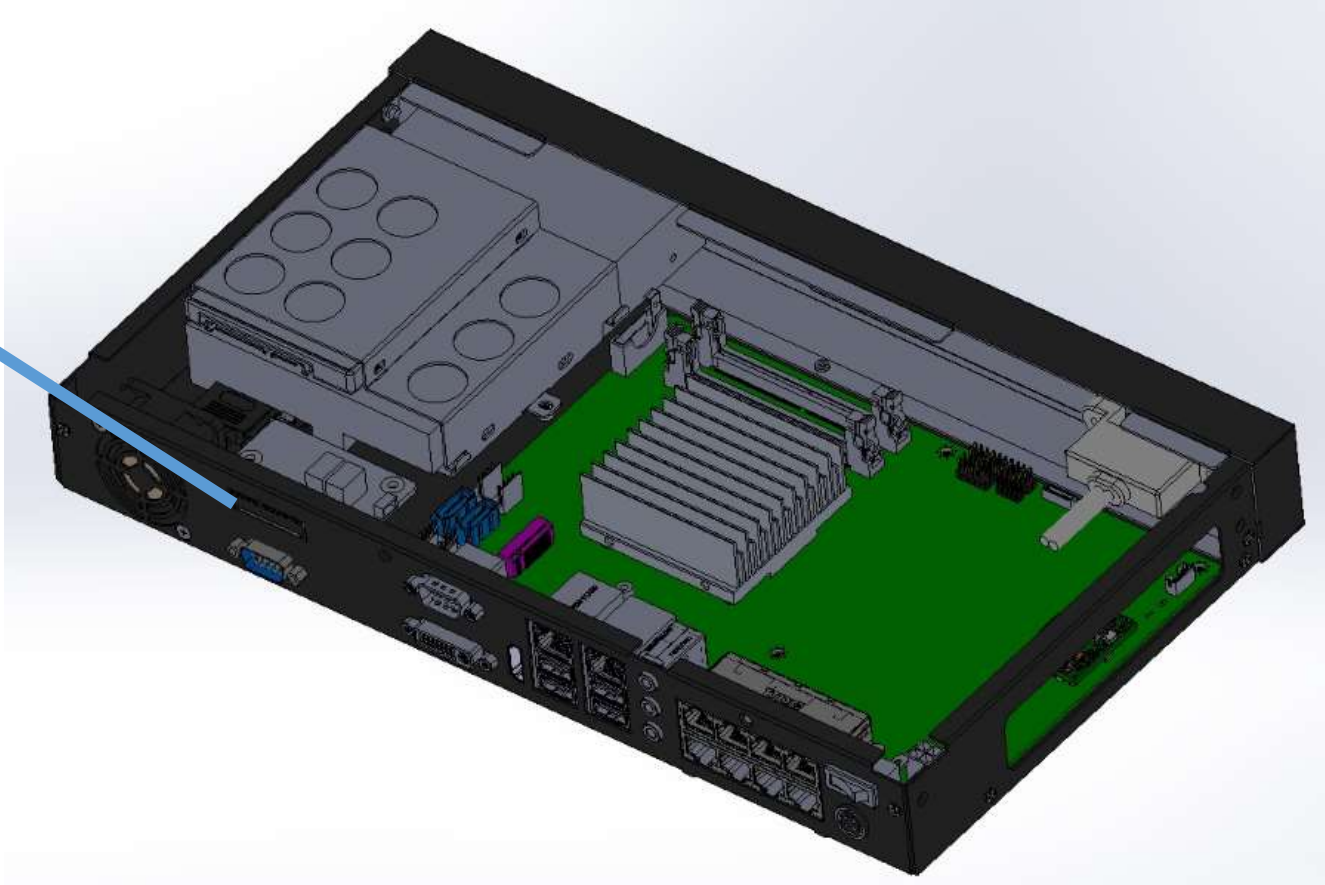
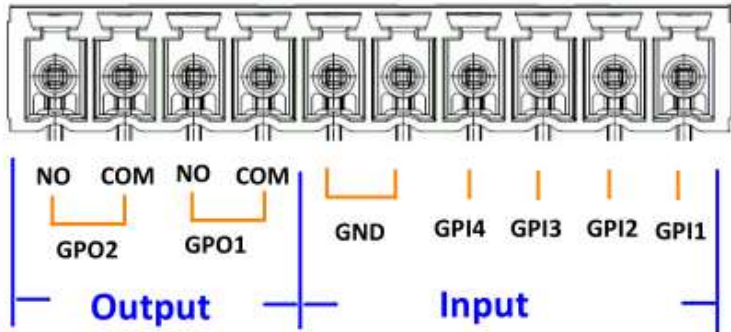
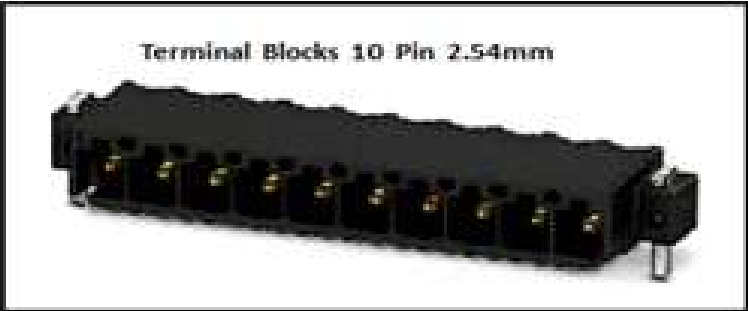

NViS1482/14162 4IN/20OUT Isolated GPIO Design

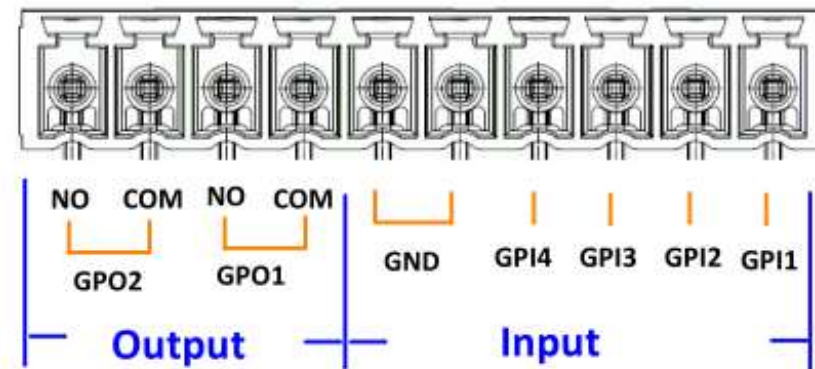
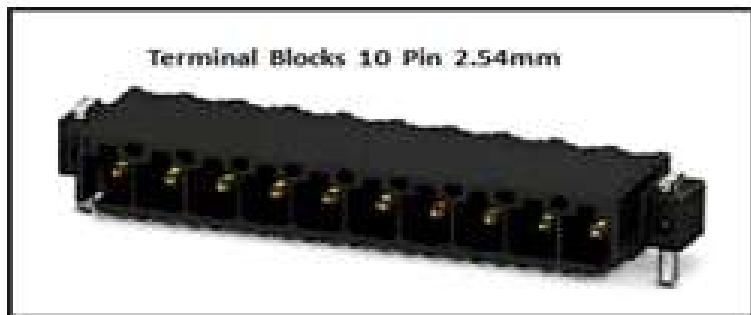

NViS1482/14162 4IN/20OUT Isolated GPIO Design Application

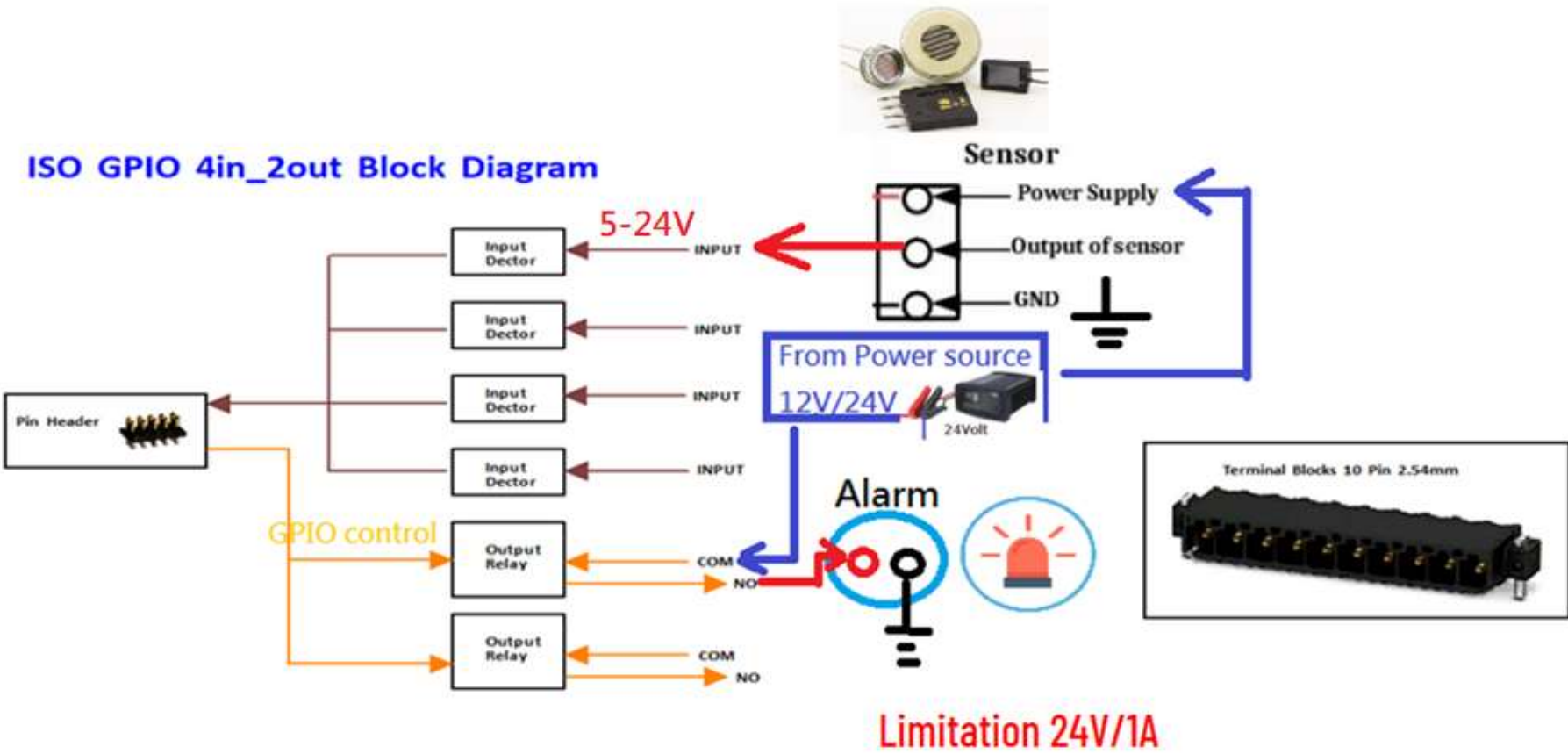

NViS1482 4IN/20OUT SDK Control Initial Status (Windows)

GPI (4 IN)

GPO (2 OUT)

Default
GPI off = 1

The screenshot shows a Windows application window titled "NViS1482 GPIO_Sample". It contains two main panels: "GPI" and "GPO".

GPI Panel: Lists GPI_00 through GPI_07. GPI_00, GPI_01, GPI_02, and GPI_03 are each followed by a colon and the number "1". GPI_04, GPI_05, GPI_06, and GPI_07 are followed by a colon and a space.

GPO Panel: Lists GPO_00 through GPO_07. GPO_00, GPO_01, GPO_02, and GPO_03 are each followed by a colon and an unchecked checkbox. GPO_04, GPO_05, GPO_06, and GPO_07 are each followed by a colon and a checked checkbox. A large red 'X' is drawn over the GPO_06 and GPO_07 entries.

At the bottom of the GPO panel is an "Apply" button. Below the GPO panel are two disabled buttons: "GetLevel" and "Get Level by bank".

Default
GPO off = V

NViS1482 4IN/20OUT SDK Control (Windows)

GPI (4IN)

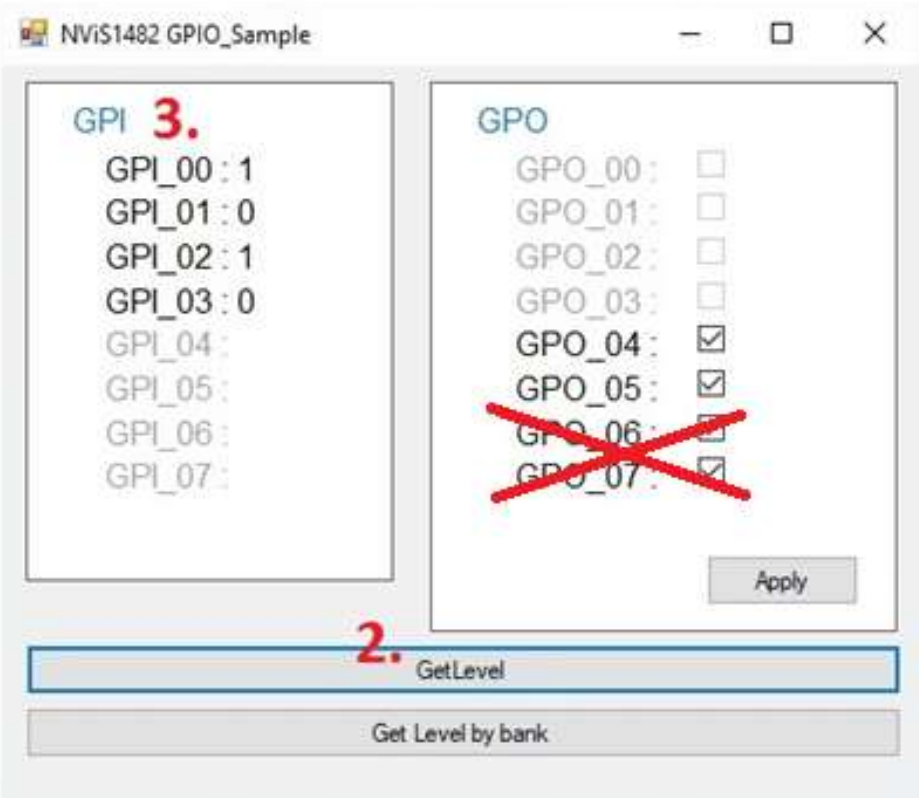

GPO (20OUT)

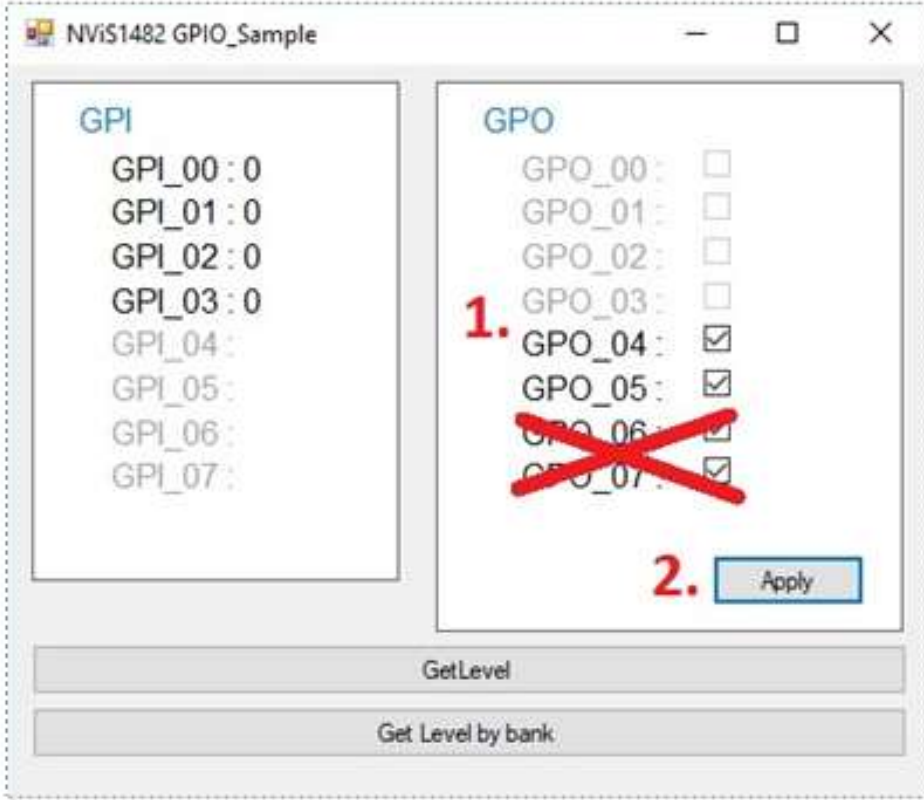



**Thank
You**