



**NEXCOM International Co., Ltd.**

**Network and Communication Solutions**

**Network Security Appliance**

**NSA 5150**

User Manual

# Contents

## Preface

Copyright .....	iv
Disclaimer .....	iv
Acknowledgements .....	iv
Regulatory Compliance Statements .....	iv
Declaration of Conformity .....	iv
RoHS Compliance .....	v
Warranty and RMA .....	vi
Safety Information .....	viii
Installation Recommendations .....	viii
Safety Precautions .....	ix
Technical Support and Assistance .....	x
Conventions Used in this Manual .....	x
Global Service Contact Information .....	xi
Package Contents .....	xiii
Ordering Information .....	xiv

## Chapter 1: Product Introduction

Overview .....	1
Key Features .....	1
Hardware Specifications .....	2
Knowing Your NSA 5150 .....	3
Front Panel .....	3
Rear Panel .....	4

## Chapter 2: Jumpers and Connectors

Before You Begin .....	5
Precautions .....	5
Jumper Settings .....	6
Locations of the Jumpers and Connectors .....	7
Jumpers .....	8
RTC Clear .....	8
ATX/AT Select .....	8
Console Pin Header .....	9
WDTO Pin Header .....	9
Connector Pin Definitions .....	10
External I/O Interfaces .....	10
Reset Button .....	10
RS232 Console Port .....	10
Dual USB 3.0 Ports .....	11
LAN Ports .....	12
Connector Pin Definitions .....	14
Internal Connectors .....	14
Digital IO (4 Input/4 Output) .....	14
COM 2 Box Header Connector (RS232) .....	14
BMC COM .....	15
USB2 Box Header .....	15
HW Reset Pin Header .....	16
Power Button Pin Header .....	16
NMI Pin Header .....	17
Bypass LED Pin Header .....	17

Power LED Pin Header .....	18
HDD LED Pin Header .....	18
GAL Programming Connector .....	19
BMC Programming Connector .....	19
BMC Reset Pin Header .....	20
System Fan Connector (4-Pin).....	20
System Fan Connectors (3-Pin).....	21
Intrusion Detect Connector .....	21
Internal MO-297 Connector .....	22
SATA Connectors .....	22
SATA DOM Power Port.....	23
Keyboard/Mouse Connector.....	23
VGA Connector .....	24
VGA Connector .....	24
Parallel Interface for LCM Module .....	25
Keypad Pin Header .....	25
PSMI Connector .....	26
Power Connector .....	26
Power Connector .....	27
PCIe x4 Slot.....	28
LAN Module Slot.....	29

## Chapter 3: System Setup

Removing the Chassis Cover .....	33
Installing a SATA DOM .....	34
Installing a MO-297 SSD Module .....	37
Installing a SO DIMM .....	39
Installing a 3.5" SATA Hard Drive .....	40
Installing a LAN Module .....	44

## Chapter 4: BIOS Setup

About BIOS Setup .....	46
When to Configure the BIOS.....	46
Default Configuration .....	47
Entering Setup .....	47
Legends .....	47
BIOS Setup Utility .....	49
Main .....	49
Advanced .....	50
Chipset.....	60
Boot.....	64
Security .....	66
Save & Exit .....	66

## Appendix A: Bypass Register

Register Map .....	68
Register Bit Definitions .....	69

# Preface

## Copyright

This publication, including all photographs, illustrations and software, is protected under international copyright laws, with all rights reserved. No part of this manual may be reproduced, copied, translated or transmitted in any form or by any means without the prior written consent from NEXCOM International Co., Ltd.

## Disclaimer

The information in this document is subject to change without prior notice and does not represent commitment from NEXCOM International Co., Ltd. However, users may update their knowledge of any product in use by constantly checking its manual posted on our website: <http://www.nexcom.com>. NEXCOM shall not be liable for direct, indirect, special, incidental, or consequential damages arising out of the use of any product, nor for any infringements upon the rights of third parties, which may result from such use. Any implied warranties of merchantability or fitness for any particular purpose is also disclaimed.

## Acknowledgements

NSA 5150 is a trademark of NEXCOM International Co., Ltd. All other product names mentioned herein are registered trademarks of their respective owners.

## Regulatory Compliance Statements

This section provides the FCC compliance statement for Class B devices and describes how to keep the system CE compliant.

## Declaration of Conformity

### FCC

This equipment has been tested and verified to comply with the limits for a Class B digital device, pursuant to Part 15 of FCC Rules. These limits are designed to provide reasonable protection against harmful interference when the equipment is operated in a commercial environment. This equipment generates, uses, and can radiate radio frequency energy and, if not installed and used in accordance with the instructions, may cause harmful interference to radio communications. Operation of this equipment in a residential area (domestic environment) is likely to cause harmful interference, in which case the user will be required to correct the interference (take adequate measures) at their own expense.

### CE

The product(s) described in this manual complies with all applicable European Union (CE) directives if it has a CE marking. For computer systems to remain CE compliant, only CE-compliant parts may be used. Maintaining CE compliance also requires proper cable and cabling techniques.

## RoHS Compliance



### **NEXCOM RoHS Environmental Policy and Status Update**

NEXCOM is a global citizen for building the digital infrastructure. We are committed to providing green products and services, which are compliant with European Union RoHS (Restriction on Use of Hazardous Substance in Electronic Equipment) directive 2002/95/EU, to be your trusted green partner and to protect our environment.

RoHS restricts the use of Lead (Pb) < 0.1% or 1,000ppm, Mercury (Hg) < 0.1% or 1,000ppm, Cadmium (Cd) < 0.01% or 100ppm, Hexavalent Chromium (Cr6+) < 0.1% or 1,000ppm, Polybrominated biphenyls (PBB) < 0.1% or 1,000ppm, and Polybrominated diphenyl Ethers (PBDE) < 0.1% or 1,000ppm.

In order to meet the RoHS compliant directives, NEXCOM has established an engineering and manufacturing task force in to implement the introduction of green products. The task force will ensure that we follow the standard NEXCOM development procedure and that all the new RoHS components and new manufacturing processes maintain the highest industry quality levels for which NEXCOM are renowned.

The model selection criteria will be based on market demand. Vendors and suppliers will ensure that all designed components will be RoHS compliant.

### **How to recognize NEXCOM RoHS Products?**

For existing products where there are non-RoHS and RoHS versions, the suffix "(LF)" will be added to the compliant product name.

All new product models launched after January 2006 will be RoHS compliant. They will use the usual NEXCOM naming convention.

## Warranty and RMA

### NEXCOM Warranty Period

NEXCOM manufactures products that are new or equivalent to new in accordance with industry standard. NEXCOM warrants that products will be free from defect in material and workmanship for 2 years, beginning on the date of invoice by NEXCOM. HCP series products (Blade Server) which are manufactured by NEXCOM are covered by a three year warranty period.

### NEXCOM Return Merchandise Authorization (RMA)

- Customers shall enclose the “NEXCOM RMA Service Form” with the returned packages.
- Customers must collect all the information about the problems encountered and note anything abnormal or, print out any on-screen messages, and describe the problems on the “NEXCOM RMA Service Form” for the RMA number apply process.
- Customers can send back the faulty products with or without accessories (manuals, cable, etc.) and any components from the card, such as CPU and RAM. If the components were suspected as part of the problems, please note clearly which components are included. Otherwise, NEXCOM is not responsible for the devices/parts.
- Customers are responsible for the safe packaging of defective products, making sure it is durable enough to be resistant against further damage and deterioration during transportation. In case of damages occurred during transportation, the repair is treated as “Out of Warranty.”
- Any products returned by NEXCOM to other locations besides the customers’ site will bear an extra charge and will be billed to the customer.

### Repair Service Charges for Out-of-Warranty Products

NEXCOM will charge for out-of-warranty products in two categories, one is basic diagnostic fee and another is component (product) fee.

### Repair Service Charges for Out-of-Warranty Products

NEXCOM will charge for out-of-warranty products in two categories, one is basic diagnostic fee and another is component (product) fee.

### System Level

- Component fee: NEXCOM will only charge for main components such as SMD chip, BGA chip, etc. Passive components will be repaired for free, ex: resistor, capacitor.
- Items will be replaced with NEXCOM products if the original one cannot be repaired. Ex: motherboard, power supply, etc.
- Replace with 3rd party products if needed.
- If RMA goods can not be repaired, NEXCOM will return it to the customer without any charge.

### Board Level

- Component fee: NEXCOM will only charge for main components, such as SMD chip, BGA chip, etc. Passive components will be repaired for free, ex: resistors, capacitors.
- If RMA goods can not be repaired, NEXCOM will return it to the customer without any charge.

## Warnings

Read and adhere to all warnings, cautions, and notices in this guide and the documentation supplied with the chassis, power supply, and accessory modules. If the instructions for the chassis and power supply are inconsistent with these instructions or the instructions for accessory modules, contact the supplier to find out how you can ensure that your computer meets safety and regulatory requirements.

## Cautions

Electrostatic discharge (ESD) can damage system components. Do the described procedures only at an ESD workstation. If no such station is available, you can provide some ESD protection by wearing an antistatic wrist strap and attaching it to a metal part of the computer chassis.

## Safety Information

Before installing and using the device, note the following precautions:

- Read all instructions carefully.
- Do not place the unit on an unstable surface, cart, or stand.
- Follow all warnings and cautions in this manual.
- When replacing parts, ensure that your service technician uses parts specified by the manufacturer.
- Avoid using the system near water, in direct sunlight, or near a heating device.
- The load of the system unit does not solely rely for support from the rackmounts located on the sides. Firm support from the bottom is highly necessary in order to provide balance stability.
- The computer is provided with a battery-powered real-time clock circuit. There is a danger of explosion if battery is incorrectly replaced. Replace only with the same or equivalent type recommended by the manufacturer. Discard used batteries according to the manufacturer's instructions.

## Installation Recommendations

Ensure you have a stable, clean working environment. Dust and dirt can get into components and cause a malfunction. Use containers to keep small components separated.

Adequate lighting and proper tools can prevent you from accidentally damaging the internal components. Most of the procedures that follow require only a few simple tools, including the following:

- A Philips screwdriver
- A flat-tipped screwdriver
- A grounding strap
- An anti-static pad

Using your fingers can disconnect most of the connections. It is recommended that you do not use needle-nose pliers to disconnect connections as these can damage the soft metal or plastic parts of the connectors.



## Safety Precautions

1. Read these safety instructions carefully.
2. Keep this User Manual for later reference.
3. Disconnect this equipment from any AC outlet before cleaning. Use a damp cloth. Do not use liquid or spray detergents for cleaning.
4. For plug-in equipment, the power outlet socket must be located near the equipment and must be easily accessible.
5. Keep this equipment away from humidity.
6. Put this equipment on a stable surface during installation. Dropping it or letting it fall may cause damage.
7. The openings on the enclosure are for air convection to protect the equipment from overheating. **DO NOT COVER THE OPENINGS.**
8. Make sure the voltage of the power source is correct before connecting the equipment to the power outlet.
9. Place the power cord in a way so that people will not step on it. Do not place anything on top of the power cord. Use a power cord that has been approved for use with the product and that it matches the voltage and current marked on the product's electrical range label. The voltage and current rating of the cord must be greater than the voltage and current rating marked on the product.
10. All cautions and warnings on the equipment should be noted.
11. If the equipment is not used for a long time, disconnect it from the power source to avoid damage by transient overvoltage.
12. Never pour any liquid into an opening. This may cause fire or electrical shock.
13. Never open the equipment. For safety reasons, the equipment should be opened only by qualified service personnel.
14. If one of the following situations arises, get the equipment checked by service personnel:
  - a. The power cord or plug is damaged.
  - b. Liquid has penetrated into the equipment.
  - c. The equipment has been exposed to moisture.
  - d. The equipment does not work well, or you cannot get it to work according to the user's manual.
  - e. The equipment has been dropped and damaged.
  - f. The equipment has obvious signs of breakage.
15. Do not place heavy objects on the equipment.
16. The unit uses a three-wire ground cable which is equipped with a third pin to ground the unit and prevent electric shock. Do not defeat the purpose of this pin. If your outlet does not support this kind of plug, contact your electrician to replace your obsolete outlet.
17. **CAUTION: DANGER OF EXPLOSION IF BATTERY IS INCORRECTLY REPLACED. REPLACE ONLY WITH THE SAME OR EQUIVALENT TYPE RECOMMENDED BY THE MANUFACTURER. DISCARD USED BATTERIES ACCORDING TO THE MANUFACTURER'S INSTRUCTIONS.**

## Technical Support and Assistance

1. For the most updated information of NEXCOM products, visit NEXCOM's website at [www.nexcom.com](http://www.nexcom.com).
2. For technical issues that require contacting our technical support team or sales representative, please have the following information ready before calling:
  - Product name and serial number
  - Detailed information of the peripheral devices
  - Detailed information of the installed software (operating system, version, application software, etc.)
  - A complete description of the problem
  - The exact wordings of the error messages

### Warning!

1. Handling the unit: carry the unit with both hands and handle it with care.
2. Maintenance: to keep the unit clean, use only approved cleaning products or clean with a dry cloth.
3. CompactFlash: Turn off the unit's power before inserting or removing a CompactFlash storage card.

## Conventions Used in this Manual



### Warning:

Information about certain situations, which if not observed, can cause personal injury. This will prevent injury to yourself when performing a task.



### Caution:

Information to avoid damaging components or losing data.



### Note:

Provides additional information to complete a task easily.

## Global Service Contact Information

### Headquarters

#### **NEXCOM International Co., Ltd.**

15F, No. 920, Chung-Cheng Rd.,  
ZhongHe District, New Taipei City, 23586,  
Taiwan, R.O.C.

Tel: +886-2-8226-7786

Fax: +886-2-8226-7782

[www.nexcom.com](http://www.nexcom.com)

### America

#### **USA**

#### **NEXCOM USA**

2883 Bayview Drive,  
Fremont CA 94538, USA

Tel: +1-510-656-2248

Fax: +1-510-656-2158

Email: [sales@nexcom.com](mailto:sales@nexcom.com)

[www.nexcom.com](http://www.nexcom.com)

### Asia

#### **Taiwan**

#### **NEXCOM Intelligent Systems**

#### **Taipei Office**

13F, No.920, Chung-Cheng Rd.,  
ZhongHe District,  
New Taipei City, 23586, Taiwan, R.O.C.

Tel: +886-2-8226-7796

Fax: +886-2-8226-7792

Email: [sales@nexcom.com.tw](mailto:sales@nexcom.com.tw)

[www.nexcom.com.tw](http://www.nexcom.com.tw)

### **NEXCOM Intelligent Systems**

#### **Taichung Office**

16F, No.250, Sec. 2, Chongde Rd.,  
Beitun Dist.,

Taichung City 406, R.O.C.

Tel: +886-4-2249-1179

Fax: +886-4-2249-1172

Email: [sales@nexcom.com.tw](mailto:sales@nexcom.com.tw)

[www.nexcom.com.tw](http://www.nexcom.com.tw)

### **Japan**

#### **NEXCOM Japan**

9F, Tamachi Hara Bldg.,  
4-11-5, Shiba Minato-ku,  
Tokyo, 108-0014, Japan

Tel: +81-3-5419-7830

Fax: +81-3-5419-7832

Email: [sales@nexcom-jp.com](mailto:sales@nexcom-jp.com)

[www.nexcom-jp.com](http://www.nexcom-jp.com)

### **China**

#### **NEXCOM China**

1F & 2F, Block A, No. 16 Yonyou Software Park,  
No. 68 Beiqing Road, Haidian District,  
Beijing, 100094, China

Tel: +86-010-5704-2680

Fax: +86-010-5704-2681

Email: [sales@nexcom.cn](mailto:sales@nexcom.cn)

[www.nexcom.cn](http://www.nexcom.cn)

### **Chengdu Office**

9F, Shuxiangxie, Xuefu Garden,  
No.12 Section 1, South Yihuan Rd.,  
Chengdu, 610061, China  
Tel: +86-28-8523-0186  
Fax: +86-28-8523-0186  
Email: sales@nexcom.cn  
www.nexcom.cn

### **Shanghai Office**

Room 603/604, Huiyinmingzun Plaza Bldg., 1,  
No.609, Yunlin East Rd.,  
Shanghai, 200333, China  
Tel: +86-21-5278-5868  
Fax: +86-21-3251-6358  
Email: sales@nexcom.cn  
www.nexcom.cn

### **Shenzhen Office**

Room1707, North Block, Pines Bldg.,  
No.7 Tairan Rd., Futian Area,  
Shenzhen, 518040, China  
Tel: +86-755-8332-7203  
Fax: +86-755-8332-7213  
Email: sales@nexcom.cn  
www.nexcom.cn

### **Wuhan Office**

1-C1804/1805, Mingze Liwan, No. 519  
South Luoshi Rd., Hongshan District,  
Wuhan, 430070, China  
Tel: +86-27-8722-7400  
Fax: +86-27-8722-7400  
Email: sales@nexcom.cn  
www.nexcom.cn

### **Europe**

#### **United Kingdom**

#### **NEXCOM EUROPE**

10 Vincent Avenue,  
Crownhill Business Centre,  
Milton Keynes, Buckinghamshire  
MK8 0AB, United Kingdom  
Tel: +44-1908-267121  
Fax: +44-1908-262042  
Email: sales.uk@nexcom.eu  
www.nexcom.eu

### **Italy**

#### **NEXCOM ITALIA S.r.l**

Via Gaudenzio Ferrari 29,  
21047 Saronno (VA), Italia  
Tel: +39 02 9628 0333  
Fax: +39 02 9625570  
Email: nexcomitalia@nexcom.eu  
www.nexcomitalia.it

## Package Contents

Before continuing, verify that the NSA 5150 package that you received is complete. Your package should have all the items listed in the following table.

Item	Part Number	Name	Description	Qty
1	5044440031X00	Rubber Foot Kang Yang: RF20-5-4P	19.8x18x5.0mm	4
2	6012200052X00	PE Zipper Bag #8	170x240mm, W/China RoHS SYMBOL	1
3	6012200053X00	PE Zipper Bag #3	100x70mm, W/China RoHS SYMBOL	1
4	6023309081X00	Cable EDI: 232091081804-RS	COM Port. DB9 Female To RJ45 8P8C L:1800mm	1
5	6029900037X00	DOW Corning 340 Silicone Heat Sink Compound(3g)		1
6	50311F0102X00	(H)Round Head Screw Long FEI: P6#32Tx 1/4/SW7*0.8	W/Spring+Flat Washer P6#32Tx 1/4/SW7x0.8 NI	4
7	60233AT133X00	SATA Cable ST: MD-6102042	SATA 7P 180D(LOCK) TO 7P 90D(LOCK) L=135mm	1
8	6014401754X00	NSA 5150 Membrane with LCM VER: A GREATWOOD	42x427.8x0.582mm	1
9	5060900301X00	NSA 5130 Ear Sets VER: A CHYUAN-JYH	79.5x43.5x26mm AL Pantone 295U	1
10	50311F0148X00	(H)Screw Long FEI: P4#40T*1/4 NIGP	P#4-40TX6.35mm (NI)	1
11	602DCD0757X00	(E)NSA 5150 CD Driver VER: 1.0	JCL	1

---



## Ordering Information

The following below provides ordering information for NSA 5150.

### **Barebone**

#### **NSA 5150 (P/N: 10S00515000X0)**

Support 4th generation Intel® Core™ processors, 4 DDR3 memory slots, 8PCIe GbE LAN ports, MO-297 socket, USB ports, VGA port, one PCIe x4 expansion slot, w/o LCM

# Chapter 1: Product Introduction

## Overview



## Key Features

- 1U rackmount network platform
- Intel® 4th generation Core™ processors
- Support four DDR3 1333/1600 memory, up to 32GB
- Support one PCIe x8 expansion
- Internal one 3.5" HDD bay/two 2.5" HDD bay (Optional)

## Hardware Specifications

### Main Board

- NSB 5150
- Support 4th generation Intel® Core™ processors
- Intel® C226

### Main Memory

- 4x 240-pin DDR3 1333/1600MHz DIMM sockets, up to 32GB ECC SDRAM

### LAN Features

- LAN Chip : Intel® I350
- Support 10/100/1000 link speed
- LAN Bypass : 4pairs

### Expansion

- 1x PCIe x4 slot
- 1x LAN module

### I/O Interface-Front

- Power status/HDD status/LAN status/Bypass status LEDs
- 2x USB 2.0 ports
- 1x RJ45 type console port
- 8x copper LAN ports
- 1x LAN Module (Optional)

### I/O Interface-Rear

- 1x expansion slot
- 2x USB 2.0 ports
- 1x VGA port

### Devices

- 1x MO-297 socket
- 1x internal 3.5" HDD bay/two 2.5" HDD Bay (Optional)
- 1x SATA-DOM device space

### Power Input

- 250W ATX power supply/200W 1+1 redundant power supply (Optional)

### Chassis Dimensions

- Chassis Dimension : 430mm x 450mm x 44mm
- Carton Dimension : 560mm x 620mm x 190mm

### Weight

- Without packing: 8Kg
- With packing: 12Kg

### Certifications

- CE approval
- FCC Class A
- UL



# Knowing Your NSA 5150

## Front Panel

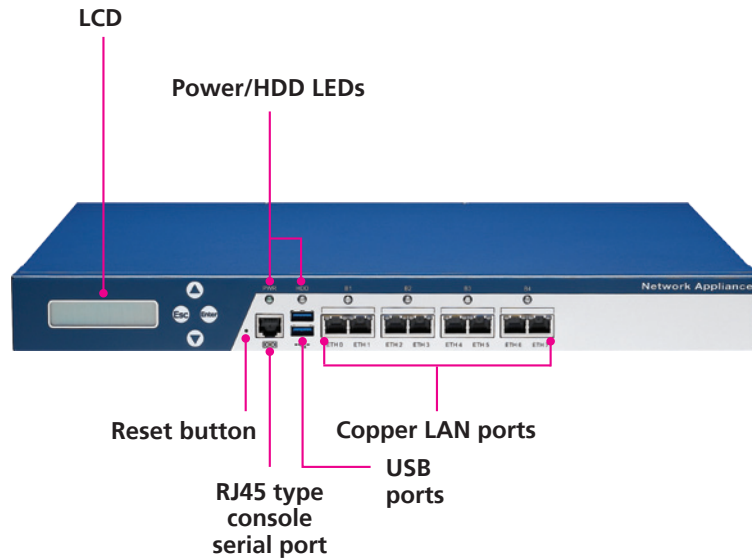

### LCD

2x16 characters LCD module, PIO interface.

### Reset Button

Press to restart the system.

### Power LED

Indicates the power status of the system.

### HDD LED

Indicates the status of the hard drive.

### RJ45 Type Console Serial Port

Used to connect RJ45 type console devices.

### USB Ports

Used to connect USB 3.0/2.0 devices.

### Copper LAN Ports

Used to connect LAN network devices.

## Rear Panel

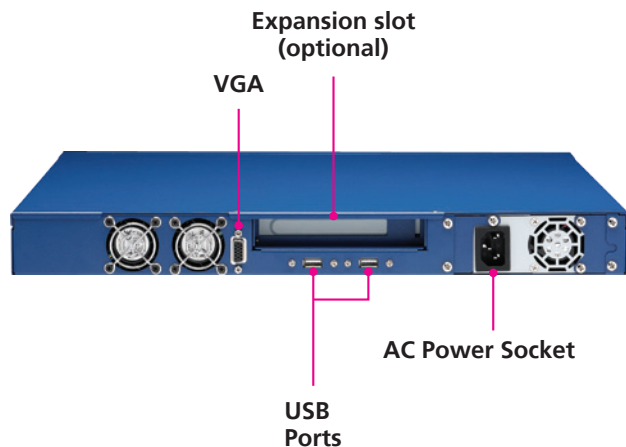

### Expansion Slot

Used to install a PCI Express x8 card.

### VGA

Used to connect an analog VGA monitor.

### USB Ports

Used to connect USB 2.0/1.1 devices.

### AC Power Socket

Plug an AC power cord here before turning on the system.

# Chapter 2: Jumpers and Connectors

This chapter describes how to set the jumpers and connectors on the NSA 5150 motherboard.

## Before You Begin

- Ensure you have a stable, clean working environment. Dust and dirt can get into components and cause a malfunction. Use containers to keep small components separated.
- Adequate lighting and proper tools can prevent you from accidentally damaging the internal components. Most of the procedures that follow require only a few simple tools, including the following:
  - A Philips screwdriver
  - A flat-tipped screwdriver
  - A set of jewelers screwdrivers
  - A grounding strap
  - An anti-static pad
- Using your fingers can disconnect most of the connections. It is recommended that you do not use needle-nosed pliers to disconnect connections as these can damage the soft metal or plastic parts of the connectors.
- Before working on internal components, make sure that the power is off. Ground yourself before touching any internal components, by touching a metal object. Static electricity can damage many of the electronic components. Humid environments tend to have less static electricity than

dry environments. A grounding strap is warranted whenever danger of static electricity exists.

## Precautions

Computer components and electronic circuit boards can be damaged by discharges of static electricity. Working on computers that are still connected to a power supply can be extremely dangerous.

Follow the guidelines below to avoid damage to your computer or yourself:

- Always disconnect the unit from the power outlet whenever you are working inside the case.
- If possible, wear a grounded wrist strap when you are working inside the computer case. Alternatively, discharge any static electricity by touching the bare metal chassis of the unit case, or the bare metal body of any other grounded appliance.
- Hold electronic circuit boards by the edges only. Do not touch the components on the board unless it is necessary to do so. Don't flex or stress the circuit board.
- Leave all components inside the static-proof packaging that they shipped with until they are ready for installation.
- Use correct screws and do not over tighten screws.

## Jumper Settings

A jumper is the simplest kind of electric switch. It consists of two metal pins and a cap. When setting the jumpers, ensure that the jumper caps are placed on the correct pins. When the jumper cap is placed on both pins, the jumper is short. If you remove the jumper cap, or place the jumper cap on just one pin, the jumper is open.

Refer to the illustrations below for examples of what the 2-pin and 3-pin jumpers look like when they are short (on) and open (off).

Two-Pin Jumpers: Open (Left) and Short (Right)

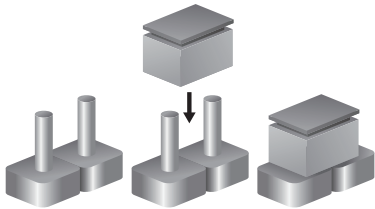

Three-Pin Jumpers: Pins 1 and 2 are Short

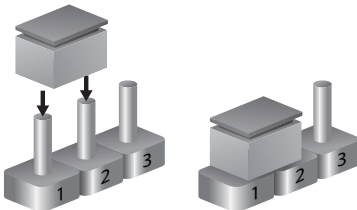

# Locations of the Jumpers and Connectors

The figure below shows the location of the jumpers and connectors.

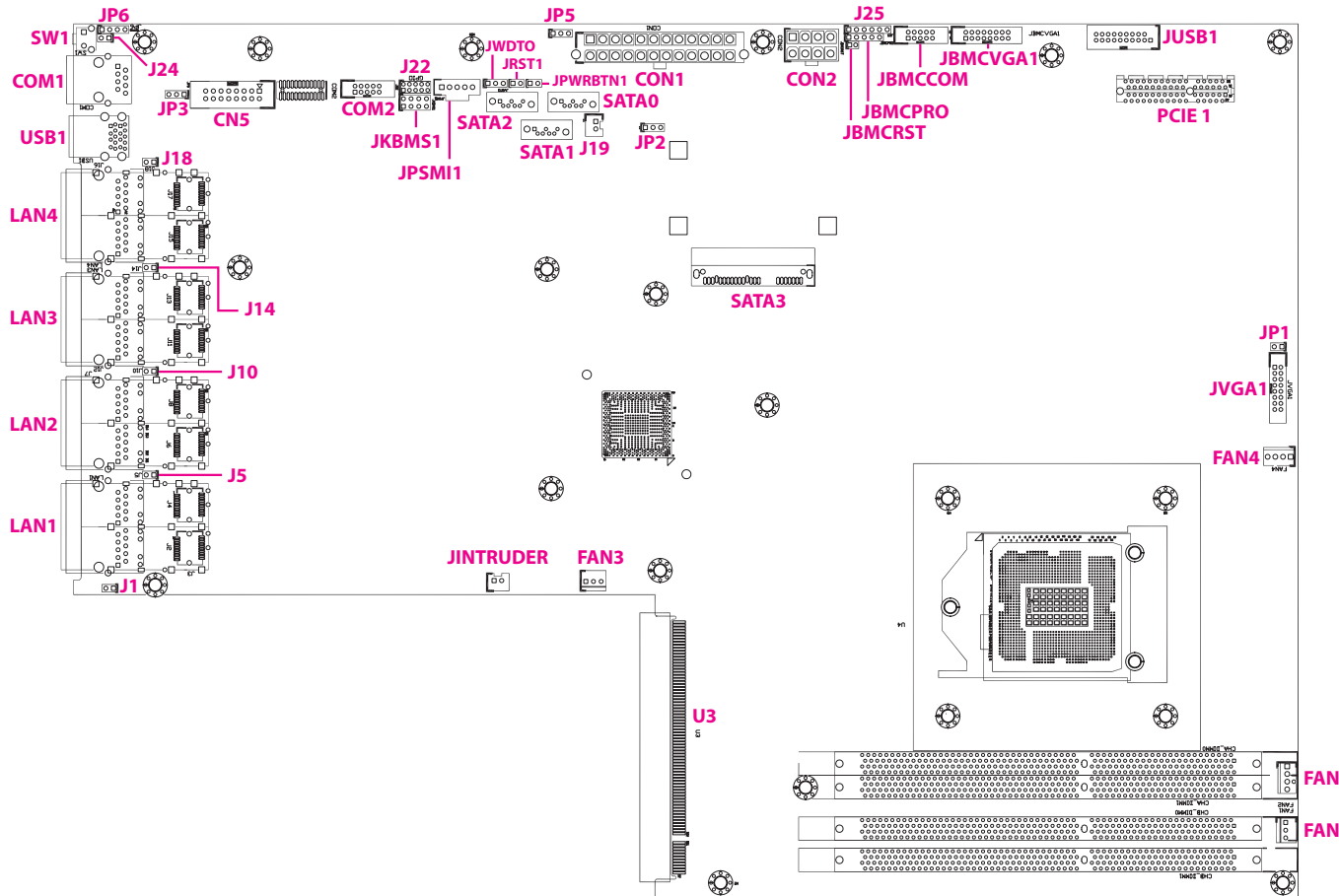

## Jumpers

### RTC Clear

Connector type: 1x3 3-pin header, 2.54mm pitch

Connector location: JP2



Pin	Function
1-2	Normal
2-3	Clear CMOS

Pin	Definition
1	VCCRTC
2	RTC_RST#
3	GND

### ATX/AT Select

Connector type: 1x3 3-pin header, 2.54mm pitch

Connector location: JP5



Pin	Function
1-2	ATX Mode
2-3	AT Mode

Pin	Definition
1	NC
2	AT_ATX_SELECT
3	GND

## Console Pin Header

Connector type: 1x3 3-pin header, 2.54mm pitch

Connector location: JP3



Pin	Function
1-2	RTS to CTS
2-3	Normal

Pin	Description
1	SP_RTS1_R
2	SP_CTS1_R
3	SP_CTS1_CON

## WDTO Pin Header

Connector type: 1x3 3-pin header, 2.54mm pitch

Connector location: JWDTO



Pin	Function
1-2	NMI at WDTO
2-3	Reset at WDTO

Pin	Description
1	NMI_WDTO
2	SIO_WDTO
3	RST_WDTO

## Connector Pin Definitions

### External I/O Interfaces

#### Reset Button

Connector location: SW1

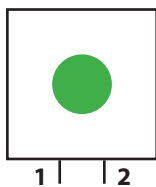

Pin	Definition
1	GND
2	SW_BTN_IN

#### RS232 Console Port

Connector type: RJ45 port

Connector location: COM1

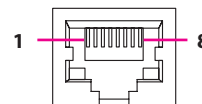

Pin	Definition	Pin	Definition
1	SP_RTS1_R	2	SP_DTR1_R
3	SP_TXD1_R	4	GND
5	SP_DCD1_R	6	SP_RXD1_R
7	SP_DSR1_R	8	SP_CTS1_CON



## Dual USB 3.0 Ports

Connector type: Dual USB 3.0 ports

Connector location: USB1

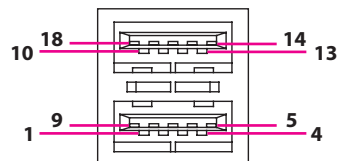

Pin	Definition	Pin	Definition
1	5VDUAL	2	USB2-
3	USB2+	4	GND
5	USB3_RX3-	6	USB3_RX3+
7	GND	8	USB3_TX3-
9	USB3_TX3+	10	5VDUAL
11	USB3-	12	USB3+
13	GND	14	USB3_RX4-
15	USB3_RX4+	16	GND
17	USB3_TX4-	18	USB3_TX4+

## LAN Ports

Connector type: RJ45 with LEDs

Connector location: LAN1, LAN2, LAN3 and LAN4

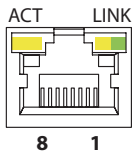

Act	Status
Flashing Yellow	Data activity
Off	No activity

Link	Status
Steady Green	1G network link
Steady Yellow	100Mbps network link
Off	No link

### LAN1

Pin	Definition	Pin	Definition
A1	PORT7_MDI0P	A2	PORT7_MDI0N
A3	PORT7_MDI1P	A4	PORT7_MDI1N
A5	LAN7_RJ_TC	A6	GND
A7	PORT7_MDI2P	A8	PORT7_MDI2N
A9	PORT7_MDI3P	A10	PORT7_MDI3N
A11	PORT7_L1000_N	A12	PORT7_L100_N
A13	PORT7_ACT_N	A14	PORT7_LINK_N
B1	PORT8_MDI0P	B2	PORT8_MDI0N
B3	PORT8_MDI1P	B4	PORT8_MDI1N
B5	LAN8_RJ_TC	B6	GND
B7	PORT8_MDI2P	B8	PORT8_MDI2N
B9	PORT8_MDI3P	B10	PORT8_MDI3N
B11	PORT8_L1000_N	B12	PORT8_L100_N
B13	PORT8_ACT_N	B14	PORT8_LINK_N

### LAN2

Pin	Definition	Pin	Definition
A1	PORT5_MDI0P	A2	PORT5_MDI0N
A3	PORT5_MDI1P	A4	PORT5_MDI1N
A5	LAN5_RJ_TC	A6	GND
A7	PORT5_MDI2P	A8	PORT5_MDI2N
A9	PORT5_MDI3P	A10	PORT5_MDI3N
A11	PORT5_L1000_N	A12	PORT5_L100_N
A13	PORT5_ACT_N	A14	PORT5_LINK_N
B1	PORT6_MDI0P	B2	PORT6_MDI0N
B3	PORT6_MDI1P	B4	PORT6_MDI1N
B5	LAN6_RJ_TC	B6	GND
B7	PORT6_MDI2P	B8	PORT6_MDI2N
B9	PORT6_MDI3P	B10	PORT6_MDI3N
B11	PORT6_L1000_N	B12	PORT6_L100_N
B13	PORT6_ACT_N	B14	PORT6_LINK_N

## LAN3

Pin	Definition	Pin	Definition
A1	PORT3_MDI0P	A2	PORT3_MDI0N
A3	PORT3_MDI1P	A4	PORT3_MDI1N
A5	LAN3_RJ_TC	A6	GND
A7	PORT3_MDI2P	A8	PORT3_MDI2N
A9	PORT3_MDI3P	A10	PORT3_MDI3N
A11	PORT3_L1000_N	A12	PORT3_L100_N
A13	PORT3_ACT_N	A14	PORT3_LINK_N
B1	PORT4_MDI0P	B2	PORT4_MDI0N
B3	PORT4_MDI1P	B4	PORT4_MDI1N
B5	LAN4_RJ_TC	B6	GND
B7	PORT4_MDI2P	B8	PORT4_MDI2N
B9	PORT4_MDI3P	B10	PORT4_MDI3N
B11	PORT4_L1000_N	B12	PORT4_L100_N
B13	PORT4_ACT_N	B14	PORT4_LINK_N

## LAN4

Pin	Definition	Pin	Definition
A1	PORT1_MDI0P	A2	PORT1_MDI0N
A3	PORT1_MDI1P	A4	PORT1_MDI1N
A5	LAN1_RJ_TC	A6	GND
A7	PORT1_MDI2P	A8	PORT1_MDI2N
A9	PORT1_MDI3P	A10	PORT1_MDI3N
A11	PORT1_L1000_N	A12	PORT1_L100_N
A13	PORT1_ACT_N	A14	PORT1_LINK_N
B1	PORT2_MDI0P	B2	PORT2_MDI0N
B3	PORT2_MDI1P	B4	PORT2_MDI1N
B5	LAN2_RJ_TC	B6	GND
B7	PORT2_MDI2P	B8	PORT2_MDI2N
B9	PORT2_MDI3P	B10	PORT2_MDI3N
B11	PORT2_L1000_N	B12	PORT2_L100_N
B13	PORT2_ACT_N	B14	PORT2_LINK_N

## Connector Pin Definitions

### Internal Connectors

#### Digital IO (4 Input/4 Output)

Connector type: 2x5 10-pin header, 2.0mm pitch

Connector location: J22

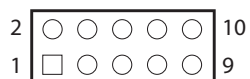

Pin	Definition	Pin	Definition
1	VCC5	2	GND
3	SIO_GP32	4	SIO_GP06
5	SIO_GP03	6	SIO_GP07
7	SIO_GP04	8	SIO_GP76
9	SIO_GP05	10	SIO_GP77

#### COM 2 Box Header Connector (RS232)

Connector type: 2x5 10-pin header, 2.0mm pitch

Connector location: COM2

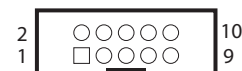

Pin	Definition	Pin	Definition
1	SP_DCD2	2	SP_RXD2
3	SP_TXD2	4	SP_DTR2
5	GND	6	SP_DSR2
7	SP_RTS2	8	SP_CTS2
9	SP_RI2	10	GND

### BMC COM

Connector type: 2x5 10-pin header, 2.0mm pitch

Connector location: JBMCCOM

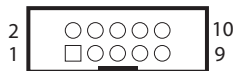

Pin	Definition	Pin	Definition
1	NC	2	SP_RXD
3	SP_TXD	4	NC
5	GND	6	NC
7	NC	8	NC
9	NC	10	GND

### USB2 Box Header

Connector type: 2x10 20-pin header, 2.0mm pitch

Connector location: JUSB1



Pin	Definition	Pin	Definition
1	5VDUAL	2	USB3_RX1-
3	USB3_RX1+	4	GND
5	USB3_TX1-	6	USB3_TX1+
7	GND	8	USB_0-
9	USB_0+	10	NC
11	USB_1+	12	USB_1-
13	GND	14	USB3_TX2+
15	USB3_TX2-	16	GND
17	USB3_RX2+	18	USB3_RX2-
19	5VDUAL	20	

## HW Reset Pin Header

Connector type: 1x2 2-pin header, 2.54mm pitch

Connector location: JRST1



Pin	Definition
1	PCH_SYS_RESET_N_R
2	GND

## Power Button Pin Header

Connector type: 1x2 2-pin header, 2.54mm pitch

Connector location: JPWRBTN1



Pin	Definition
1	GND
2	FP_PWRBTN_N

## NMI Pin Header

Connector type: 1x2 2-pin header, 2.54mm pitch

Connector location: JP1



Pin	Definition
1	NMI_SW-
2	GND

## Bypass LED Pin Header

Connector type: 1x2 2-pin header, 2.54mm pitch

Connector location: J1, J5, J10 and J14



### J1

Pin	Definition
1	VCC3
2	BYPASS_LED_S4

### J5

Pin	Definition
1	VCC3
2	BYPASS_LED_S3

### J10

Pin	Definition
1	VCC3
2	BYPASS_LED_S2

### J14

Pin	Definition
1	VCC3
2	BYPASS_LED_S1

## Power LED Pin Header

Connector type: 1x2 2-pin header, 2.54mm pitch

Connector location: J24



Pin	Definition
1	VCC3
2	POWER_LED

## HDD LED Pin Header

Connector type: 1x2 2-pin header, 2.54mm pitch

Connector location: J18



Pin	Definition
1	VCC3
2	HDD_LED



## GAL Programming Connector

Connector type: 1x6 6-pin header, 2.54mm pitch

Connector location: J25



Pin	Definition	Pin	Definition
1	3VSB	2	GND
3	GAL_TCK	4	GAL_TDO
5	GAL_TDI	6	GAL_TMS

## BMC Programming Connector

Connector type: 1x5 5-pin header, 2.54mm pitch

Connector location: JBMCPRO



Pin	Definition	Pin	Definition
1	FLA_CS0	2	FLA_D0
3	FLA_D1	4	FLA_D2
5	FLA_D3	6	

## BMC Reset Pin Header

Connector type: 1x2 2-pin header, 2.54mm pitch

Connector location: JBMCRST



Pin	Definition
1	BMC_RESET_N
2	GND

## System Fan Connector (4-Pin)

Connector type: 1x4 4-pin Wafer, 2.54mm pitch

Connector location: FAN2 and FAN4

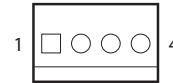

Pin	Definition
1	GND
2	VCC 12
3	Sense
4	FANPWM

## System Fan Connectors (3-Pin)

Connector type: 1x3 3-pin Wafer, 2.54mm pitch

Connector location: FAN1 and FAN3

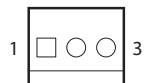

Pin	Definition
1	GND
2	VCC12
3	Sense

## Intrusion Detect Connector

Connector type: 1x2 2-pin header, 2.5mm pitch

Connector location: JINTRUDER



Pin	Definition
1	INTRUDER_N
2	GND

## Internal MO-297 Connector

Connector type: MO-297

Connector location: SATA3

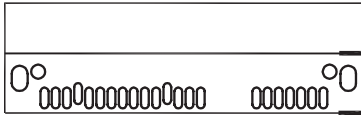

Pin	Definition	Pin	Definition
1	GND	2	SATA_TXP3
3	SATA_TXN3	4	GND
5	SATA_RXN3	6	SATA_RXP3
7	GND	8	NC
9	NC	10	NC
11	GND	12	GND
13	GND	14	VCC5
15	VCC5	16	VCC5
17	GND	18	NC
19	GND	20	NC
21	NC	22	NC

## SATA Connectors

Connector type: Standard Serial ATA, 1.27mm pitch

Connector location: SATA0, SATA1 and SATA2

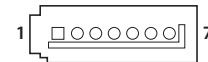

### SATA0

Pin	Definition	Pin	Definition
1	GND	2	SATA_TX0P
3	SATA_TX0N	4	GND
5	SATA_RX0N	6	SATA_RX0P
7	GND		

### SATA1

Pin	Definition	Pin	Definition
1	GND	2	SATA_TX1P
3	SATA_TX1N	4	GND
5	SATA_RX1N	6	SATA_RX1P
7	GND		

### SATA2

Pin	Definition	Pin	Definition
1	GND	2	SATA_TX2P
3	SATA_TX2N	4	GND
5	SATA_RX2N	6	SATA_RX2P
7	GND		

## SATA DOM Power Port

Connector type: 1x2 2-pin header, 2.5mm pitch

Connector location: J19



Pin	Definition
1	VCC5
2	GND

## Keyboard/Mouse Connector

Connector type: 2x4 8-pin header, 2.54mm pitch

Connector location: JKBMS1

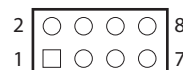

Pin	Definition	Pin	Definition
1	VCC5	2	VCC5
3	KDAT	4	MDAT
5	KCLK	6	MCLK
7	GND	8	GND

## VGA Connector

Connector type: 2x8 16-pin header, 2.0mm pitch

Connector location: JVGA1

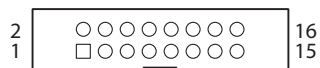

Pin	Definition	Pin	Definition
1	RED_VGA	2	GREEN_VGA
3	BLUE_VGA	4	NC
5	GND	6	GND
7	GND	8	GND
9	VGA_+5V	10	GND
11	NC	12	DDC_DATA_VGA
13	HSYNC_VGA	14	VSYNC_VGA
15	DDC_CLK_VGA	16	NC

## VGA Connector

Connector type: 2x8 16-pin header, 2.0mm pitch

Connector location: JBMCVGA1

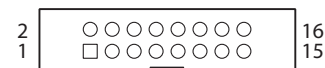

Pin	Definition	Pin	Definition
1	DACROA	2	DACGOA
3	DACBOA	4	NC
5	GND	6	GND
7	GND	8	GND
9	VGA_VCC	10	GND
11	NC	12	DDC_DATAO
13	AHSYNCO	14	AVSYNCO
15	DDC_CLKO	16	NC

## Parallel Interface for LCM Module

Connector type: 2x8 16-pin header, 2.54mm pitch

Connector location: CN5

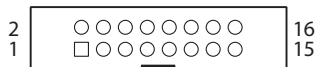

Pin	Definition	Pin	Definition
1	VCC5	2	GND
3	LPT_SLIN#R	4	LPT_RES
5	LPT_AFD#R	6	LPT_INIT#R
7	LPT_PDR1	8	LPT_PDR0
9	LPT_PDR3	10	LPT_PDR2
11	LPT_PDR5	12	LPT_PDR4
13	LPT_PDR7	14	LPT_PDR6
15	LPT_PW	16	VCC5

## Keypad Pin Header

Connector type: 1x4 4-pin header, 2.54mm pitch

Connector location: JP6



Pin	Definition	Pin	Definition
1	KEY_PIN1	2	KEY_PIN2
3	KEY_PIN3	4	KEY_PIN4

## PSMI Connector

Connector type: 1x5 5-pin header, 2.54mm pitch

Connector location: JPSMI1



Pin	Definition	Pin	Definition
1	PMBUS_CLK	2	PMBUS_DATA
3	PMBUS_ALERT_N	4	GND
5	NC	6	

## Power Connector

Connector type: 2x12 24-pin header, 4.2mm pitch

Connector location: CON1

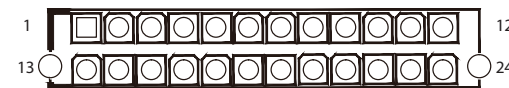

Pin	Definition	Pin	Definition
1	VCC3	2	VCC3
3	GND	4	VCC5
5	GND	6	VCC5
7	GND	8	ATXPWROK
9	5VSB	10	VCC12
11	VCC12	12	VCC3
13	VCC3	14	NVCC12
15	GND	16	SIO_PSON_N
17	GND	18	GND
19	GND	20	GND
21	VCC5	22	VCC5
23	VCC5	24	GND



## Power Connector

Connector type: 2x4 8-pin header, 4.2mm pitch

Connector location: CON2

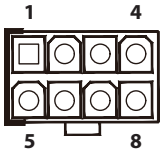

Pin	Definition	Pin	Definition
1	GND	2	GND
3	GND	4	GND
5	VCC12_CPU	6	VCC12_CPU
7	VCC12_CPU	8	VCC12_CPU

## PCIe x4 Slot

Connector type: PCIe x4 Slot

Connector location: PCIE1

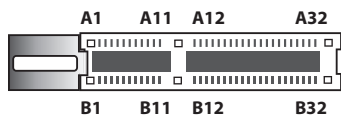

Pin	Definition	Pin	Definition
A1	PRSNT1	B1	VCC12
A2	VCC12	B2	VCC12
A3	VCC12	B3	VCC12
A4	GND	B4	GND
A5	NC	B5	SLOT_SMC
A6	NC	B6	SLOT_SMD
A7	NC	B7	GND
A8	NC	B8	VCC3
A9	VCC3	B9	NC
A10	VCC3	B10	3VSB
A11	RST_X4_SLOT_N	B11	PCIE_WAKE_L
A12	GND	B12	NC
A13	CK_SLOT2_DP	B13	GND
A14	CK_SLOT2_DN	B14	PCH_PE_TXP5
A15	GND	B15	PCH_PE_TXN5
A16	PCH_PE_RXP5	B16	GND

Pin	Definition	Pin	Definition
A17	PCH_PE_RXN5	B17	PRSNT2_1
A18	GND	B18	GND
A19	NC	B19	PCH_PE_TXP6
A20	GND	B20	PCH_PE_TXN6
A21	PCH_PE_RXP6	B21	GND
A22	PCH_PE_RXN6	B22	GND
A23	GND	B23	PCH_PE_TXP7
A24	GND	B24	PCH_PE_TXN7
A25	PCH_PE_RXP7	B25	GND
A26	PCH_PE_RXN7	B26	GND
A27	GND	B27	PCH_PE_TXP8
A28	GND	B28	PCH_PE_TXN8
A29	PCH_PE_RXP8	B29	GND
A30	PCH_PE_RXN8	B30	NC
A31	GND	B31	PRSNT2_2
A32	NC	B32	GND

## LAN Module Slot

Connector location: U3

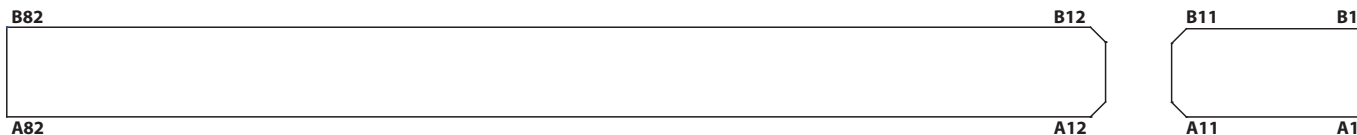

Pin	Definition	Pin	Direction
A1	GND	GND	
A2	LPC_AD0	LPC Multiplexed Command, Address, Data	I/O
A3	LPC_AD1	LPC Multiplexed Command, Address, Data	I/O
A4	LPC_AD2	LPC Multiplexed Command, Address, Data	I/O
A5	LPC_AD3	LPC Multiplexed Command, Address, Data	I/O
A6	LPC_FRAME_N	LPC Frame	O
A7	GND	GND	
A8	CK_33M_PCIE1	33MHz Clock output	O
A9	GNG	GND	
A10	PCIE1_SLOT_RST_N	Platform Reset	O
A11	GND	GND	
A12	P5V	5V	Power
A13	P5V	5V	Power
A14	P5V	5V	Power
A15	P5V	5V	Power
A16	P5V	5V	Power
A17	P3V3	3.3V	Power

Pin	Definition	Pin	Direction
A18	P3V3	3.3V	Power
A19	P3V3	3.3V	Power
A20	P3V3	3.3V	Power
A21	P3V3	3.3V	Power
A22	P3V3	3.3V	Power
A23	P3V3	3.3V	Power
A24	P12V	12V	Power
A25	P12V	12V	Power
A26	P12V	12V	Power
A27	P12V	12V	Power
A28	P12V	12V	Power
A29	ATX_PWROK_B1	Power good signal from ATX power supply 8.2K pull-high to 5VDual	O
A30	ATX_PWROK_B2	Power good signal from ATX power supply 8.2K pull-high to 5VDual	O
A31	GND	GND	
A32	PCIE1_SMBCLK	SMBus Clock. 4.7K pull-high to 3.3V	I/O

Pin	Definition	Pin	Direction
A33	PCIE1_SMBDAT	SMBus Data. 4.7K pull-high to 3.3V	I/O
A34	GND	GND	
A35	FAN_TAC4	Amplitude fan tachometer input	I
A36	GND	GND	
A37	GND	GND	
A38	GND	GND	
A39	GND	GND	
A40	GND	GND	
A41	GND	GND	
A42	GND	GND	
A43	GND	GND	
A44	GND	GND	
A45	HM_VTIN1	Temperature sensor input 10K pull-high to VREF	I
A46	MONITOR_GND	Temperature sensor GND	
A47	GND	GND	
A48	GND	GND	
A49	GND	GND	
A50	GND	GND	
A51	ALL_PWRGD	All power OK signal	O
A52	GND	GND	
A53	N12V	NC	
A54	GND	GND	
A55	GND	GND	
A56	PEG0_RX7P	CPU Primary PCI Express Receive Differential Pair	I
A57	PEG0_RX7N		I

Pin	Definition	Pin	Direction
A58	GND	GND	
A59	PEG0_TX7P	CPU Primary PCI Express Transmit Differential Pair	O
A60	PEG0_TX7N		O
A61	GND	GND	
A62	PEG0_RX6P	CPU Primary PCI Express Receive Differential Pair	I
A63	PEG0_RX6N		I
A64	GND	GND	
A65	PEG0_TX6P	CPU Primary PCI Express Transmit Differential Pair	O
A66	PEG0_TX6N		O
A67	GND	GND	
A68	PEG0_RX5P	CPU Primary PCI Express Receive Differential Pair	I
A69	PEG0_RX5N		I
A70	GND	GND	
A71	PEG0_TX5P	CPU Primary PCI Express Transmit Differential Pair	O
A72	PEG0_TX5N		O
A73	GND	GND	
A74	PEG0_RX4P	CPU Primary PCI Express Receive Differential Pair	I
A75	PEG0_RX4N		I
A76	GND	GND	
A77	PEG0_TX4P	CPU Primary PCI Express Transmit Differential Pair	O
A78	PEG0_TX4N		O
A79	GND	GND	
A80	GND	GND	
A81	GND	GND	
A82	GND	GND	

Pin	Definition	Pin	Direction
B1	GND	GND	
B2	PCIE1_SEL1	High level (3.3VSB) (Identify for module)	O
B3	PCIE1_SEL2	Low level (GND) (Identify for module)	O
B4	PCIE1_SEL3	Low level (GND) (Identify for module)	O
B5	GND	GND	
B6	GND	GND	
B7	GND	GND	
B8	PCIE1_SUSCLK	32KHz Clock output	O
B9	P3V3_DUAL	3.3VSB	Power
B10	P3V3_DUAL	3.3VSB	Power
B11	P3V3_DUAL	3.3VSB	Power
B12	P5V	5V	Power
B13	P5V	5V	Power
B14	P5V	5V	Power
B15	P5V	5V	Power
B16	P5V	5V	Power
B17	P3V3	3.3V	Power
B18	P3V3	3.3V	Power
B19	P3V3	3.3V	Power
B20	P3V3	3.3V	Power
B21	P3V3	3.3V	Power
B22	P3V3	3.3V	Power
B23	P3V3	3.3V	Power
B24	P12V	12V	Power
B25	P12V	12V	Power
B26	P12V	12V	Power
B27	P12V	12V	Power
B28	P12V	12V	Power
B29	SMB_ALERT#	SMBus ALERT#	I
B30	PE_WAKE_N	PCI Express Device Wake Event signal 1K pull-high to 3VDual	I

Pin	Definition	Pin	Direction
B31	ATX_PWROK_A1	Power good signal from ATX power supply 8.2K pull-high to 5VDual	O
B32	ATX_PWROK_A2	Power good signal from ATX power supply 8.2K pull-high to 5VDual	O
B33	GND	GND	
B34	USB_4P	Universal Serial Bus Port Differential signal	I/O
B35	USB_4N	Universal Serial Bus Port Differential signal	I/O
B36	USB_OC45#	USB device Over current Indicators	I
B37	GND	GND	
B38	GND	GND	
B39	GND	GND	
B40	GND	GND	
B41	GND	GND	
B42	GND	GND	
B43	GND	GND	
B44	GND	GND	
B45	GND	GND	
B46	GND	GND	
B47	GND	GND	
B48	GND	GND	
B49	GND	GND	
B50	GND	GND	
B51	GND	GND	
B52	GND	GND	
B53	GND	GND	
B54	GND	GND	
B55	GND	GND	
B56	PEGO_RX3P	CPU Primary PCI Express Receive Differential Pair	I
B57	PEGO_RX3N		I
B58	GND	GND	

Pin	Definition	Pin	Direction
B59	PEG0_TX3P	CPU Primary PCI Express Transmit Differential Pair	O
B60	PEG0_TX3N		O
B61	GND	GND	
B62	PEG0_RX2P	CPU Primary PCI Express Receive Differential Pair	I
B63	PEG0_RX2N		I
B64	GND	GND	
B65	PEG0_TX2P	CPU Primary PCI Express Transmit Differential Pair	O
B66	PEG0_TX2N		O
B67	GND	GND	
B68	PEG0_RX1P	CPU Primary PCI Express Receive Differential Pair	I
B69	PEG0_RX1N		I
B70	GND	GND	
B71	PEG0_TX1P	CPU Primary PCI Express Transmit Differential Pair	O
B72	PEG0_TX1N		O
B73	GND	GND	
B74	PEG0_RX0P	CPU Primary PCI Express Receive Differential Pair	I
B75	PEG0_RX0N		I
B76	GND	GND	
B77	PEG0_TX0P	CPU Primary PCI Express Transmit Differential Pair	O
B78	PEG0_TX0N		O
B79	GND	GND	
B80	CK_SLOT1_DP	Differential PCI Express Clock	O
B81	CK_SLOT1_DN	Differential PCI Express Clock	O
B82	GND	GND	

# Chapter 3: System Setup

## Removing the Chassis Cover



Prior to removing the chassis cover, make sure the unit's power is off and disconnected from the power sources to prevent electric shock or system damage.

1. Remove the screws on the chassis cover then put them in a safe place for later use.

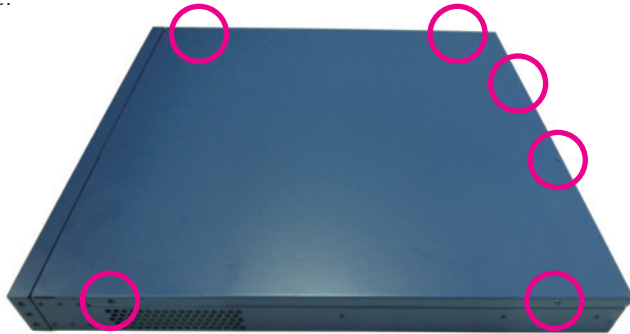

2. Gently slide the cover outwards, then lift up the cover to remove it.

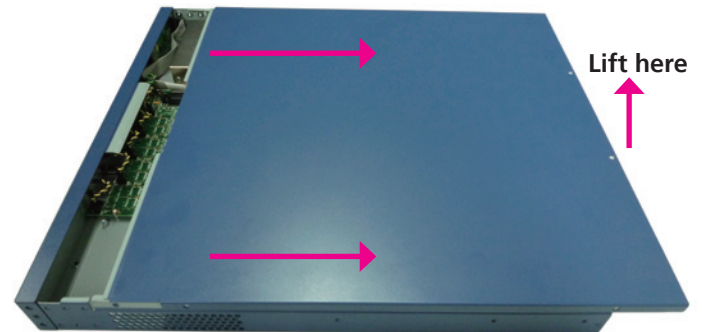

## Installing a SATA DOM

1. Locate the SATA DOM connector on the board.

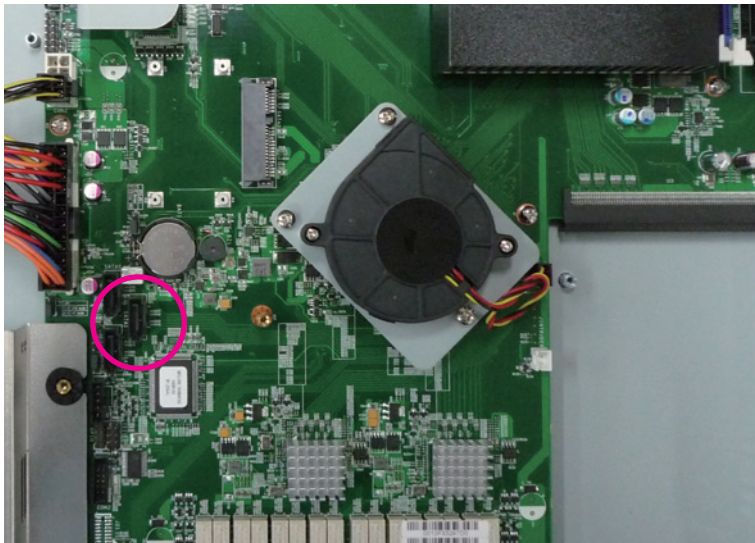

2. Fasten a copper post on the mounting hole.

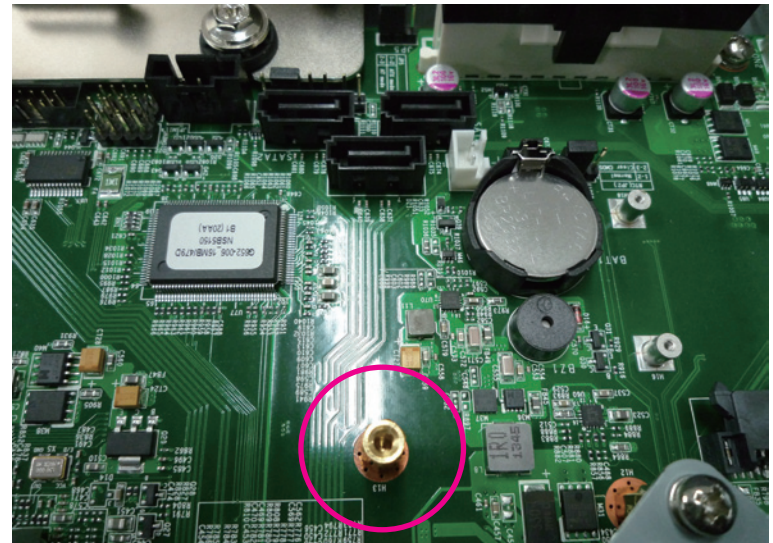



3. Install the SATA DOM to the connector with the mounting hole aligned to the copper post.

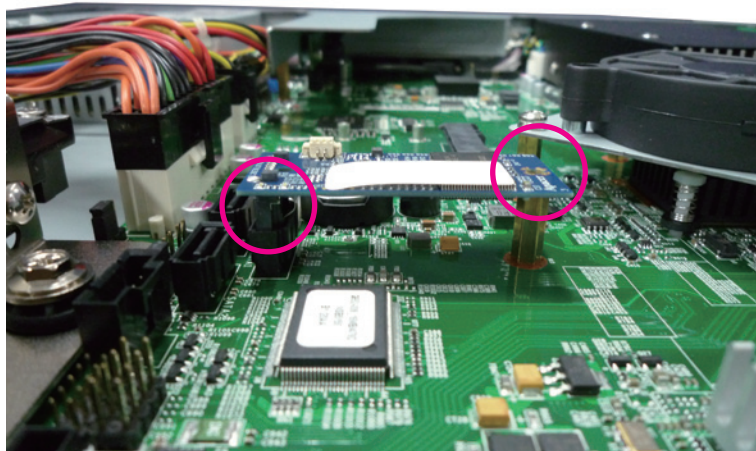

4. Fasten a screw on top of the copper post.

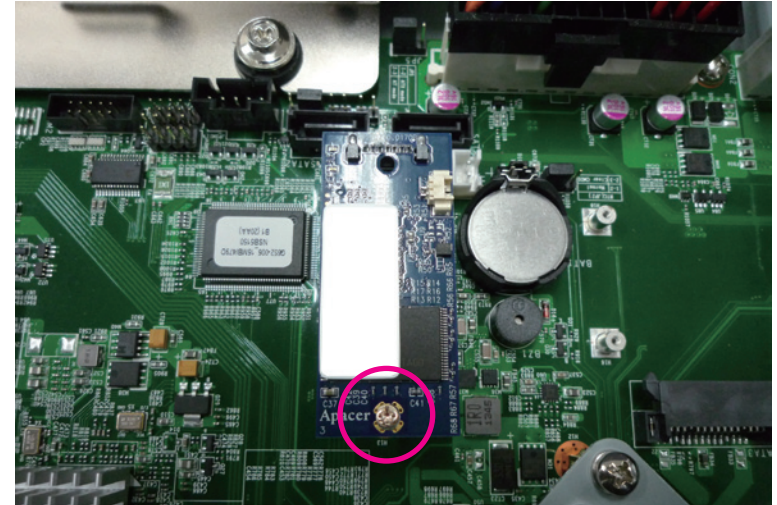

5. Connect the power cable to the power connector on the board.

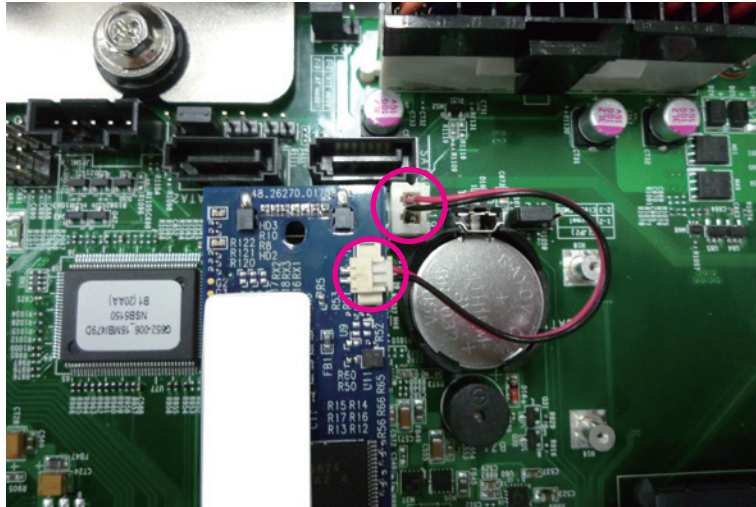

## Installing a MO-297 SSD Module

1. Locate the MO-297 connector on the board.
2. Insert the MO-297 SSD module until it is fully seated into the connector.

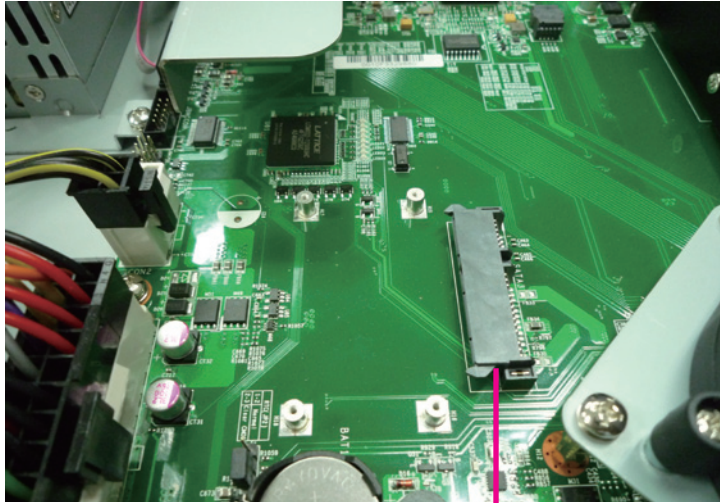

**MO-297  
connector**

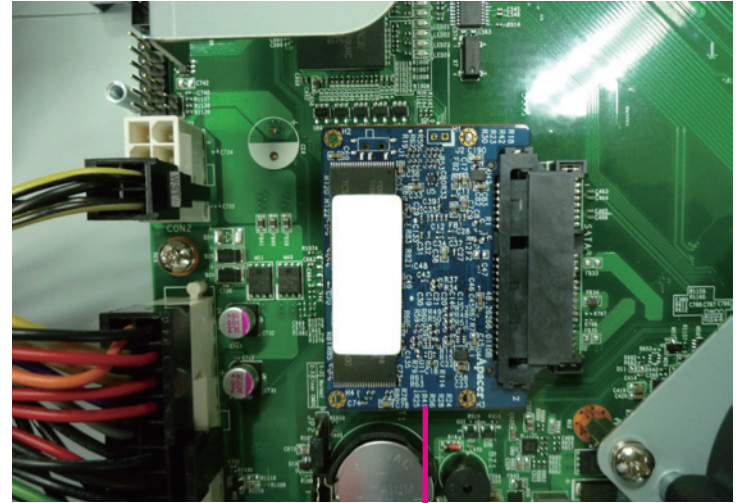

**MO-297  
module**

3. Secure the MO-297 SSD module with screws.

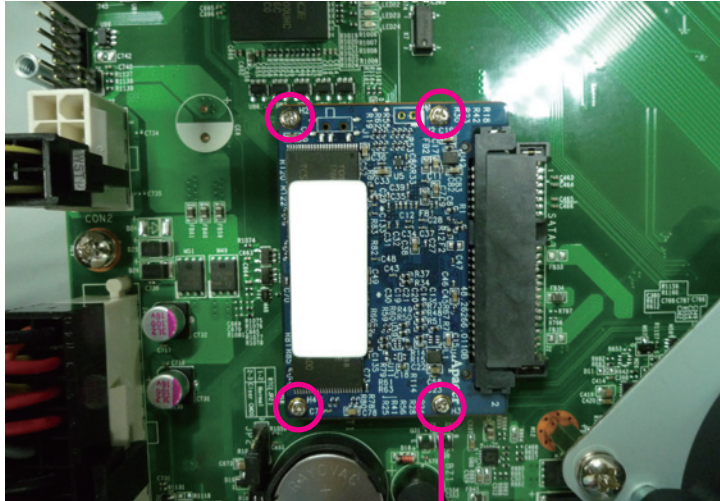

Mounting screw

## Installing a SO DIMM

1. Locate the SO DIMM sockets on the board.

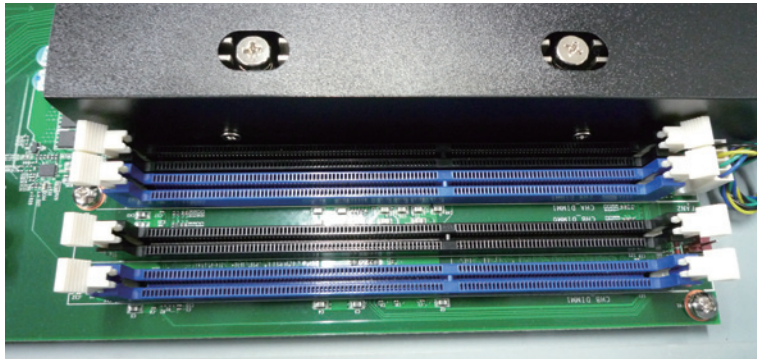

2. Release the locks on the SO DIMM sockets.

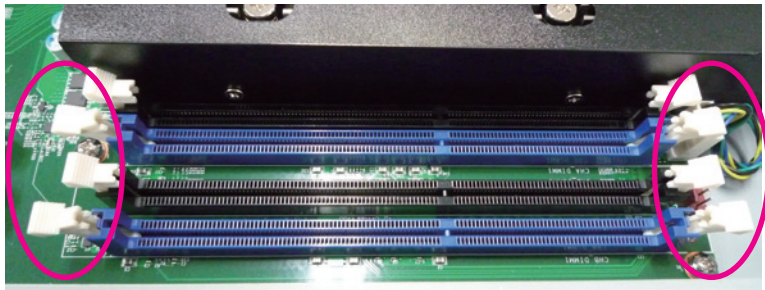

3. Insert the module into the socket at an 90 degree angle. Apply firm even pressure to each end of the module until it slips into the socket.

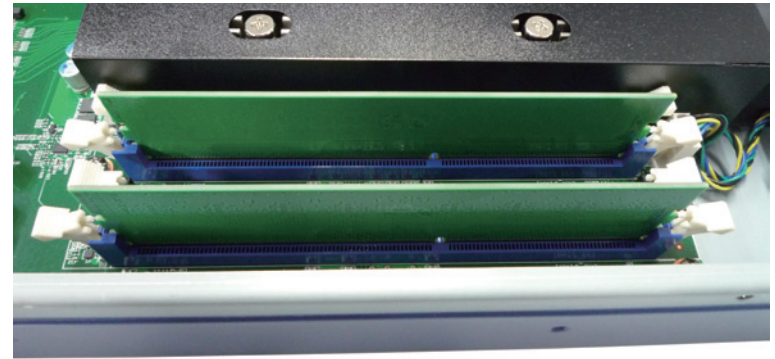

4. While pushing the SO DIMM into the position, the lock will close automatically.

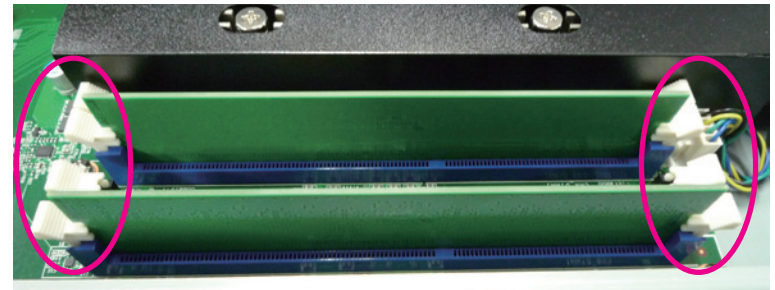

## Installing a 3.5" SATA Hard Drive



Please correctly follow the below instructions and noted items to avoid making unnecessary damages.

1. Remove the mounting screws that secure the hard drive bracket to the chassis.

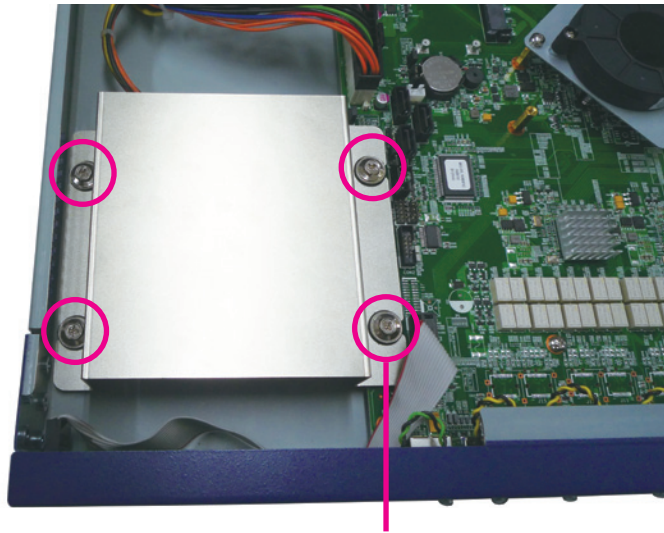

Mounting screw

2. Note the sides of the hard drive bracket. The longer side is designed to fit on the chassis' standoff while the shorter side is designed to fit on the motherboard's standoff.



3. Place the SATA hard drive into the hard drive bracket with the SATA connector facing outwards.



**SATA data and power connector**

4. Align the mounting holes that are on the sides of the SATA drive with the mounting holes on the hard drive bracket. Then use the provided mounting screws to secure the SATA drive in place.



5. Repeat step 4 for securing the screws on the other side of the hard drive bracket.

6. Place the drive into the chassis with the connector side facing the board, and then use the provided mounting screws to secure the hard drive bracket in place.

Connector side



7. Locate the SATA data connector on the board.



SATA data connector



8. Plug the SATA data cable onto the connector, then plug the other end to the SATA data connector on the hard drive.

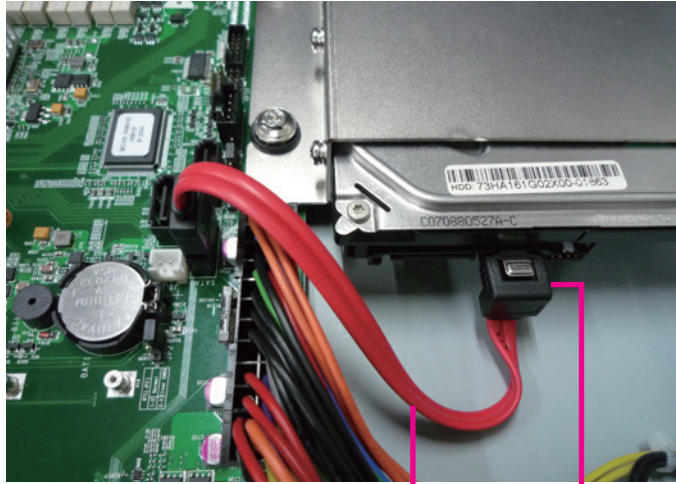

SATA data cable

SATA data connector

9. Plug the SATA power cable to the SATA power connector on the hard drive.

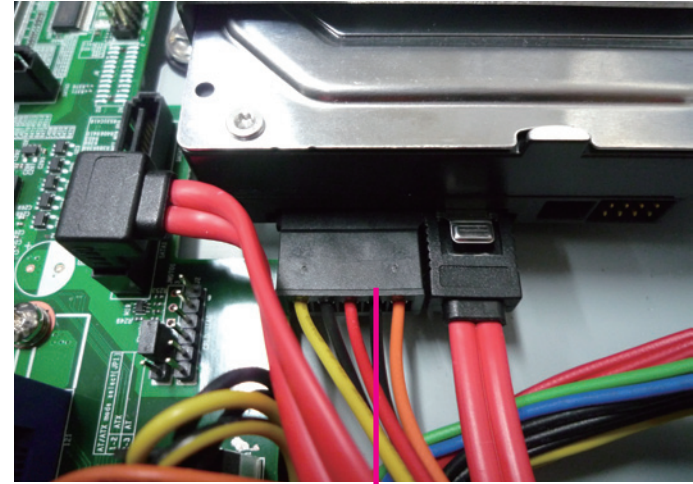

SATA power cable

## Installing a LAN Module

The system is equipped with 1 LAN module bay. To install a LAN module, please follow the instructions below.



Please correctly follow the below instructions and noted items to avoid making unnecessary damages. Make sure the power supply is switched off and disconnected from the power sources before replacing or adding LAN modules to prevent electric shock or system damage.

1. Remove the screw on the cover plate of the LAN module then put them in a safe place for later use.



Mounting screw

Cover plate

2. Place the LAN module into the tray making sure the connector side of the module is facing inwards.

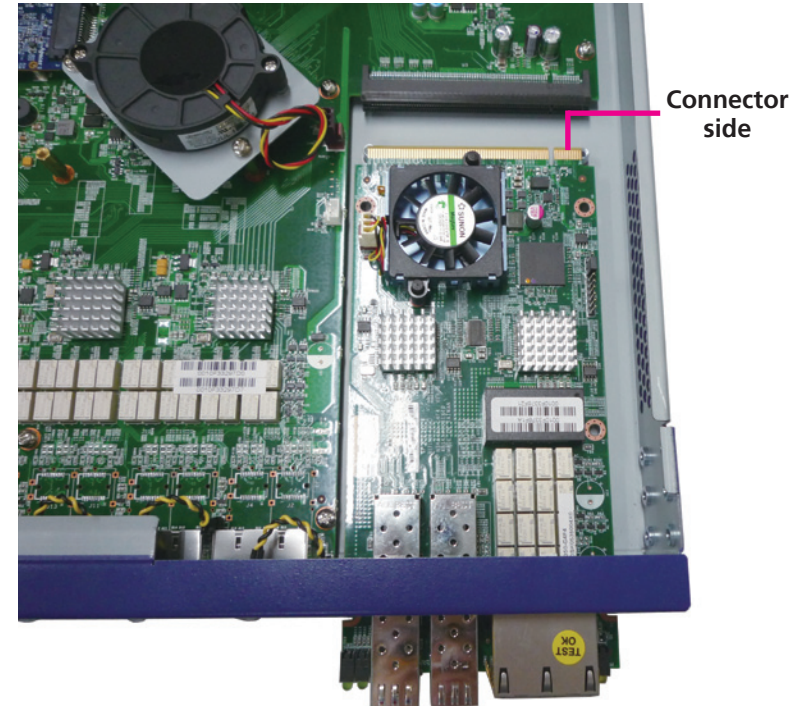

Connector side



The components on the bottom of the LAN module is mounted very close to the base plate of the chassis, you may damage the components if excessive force is used. When installing or removing, please handle the LAN module with care.

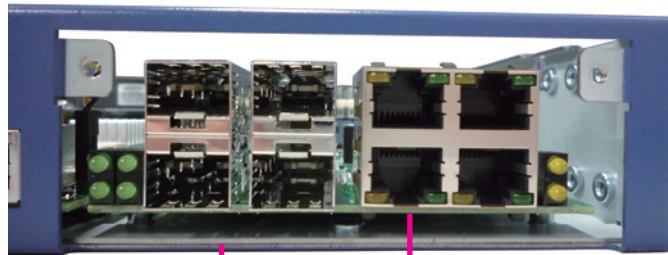

Base plate

Components on bottom

- Once the module is plugged into the LAN module connector, use the provided screws to secure the module in place. Then replace the cover plate and the chassis cover to complete.

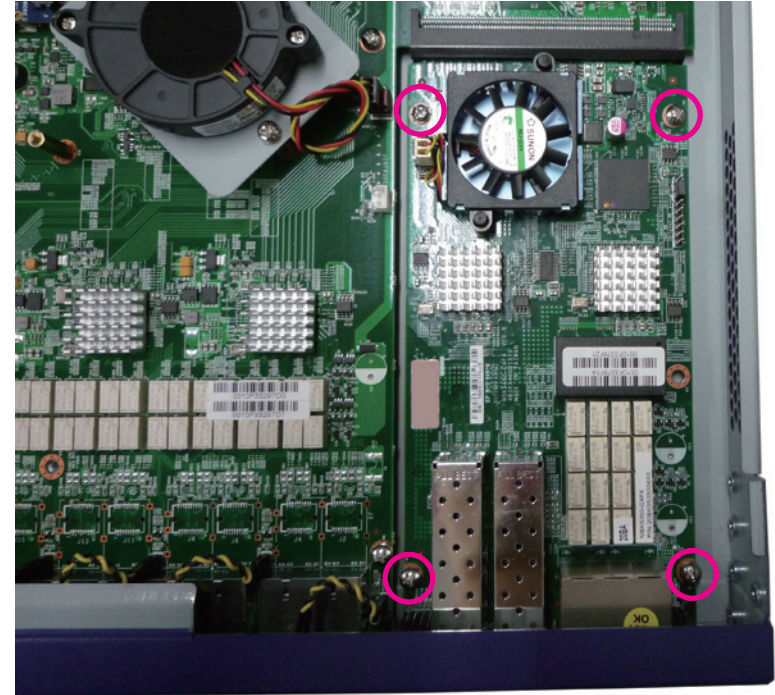

#### Important:



Before using Optical fiber for transferring data, make sure you have connected an approved Optical Transceiver Module. User needs to install appropriate and UL approved Laser Class I Transceivers, rated 3.3Vdc, max. 1W.

# Chapter 4: BIOS Setup

This chapter describes how to use the BIOS setup program for the NSA 5150. The BIOS screens provided in this chapter are for reference only and may change if the BIOS is updated in the future.

To check for the latest updates and revisions, visit the NEXCOM Web site at [www.nexcom.com.tw](http://www.nexcom.com.tw).

## About BIOS Setup

The BIOS (Basic Input and Output System) Setup program is a menu driven utility that enables you to make changes to the system configuration and tailor your system to suit your individual work needs. It is a ROM-based configuration utility that displays the system's configuration status and provides you with a tool to set system parameters.

These parameters are stored in non-volatile battery-backed-up CMOS RAM that saves this information even when the power is turned off. When the system is turned back on, the system is configured with the values found in CMOS.

With easy-to-use pull down menus, you can configure such items as:

- Hard drives, diskette drives, and peripherals
- Video display type and display options
- Password protection from unauthorized use
- Power management features

The settings made in the setup program affect how the computer performs. It is important, therefore, first to try to understand all the setup options, and second, to make settings appropriate for the way you use the computer.

## When to Configure the BIOS

- This program should be executed under the following conditions:
  - When changing the system configuration
  - When a configuration error is detected by the system and you are prompted to make changes to the setup program
  - When resetting the system clock
  - When redefining the communication ports to prevent any conflicts
  - When making changes to the Power Management configuration
  - When changing the password or making other changes to the security setup

Normally, CMOS setup is needed when the system hardware is not consistent with the information contained in the CMOS RAM, whenever the CMOS RAM has lost power, or the system features need to be changed.

## Default Configuration

Most of the configuration settings are either predefined according to the Load Optimal Defaults settings which are stored in the BIOS or are automatically detected and configured without requiring any actions. There are a few settings that you may need to change depending on your system configuration.











## Entering Setup

When the system is powered on, the BIOS will enter the Power-On Self Test (POST) routines. These routines perform various diagnostic checks; if an error is encountered, the error will be reported in one of two different ways:

- If the error occurs before the display device is initialized, a series of beeps will be transmitted.
- If the error occurs after the display device is initialized, the screen will display the error message.

Powering on the computer and immediately pressing  allows you to enter Setup.

## Legends

Key	Function
	Moves the highlight left or right to select a menu.
	Moves the highlight up or down between sub-menu or fields.
	Exits the BIOS Setup Utility.
	Scrolls forward through the values or options of the highlighted field.
	Scrolls backward through the values or options of the highlighted field.
	Selects a field.
	Displays General Help.
	Load previous values.
	Load optimized default values.
	Saves and exits the Setup program.
	Press <Enter> to enter the highlighted sub-menu

## Scroll Bar

When a scroll bar appears to the right of the setup screen, it indicates that there are more available fields not shown on the screen. Use the up and down arrow keys to scroll through all the available fields.

## Submenu

When “▶” appears on the left of a particular field, it indicates that a submenu which contains additional options are available for that field. To display the submenu, move the highlight to that field and press  .

## BIOS Setup Utility

Once you enter the AMI BIOS Setup Utility, the Main Menu will appear on the screen. The main menu allows you to select from several setup functions and one exit. Use arrow keys to select among the items and press  to accept or enter the submenu.

### Main

The Main menu is the first screen that you will see when you enter the BIOS Setup Utility.



### System Date

The date format is <day>, <month>, <date>, <year>. Day displays a day, from Monday to Sunday. Month displays the month, from January to December. Date displays the date, from 1 to 31. Year displays the year, from 1999 to 2099.

### System Time

The time format is <hour>, <minute>, <second>. The time is based on the 24-hour military-time clock. For example, 1 p.m. is 13:00:00. Hour displays hours from 00 to 23. Minute displays minutes from 00 to 59. Second displays seconds from 00 to 59.

### Access Level

Displays the access level of the current user in the BIOS.

## Advanced

The Advanced menu allows you to configure your system for basic operation. Some entries are defaults required by the system board, while others, if enabled, will improve the performance of your system or let you set some features according to your preference.



Setting incorrect field values may cause the system to malfunction.

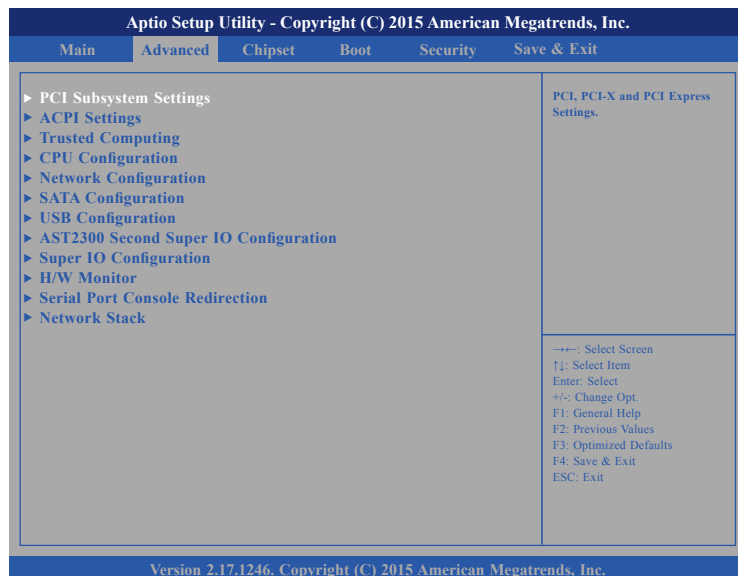



## PCI Subsystem Settings

This section is used to configure the PCI.



### PERR# Generation

Enables or disables the PCI device to generate PERR#.

### SERR# Generation

Enables or disables the PCI device to generate SERR#.

### PCI Latency Timer

This feature is used to select the length of time each PCI device will control the bus before another takes over. The larger the value, the longer the PCI device can retain control of the bus. Since each access to the bus comes with an initial delay before any transaction can be made, low values for the PCI Latency Timer will reduce the effectiveness of the PCI bandwidth while higher values will improve it.

### VGA Palette Snoop

Enables or disables the VGA palette registers snooping.

## ACPI Settings

This section is used to configure ACPI settings.

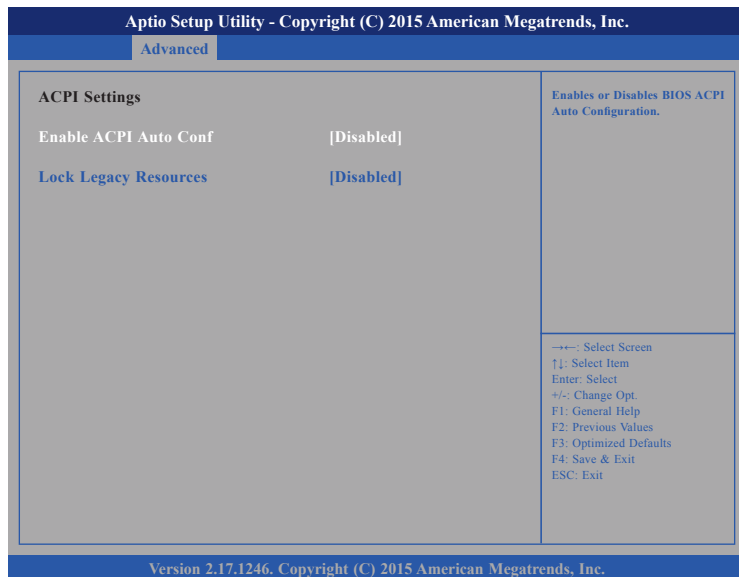

### Enable ACPI Auto Conf

Enables or disables BIOS ACPI auto configuration.

### Lock Legacy Resources

Enables or disables lock of legacy resources

## Trusted Computing

This section is used to configure Trusted Platform Module (TPM) settings.

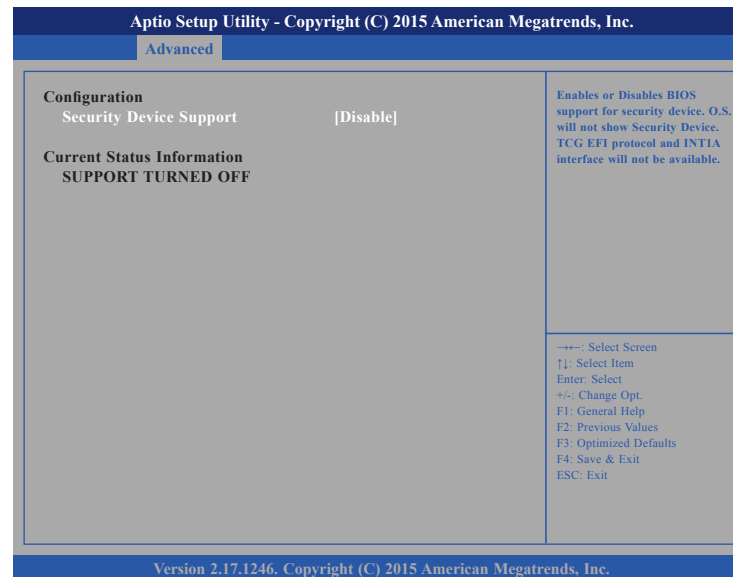

### Security Device Support

Enables or disables BIOS support for security device. O.S will not show Security Device. TCG EFI protocol and INT1A interface will not be available.

## CPU Configuration

This section is used to configure the CPU.

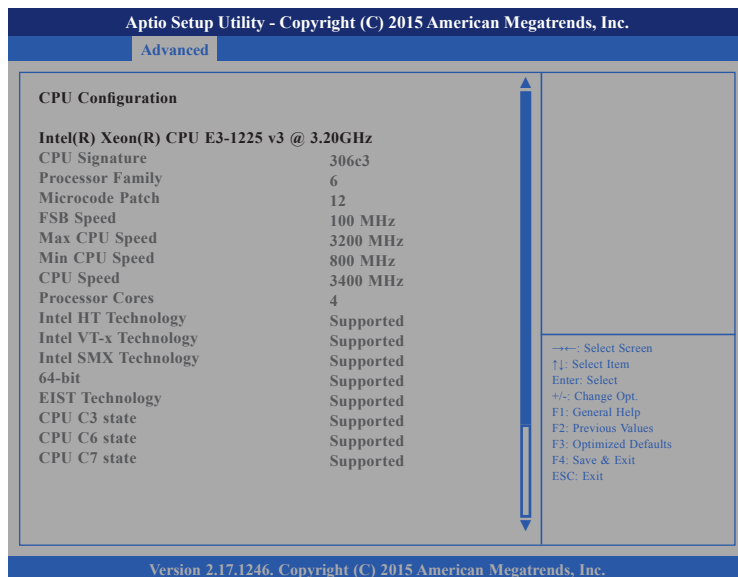

### Hyper-Threading

Enable this field for Windows XP and Linux which are optimized for Hyper-Threading technology. Select disabled for other OSes not optimized for Hyper-Threading technology. When disabled, only one thread per enabled core is enabled.

### Overclocking Lock

Enables or disables overclocking lock.

### Intel® Virtualization

When this field is set to Enabled, the VMM can utilize the additional hardware capabilities provided by Vanderpool Technology.

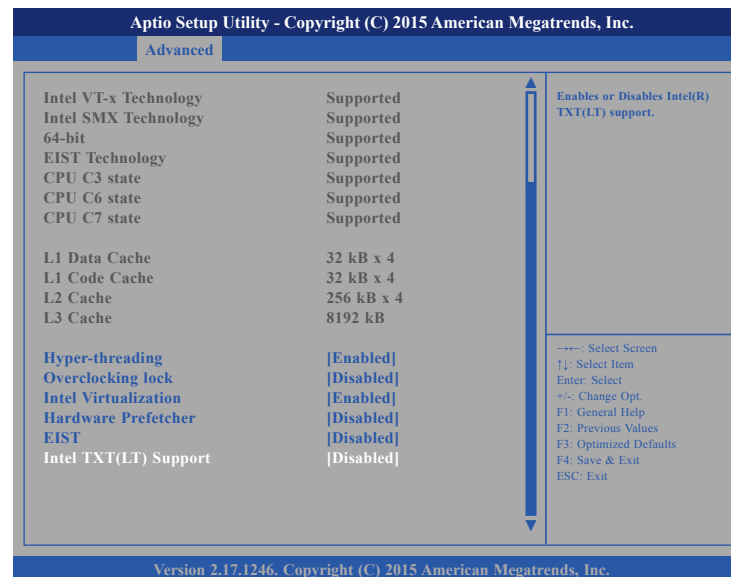

### Hardware Prefetcher

Turns on or off the MLC streamer prefetcher

### EIST

Enables or disables Intel® SpeedStep.

### Intel TXT(LT) Support

Enables or disables Intel TXT(LT).

## Network Configuration

This section is used to configure the network settings.



### Power\_ON ByPass Mode

Enables or disables the LAN module bypass mode after the system powers on.

### Power\_OFF ByPass Mode

Enables or disables the LAN module bypass mode after the system powers off.

## SATA Configuration

This section is used to configure the SATA drives.



### SATA Controller(s)

Enables or disables the SATA controller.

### SATA Mode Selection

Configures the SATA as IDE, AHCI or RAID mode.

- IDE This option configures the Serial ATA drives as Parallel ATA physical storage device.
- AHCI This option configures the Serial ATA drives to use AHCI (Advanced Host Controller Interface). AHCI allows the storage driver to enable the advanced Serial ATA features which will increase storage performance.

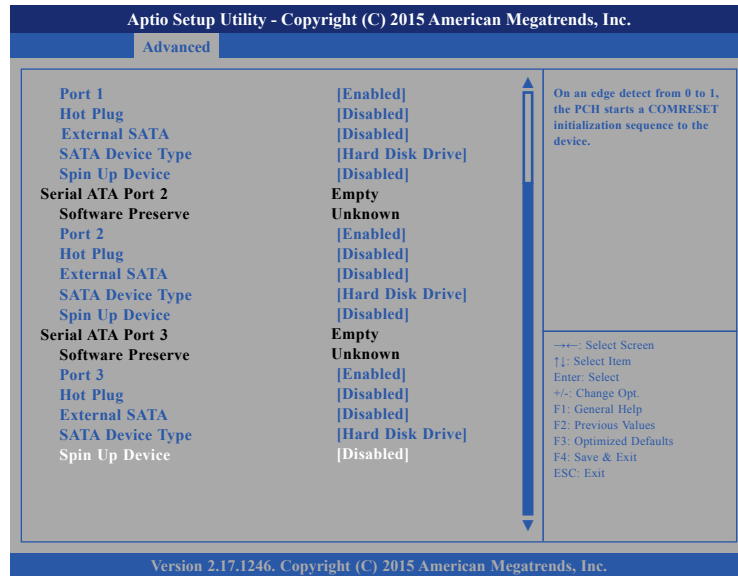

### External SATA

Enables or disables the external SATA option on SATA port 0 to port 3.

### SATA Device Type

The options are Hard Disk Drive and Solid State Drive.

### Spin Up Device

Enables or disables staggered spin up on devices connected to SATA port 0 to port 3.

### SATA Test Mode

Enables or disables SATA test mode.

### Aggressive LPM Support

Enables or disables aggressive LPM support.

### SATA Controller Speed

Configures the SATA controller as Gen1, Gen2 or Gen3.

### Port 0 to Port 3

Enables or disables SATA port 0 to port 3.

### Hot Plug

Enables or disables hot plugging feature on SATA port 0 to port 3.

## USB Configuration

This section is used to configure the USB.

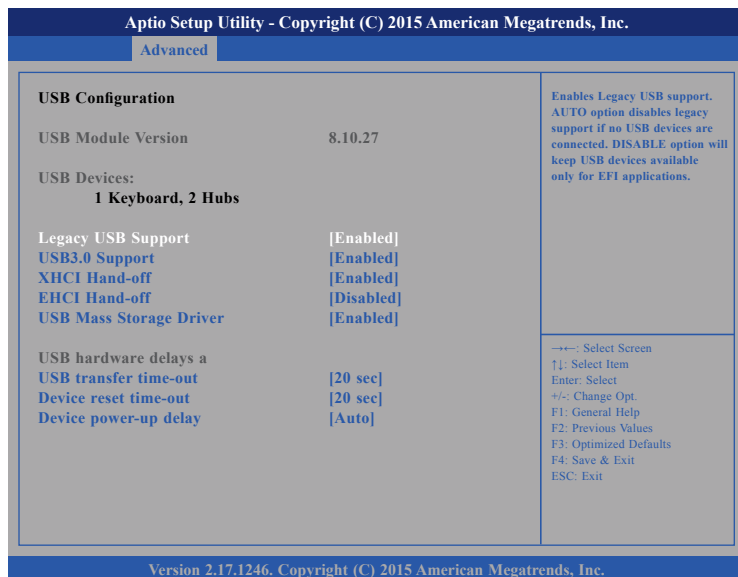

### Legacy USB Support

Enable Enables Legacy USB.

Auto Disables support for Legacy when no USB devices are connected.

Disable Keeps USB devices available only for EFI applications.

### USB3.0 Support

Enables or disables USB 3.0 controller support.

### XHCI Hand-off

This is a workaround for OSs that does not support XHCI hand-off. The XHCI ownership change should be claimed by the XHCI driver.

### EHCI Hand-Off

This is a workaround for OSs that does not support EHCI hand-off. The EHCI ownership change should be claimed by the EHCI driver.

### USB Mass Storage Driver

Enables or disables USB mass storage device driver support.

### USB Transfer Time-out

The time-out value for control, bulk, and Interrupt transfers.

### Device Reset Time-out

Selects the USB mass storage device's start unit command timeout.

### Device Power-up Delay

Maximum time the value will take before it properly reports it self to the Host Controller. "Auto" uses default value: for a Root port it is 100 ms, for a Hub port the delay is taken from Hub descriptor.

## Super IO Configuration

This section is used to configure the I/O functions supported by the onboard Super I/O chip.

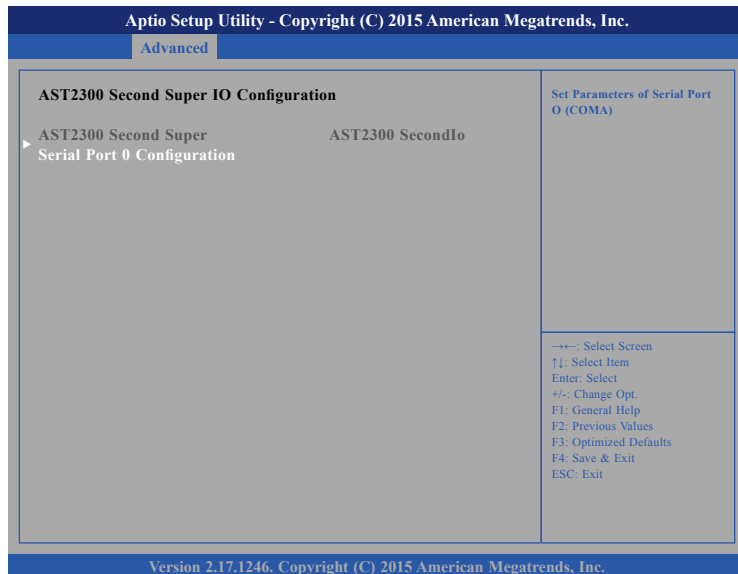

### Super IO Chip

Displays the Super I/O chip used on the board.

### Serial Port 0 Configuration

Configuration settings for serial port 0.

## Super IO Configuration

This section is used to configure the serial ports.



### Super IO Chip

Displays the Super I/O chip used on the board.

### Serial Port 0 Configuration

Configuration settings for serial port 0.

### Serial Port 1 Configuration

Configuration settings for serial port 1.

### Parallel Port Configuration

Configuration settings for parallel port.

## H/W Monitor

This section is used to monitor hardware status such as temperature, fan speed and voltages.

Aptio Setup Utility - Copyright (C) 2015 American Megatrends, Inc.	
Advanced	
<b>PC Health Status</b>	
System Temperature	: +26 C
LAN Module Temperature	: N/A
CPU Temperature	: +26 C
LAN Module Fan Speed	: N/A
Smart FAN1 Speed	: N/A
Smart FAN2 Speed	: 2436 RPM
PCH Fan Speed	: N/A
Fan1 Speed	: N/A
VCORE	: +1.768 V
DRAM Voltage	: +1.512 V
V_1P05_PCH	: +1.039 V
VCC5	: +5.040 V
VCC12	: +12.288 V
AVCC	: +3.296 V
VCC3	: +3.280 V
3VSB	: +3.296 V
VCCRTC	: +3.248 V

→←: Select Screen  
 ↑↓: Select Item  
 Enter: Select  
 +/-: Change Opt.  
 F1: General Help  
 F2: Previous Values  
 F3: Optimized Defaults  
 F4: Save & Exit  
 ESC: Exit

Version 2.17.1246. Copyright (C) 2015 American Megatrends, Inc.

### System Temperature

Detects and displays the current system temperature.

### CPU Temperature

Detects and displays the current CPU temperature.

### LAN Module Fan Speed

Detects and displays the fan speed of the LAN module.

### Smart Fan1 Speed and Smart Fan2 Speed

Detects and displays the fan speed of smart fan1 and smart fan2.

### PCH Fan Speed

Detects and displays the PCH fan speed.

### Fan1 Speed

Detects and displays the Fan1 speed.

### VCORE

Detects and displays the VCore voltage.

### DRAM Voltage

Detects and displays the DRAM voltage.

### V\_1P05\_PCH

Detects and displays the PCH voltage.

### VCC5

Detects and displays 5V voltage.

### VCC12

Detects and displays 12V voltage.

### AVCC

Detects and displays AVCC voltage.

### VCC3

Detects and displays 3.3V voltage.

### 3VSB

Detects and displays 3.3V standby voltage.

### VCCRTC

Detects and displays VCCRTC voltage.



## Serial Port Console Redirection

This section is used to configure the serial port that will be used for console redirection.



### Console Redirection

Enables or disables the console redirection.

## Network Stack

This section is used to configure the network stack.

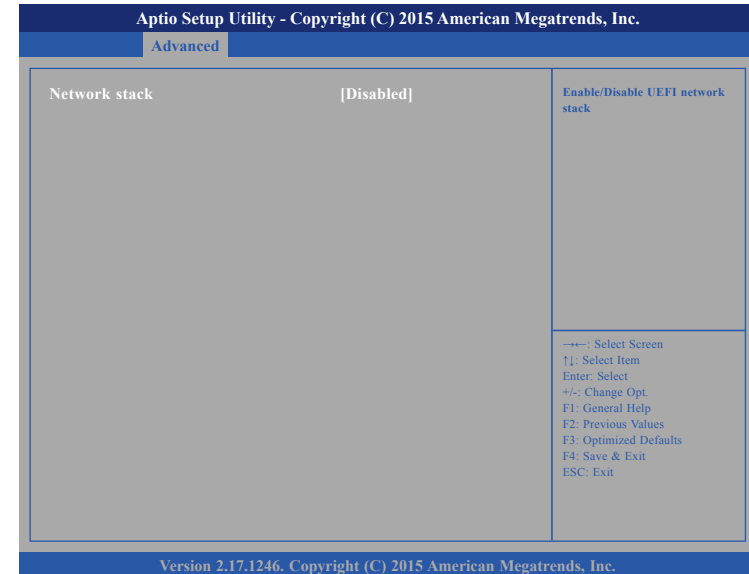

### Network Stack

Enables or disables UEFI network stack.

## Chipset

This section gives you functions to configure the system based on the specific features of the chipset. The chipset manages bus speeds and access to system memory resources.



### PCH-IO Configuration

This field is used to configure PCH parameters.

### System Agent (SA) Configuration

This field is used to configure System Agent (SA) parameters.

## PCH-IO Configuration

This section is used to configure PCH-IO settings.

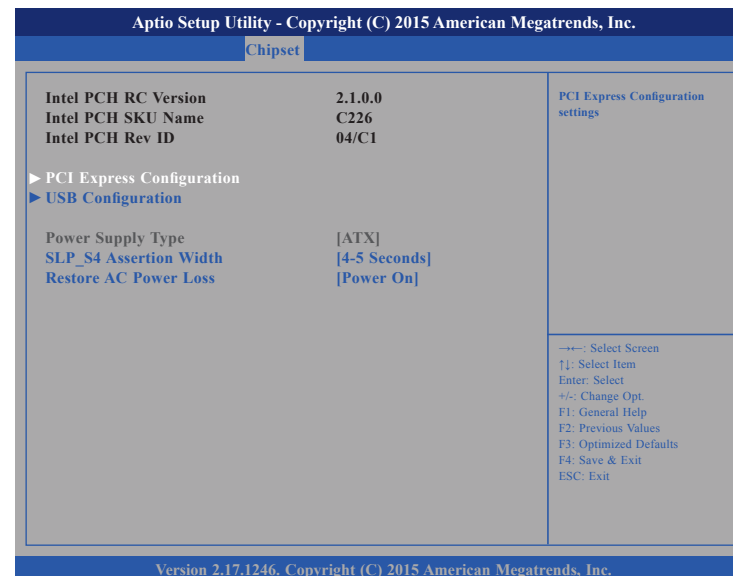

### SLP\_S4 Assertion Width

Select a minimum assertion width of the SLP\_S4# signal.

### Restore AC Power Loss

- |           |  |
|-----------|--|
| Power Off | When power returns after an AC power failure, the system's power is off. You must press the power button to power-on the system. |
| Power On  | When power returns after an AC power failure, the system will automatically power-on.  |

## PCI Express Configuration

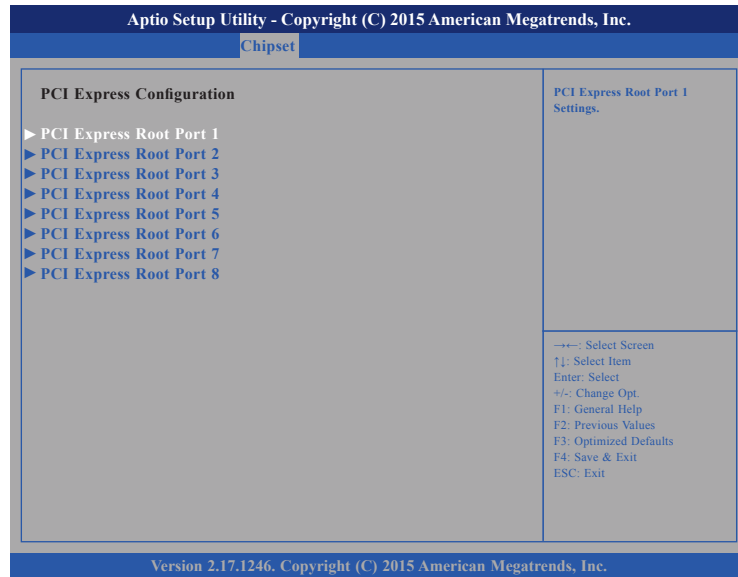

### PCI Express Root Port 1 to PCI Express Root Port 8

Setting menus of PCI Express Root Port 1 to PCI Express Root Port 8.

## PCI Express Root Port 1 to Port 8

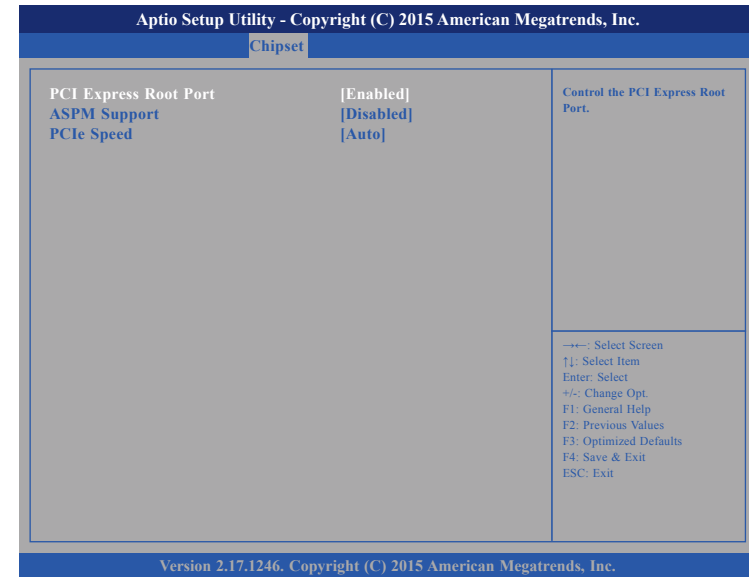

### PCI Express Root Port

Enables or disables the PCI Express port.

### ASPM Support

Selects the ASPM level.

Force L0

Forces all links to L0 state.

Auto

The BIOS automatically selects an ASPM level.

Disable

Disables ASPM.

### PCIe Speed

Configures the speed of the PCI Express Root Port.

## USB Configuration



### USB Precondition

Enables or disables faster USB enumeration.

### XHCI Mode

Enables or disables XHCI mode.

## System Agent (SA) Configuration

This section is used to configure System Agent (SA) settings.

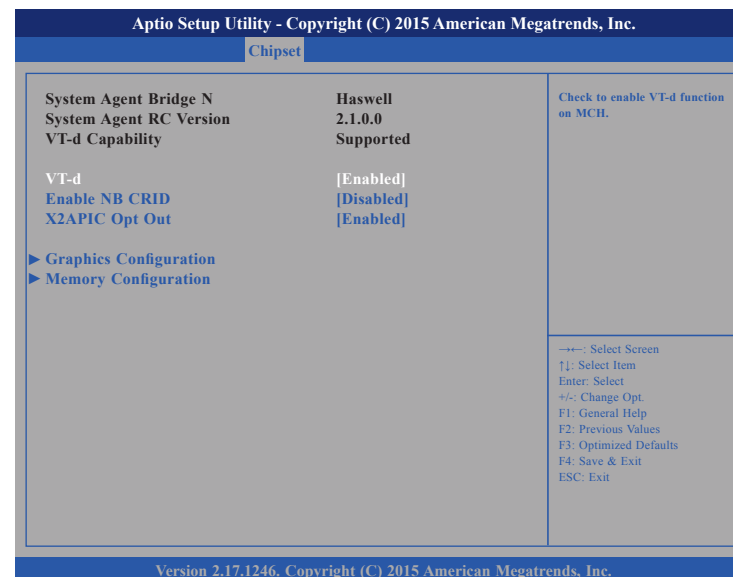

### VT-d

Enables or disables the VT-d.

### Enable NB CRID

Enables or disables NB CRID workaround.

### X2APIC Opt Out

Enables or disables X2APIC mode.

## Graphics Configuration

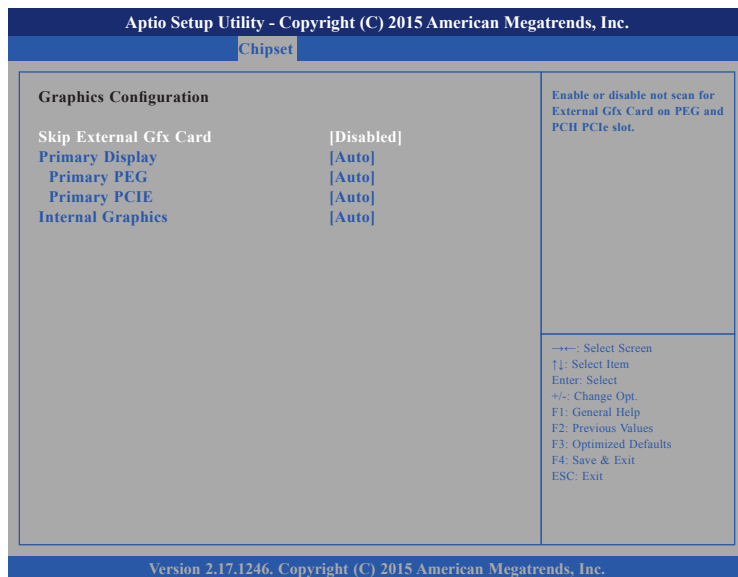

### Skip External Gfx Card

Enables or disables scanning of an external Gfx card on the PEG, PCH and PCIe slot.

### Primary Display

Select which of IGFX/PEG/PCIE graphics device should be the primary display.

### Primary PEG and Primary PCIE

Select which PEG and PCIE should be the primary display.

### Internal Graphics

Keep IGD enabled based on the setup options.

## Memory Configuration

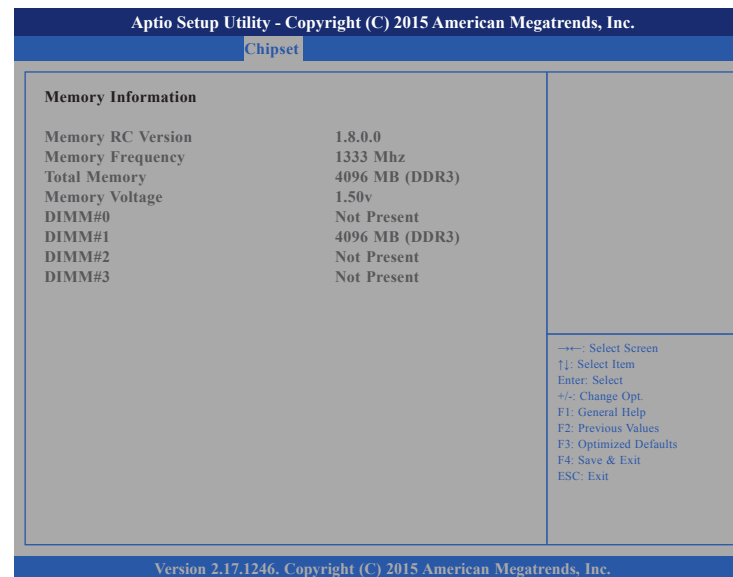

### Memory Information

Detects and displays information of the memory installed in the system.

## Boot

This section is used to configure the boot features.



### Setup Prompt Timeout

Selects the number of seconds to wait for the setup activation key. 65535(0xFFFF) denotes indefinite waiting.

### Bootup NumLock State

This allows you to determine the default state of the numeric keypad. By default, the system boots up with NumLock on wherein the function of the numeric keypad is the number keys. When set to Off, the function of the numeric keypad is the arrow keys.

### Quiet Boot

Enabled                Displays OEM logo instead of the POST messages.  
 Disabled              Displays normal POST messages.

### Fast Boot

When enabled, the BIOS will shorten or skip some check items during POST. This will decrease the time needed to boot the system.

### Boot Mode Select

Configures the boot mode option.

### Fixed Boot Order Priorities

Adjust the boot sequence of the system. Boot Option #1 is the first boot device that the system will boot from, next will be #2 and so forth.

## CSM16 Parameters

Aptio Setup Utility - Copyright (C) 2015 American Megatrends, Inc.		
		Boot
<b>CSM16 Parameters</b>		
CSM16 Module Version	07.71	UPON REQUEST - GA20 can be disabled using BIOS services. ALWAYS - do not allow disabling GA20; this option is useful when any RT code is executed above 1MB.
GateA20 Active	[Upon Request]	
Option ROM Messages	[Force BIOS]	
INT19 Trap Response	[Immediate]	
		←→: Select Screen ↑↓: Select Item Enter: Select +/-: Change Opt. F1: General Help F2: Previous Values F3: Optimized Defaults F4: Save & Exit ESC: Exit
Version 2.17.1246. Copyright (C) 2015 American Megatrends, Inc.		

### GateA20 Active

Upon Request GA20 can be disabled using BIOS services.  
 Always Does not allow disabling GA20. This option is useful when an RT code is executed above 1M.

### Option ROM Messages

Selects the display mode for Option ROM.

### INT19 Trap Response

When enabled, it allows the optional ROM to trap interrupt 19.

## CSM Parameters

Aptio Setup Utility - Copyright (C) 2015 American Megatrends, Inc.		
		Boot
Launch CSM	[Enabled]	This option controls if CSM will be launched
Boot option filter	[Legacy only]	
Launch PXE OpROM policy	[Disabled]	
Launch Storage OpROM policy	[Legacy only]	
Launch Video OpROM policy	[Legacy only]	
Other PCI device ROM	[UEFI OpROM]	
		←→: Select Screen ↑↓: Select Item Enter: Select +/-: Change Opt. F1: General Help F2: Previous Values F3: Optimized Defaults F4: Save & Exit ESC: Exit
Version 2.17.1246. Copyright (C) 2015 American Megatrends, Inc.		

### Launch CSM

This option controls if CSM will be launched.

### Boot Option Filter

This options filters which devices the system can boot to.

### Launch PXE OpROM Policy and Launch Storage OpROM Policy

Enables or disables the boot option for legacy network devices and legacy storage devices.

### Launch Video OpROM Policy

Enables or disables the boot option for legacy video devices.

### Other PCI Device ROM

This options selects whether UEFI mode or Legacy mode will be used when other OpROM is initialized.

## Security

Aptio Setup Utility - Copyright (C) 2015 American Megatrends, Inc.					
Main	Advanced	Chipset	Boot	Security	Save & Exit
<p><b>Password Description</b></p> <p>The password length must be in the following range:</p> <p>Minimum length            3</p> <p>Maximum length            20</p> <p>Administrator Password</p>		<p>Set Administrator Password</p>			
		<p>→←: Select Screen ↑↓: Select Item Enter: Select +/-: Change Opt. F1: General Help F2: Previous Values F3: Optimized Defaults F4: Save &amp; Exit ESC: Exit</p>			
Version 2.17.1246. Copyright (C) 2015 American Megatrends, Inc.					

### Administrator Password

Select this to reconfigure the administrator's password.

## Save & Exit

Aptio Setup Utility - Copyright (C) 2015 American Megatrends, Inc.					
Main	Advanced	Chipset	Boot	Security	Save & Exit
<p>Save Changes and Exit</p> <p>Discard Changes and Exit</p> <p>Save Changes and Reset</p> <p>Discard Changes and Reset</p> <p><b>Save Options</b></p> <p>Save Changes</p> <p>Discard Changes</p> <p>Restore Defaults</p> <p>Save as User Defaults</p> <p>Restore User Defaults</p> <p><b>Boot Override</b></p> <p>Launch EFI Shell from filesystem device</p>		<p>Exit system setup after saving the changes.</p>			
		<p>→←: Select Screen ↑↓: Select Item Enter: Select +/-: Change Opt. F1: General Help F2: Previous Values F3: Optimized Defaults F4: Save &amp; Exit ESC: Exit</p>			
Version 2.17.1246. Copyright (C) 2015 American Megatrends, Inc.					

### Save Changes and Exit

To save the changes and exit the Setup utility, select this field then press <Enter>. A dialog box will appear. Confirm by selecting Yes. You can also press <F4> to save and exit Setup.

### Discard Changes and Exit

To exit the Setup utility without saving the changes, select this field then press <Enter>. You may be prompted to confirm again before exiting. You can also press <ESC> to exit without saving the changes.



### **Save Changes and Reset**

To save the changes and reset, select this field then press <Enter>. A dialog box will appear. Confirm by selecting Yes.

### **Discard Changes and Reset**

To exit the Setup utility without saving the changes, select this field then press <Enter>. You may be prompted to confirm again before exiting.

### **Save Changes**

To save changes and continue configuring the BIOS, select this field then press <Enter>. A dialog box will appear. Confirm by selecting Yes.

### **Discard Changes**

To discard the changes, select this field then press <Enter>. A dialog box will appear. Confirm by selecting Yes to discard all changes made and restore the previously saved settings.

### **Restore Defaults**

To restore the BIOS to default settings, select this field then press <Enter>. A dialog box will appear. Confirm by selecting Yes.

### **Save as User Defaults**

To use the current configurations as user default settings for the BIOS, select this field then press <Enter>. A dialog box will appear. Confirm by selecting Yes.

### **Restore User Defaults**

To restore the BIOS to user default settings, select this field then press <Enter>. A dialog box will appear. Confirm by selecting Yes.

### **Boot Override**

To bypass the boot sequence from the Boot Option List and boot from a particular device, select the desired device and press <Enter>.

### **Launch EFI Shell From Filesystem Device**

Launches the EFI shell.

# Appendix A: Bypass Register

## Register Map

The following tables are the Register Map for NSA 5150.

Bypass Timer Configuration Register							
Offset 0xF2							
7	6	5	4	3	2	1	0
R	X	X	X	X	RW		
Timer Expired	Unused	Unused	Unused	Unused	Global Timeout Value		

Power OFF State Bypass Control Status Register							
Offset 0xF7							
7	6	5	4	3	2	1	0
X	X	X	X	X	X	W	W
Unused	Unused	Unused	Unused	Segment4	Segment3	Segment2	Segment1

Power ON State Bypass Control Status Register							
Offset 0xF3							
7	6	5	4	3	2	1	0
W	X	X	X	X	W	W	
Bypass Mode	Unused	Unused	Segment4	Segment3	Segment2	Segment1	

## Register Bit Definitions

Bypass Timer Configuration Register (F2)		
Bit Field	Name	Value
2:0	Timer Value	000 = 0 second, timer immediately expired 001 = 1 second 010 = 2 second 011 = 4 second 100 = 8 second 101 = 16 second 110 = 32 second 111 = 64 second  Note: This is a write only field. Upon reads these bit values are undefined. A Timer value of 1 to 7 is required to be written before expiration of the hardware timer. When the timer expires, all segments which have been enabled in bits 2:0 of <i>Power ON state Bypass Control Status Register</i> set relays closed to form bypass segments. It is responsibility of software to keep track of time to ensure writes to this register occur no greater than $\text{TimerValueInSeconds} / 2$ . A write of the timer value will automatically reset the expiration timer and set it to the value expressed in bit 2:0 .
3	Not used	No active taken if written, value is undetermined and not needed on read operation.
4	Not used	No active taken if written, value is undetermined and not needed on read operation.
5	Not used	No active taken if written, value is undetermined and not needed on read operation.
6	Not used	No active taken if written, value is undetermined and not needed on read operation.
7	Segment Timer Expired	<b>Read only bit:</b> 0 = Timer has not expired 1 = Timer has expired, de-assert while leave Timer mode

Power ON State Bypass Control Status Register (F3)																	
Bit Field	Name	Value															
1:0	Segment 1 to 2	Segment control bit mask. Each bit corresponds to a specific segment numbered 1 through 2. <b>Write:</b> If a segment mask bit is set to false (0) no action on that segment will take place. If a segment mask bit has been set to true (1), action will take place on this segment according to the bypass mode settings in bits 7:6.															
2	Not used	No active taken if written, value is undetermined and not needed on read operation.															
3	Not used	No active taken if written, value is undetermined and not needed on read operation.															
4	Not used	No active taken if written, value is undetermined and not needed on read operation.															
5	Not used	No active taken if written, value is undetermined and not needed on read operation.															
7:6	Bypass Mode	These two bits defined the bypass mode for one or more segments. These bits are Write only and on reads returns undetermined values which will be ignored by the driver.  Bypass Mode Table: <table border="1" data-bbox="1271 891 1791 1206"> <thead> <tr> <th>Bit 7</th> <th>Bit 6</th> <th>Action</th> </tr> </thead> <tbody> <tr> <td>0</td> <td>0</td> <td>Ignore, no action taken</td> </tr> <tr> <td>0</td> <td>1</td> <td>Force Enable: Engage bypass relays on segments enabled in segment mask.</td> </tr> <tr> <td>1</td> <td>0</td> <td>Force Disable: Disable bypass relays immediately on segments enabled in mask.</td> </tr> <tr> <td>1</td> <td>1</td> <td>Timer Enable: Segments enabled in mask are under Timer control.</td> </tr> </tbody> </table>	Bit 7	Bit 6	Action	0	0	Ignore, no action taken	0	1	Force Enable: Engage bypass relays on segments enabled in segment mask.	1	0	Force Disable: Disable bypass relays immediately on segments enabled in mask.	1	1	Timer Enable: Segments enabled in mask are under Timer control.
Bit 7	Bit 6	Action															
0	0	Ignore, no action taken															
0	1	Force Enable: Engage bypass relays on segments enabled in segment mask.															
1	0	Force Disable: Disable bypass relays immediately on segments enabled in mask.															
1	1	Timer Enable: Segments enabled in mask are under Timer control.															

Power OFF State Bypass Control Status Register (F7)		
Bit Field	Name	Value
0	Segment 1	0 = Set segment bypass disable when power off 1 = Set segment bypass enable when power off
1	Segment 2	0 = Set segment bypass disable when power off 1 = Set segment bypass enable when power off
2	Segment 3	0 = Set segment bypass disable when power off 1 = Set segment bypass enable when power off
3	Segment 4	0 = Set segment bypass disable when power off 1 = Set segment bypass enable when power off
7:4	Unused	No active taken if written, value is undetermined and not needed on read operation.