



NEXCOM International Co., Ltd.

IoT Automation Solutions Business Group

Industrial Fanless Computer

NISE 4300

User Manual

CONTENTS

Preface

Copyright	iv
Disclaimer	iv
Acknowledgements	iv
Regulatory Compliance Statements	iv
Declaration of Conformity	iv
RoHS Compliance	v
Warranty and RMA	vi
Safety Information	viii
Installation Recommendations	viii
Safety Precautions	ix
Technical Support and Assistance	x
Conventions Used in this Manual	x
Global Service Contact Information	xi
Package Contents	xiii
Ordering Information	xiv

Chapter 1: Product Introduction

Overview	1
Key Features	1
Hardware Specifications	2
Knowing Your NISE 4300	4
Front Panel	4
Rear Panel	5
Mechanical Dimensions	6

Chapter 2: Jumpers and Connectors

Before You Begin	7
Precautions	7
Jumper Settings	8
Locations of the Jumpers and Connectors for NISE 4300	9
NISE 4300	9
Top View	9
Bottom View	10
Jumpers	11
LVDS Panel Power Selection	11
Backlight Volume Selection	11
COM1 Port Power Setting	12
COM2 Port Power Setting	12
Connector Pin Definitions	13
External I/O Interfaces - Front Panel	13
DC Power Input	13
LAN1 and LAN2 Ports	13
USB 2.0 Ports	14
USB 3.0 Ports	14
DisplayPort	15
COM1 and COM2 Ports	15
LED Indicators	16
Internal Connectors	17
Debug Connector	17
LED Connector	17



- LVDS Connector 18
- LVDS Connector 18
- LVDS Inverter Connector 19
- Front Panel Connector 19
- Internal USB 2.0 Connector 20
- Touch Screen Connector 20
- Front USB 21
- GPIO Connector 21
- COM3 Connector (RS232/422/485) 22
- SATA Connector (7-pin and 15-pin) 23
- Battery Connector 23
- EC Debug 24
- Fan Connector 24
- BIOS FW 25

- BIOS Setup Utility 40
 - Main 40
 - Advanced 41
 - Chipset 47
 - Security 50
 - Boot 51
 - Save & Exit 52

Chapter 3: System Setup

- Removing the Chassis Bottom Cover 26
- Installing a SO-DIMM Memory Module 27
- Installing an M.2 Storage Module 28
- Installing a Mini-PCIe Storage/Wi-Fi/LTE Module 30
- Installing a Storage Drive 32
- Wall Mounting Instructions 36

Chapter 4: BIOS Setup

- About BIOS Setup 37
- When to Configure the BIOS 37
- Default Configuration 38
- Entering Setup 38
- Legends 38

PREFACE

Copyright

This publication, including all photographs, illustrations and software, is protected under international copyright laws, with all rights reserved. No part of this manual may be reproduced, copied, translated or transmitted in any form or by any means without the prior written consent from NEXCOM International Co., Ltd.

Disclaimer

The information in this document is subject to change without prior notice and does not represent commitment from NEXCOM International Co., Ltd. However, users may update their knowledge of any product in use by constantly checking its manual posted on our website: <http://www.nexcom.com>. NEXCOM shall not be liable for direct, indirect, special, incidental, or consequential damages arising out of the use of any product, nor for any infringements upon the rights of third parties, which may result from such use. Any implied warranties of merchantability or fitness for any particular purpose is also disclaimed.

Acknowledgements

NISE 4300 is a trademark of NEXCOM International Co., Ltd. All other product names mentioned herein are registered trademarks of their respective owners.

Regulatory Compliance Statements

This section provides the FCC compliance statement for Class A devices and describes how to keep the system CE compliant.

Declaration of Conformity

FCC

This equipment has been tested and verified to comply with the limits for a Class A digital device, pursuant to Part 15 of FCC Rules. These limits are designed to provide reasonable protection against harmful interference when the equipment is operated in a commercial environment. This equipment generates, uses, and can radiate radio frequency energy and, if not installed and used in accordance with the instructions, may cause harmful interference to radio communications. Operation of this equipment in a residential area (domestic environment) is likely to cause harmful interference, in which case the user will be required to correct the interference (take adequate measures) at their own expense.

CE

The product(s) described in this manual complies with all applicable European Union (CE) directives if it has a CE marking. For computer systems to remain CE compliant, only CE-compliant parts may be used. Maintaining CE compliance also requires proper cable and cabling techniques.

RoHS Compliance



NEXCOM RoHS Environmental Policy and Status Update

NEXCOM is a global citizen for building the digital infrastructure. We are committed to providing green products and services, which are compliant with European Union RoHS (Restriction on Use of Hazardous Substance in Electronic Equipment) directive 2011/65/EU, to be your trusted green partner and to protect our environment.

RoHS restricts the use of Lead (Pb) < 0.1% or 1,000ppm, Mercury (Hg) < 0.1% or 1,000ppm, Cadmium (Cd) < 0.01% or 100ppm, Hexavalent Chromium (Cr6+) < 0.1% or 1,000ppm, Polybrominated biphenyls (PBB) < 0.1% or 1,000ppm, and Polybrominated diphenyl Ethers (PBDE) < 0.1% or 1,000ppm.

In order to meet the RoHS compliant directives, NEXCOM has established an engineering and manufacturing task force to implement the introduction of green products. The task force will ensure that we follow the standard NEXCOM development procedure and that all the new RoHS components and new manufacturing processes maintain the highest industry quality levels for which NEXCOM are renowned.

The model selection criteria will be based on market demand. Vendors and suppliers will ensure that all designed components will be RoHS compliant.

How to recognize NEXCOM RoHS Products?

For existing products where there are non-RoHS and RoHS versions, the suffix "(LF)" will be added to the compliant product name.

All new product models launched after January 2013 will be RoHS compliant. They will use the usual NEXCOM naming convention.

Warranty and RMA

NEXCOM Warranty Period

NEXCOM manufactures products that are new or equivalent to new in accordance with industry standard. NEXCOM warrants that products will be free from defect in material and workmanship for 2 years, beginning on the date of invoice by NEXCOM.

NEXCOM Return Merchandise Authorization (RMA)

- Customers shall enclose the “NEXCOM RMA Service Form” with the returned packages.
- Customers must collect all the information about the problems encountered and note anything abnormal or, print out any on-screen messages, and describe the problems on the “NEXCOM RMA Service Form” for the RMA number apply process.
- Customers can send back the faulty products with or without accessories (manuals, cable, etc.) and any components from the card, such as CPU and RAM. If the components were suspected as part of the problems, please note clearly which components are included. Otherwise, NEXCOM is not responsible for the devices/parts.
- Customers are responsible for the safe packaging of defective products, making sure it is durable enough to be resistant against further damage and deterioration during transportation. In case of damages occurred during transportation, the repair is treated as “Out of Warranty.”
- Any products returned by NEXCOM to other locations besides the customers’ site will bear an extra charge and will be billed to the customer.

Repair Service Charges for Out-of-Warranty Products

NEXCOM will charge for out-of-warranty products in two categories, one is basic diagnostic fee and another is component (product) fee.

System Level

- Component fee: NEXCOM will only charge for main components such as SMD chip, BGA chip, etc. Passive components will be repaired for free, ex: resistor, capacitor.
- Items will be replaced with NEXCOM products if the original one cannot be repaired. Ex: motherboard, power supply, etc.
- Replace with 3rd party products if needed.
- If RMA goods can not be repaired, NEXCOM will return it to the customer without any charge.

Board Level

- Component fee: NEXCOM will only charge for main components, such as SMD chip, BGA chip, etc. Passive components will be repaired for free, ex: resistors, capacitors.
- If RMA goods can not be repaired, NEXCOM will return it to the customer without any charge.

Warnings

Read and adhere to all warnings, cautions, and notices in this guide and the documentation supplied with the chassis, power supply, and accessory modules. If the instructions for the chassis and power supply are inconsistent with these instructions or the instructions for accessory modules, contact the supplier to find out how you can ensure that your computer meets safety and regulatory requirements.

Cautions

Electrostatic discharge (ESD) can damage system components. Do the described procedures only at an ESD workstation. If no such station is available, you can provide some ESD protection by wearing an antistatic wrist strap and attaching it to a metal part of the computer chassis.

Safety Information

Before installing and using the device, note the following precautions:

- Read all instructions carefully.
- Do not place the unit on an unstable surface, cart, or stand.
- Follow all warnings and cautions in this manual.
- When replacing parts, ensure that your service technician uses parts specified by the manufacturer.
- Avoid using the system near water, in direct sunlight, or near a heating device.
- The load of the system unit does not solely rely for support from the rackmounts located on the sides. Firm support from the bottom is highly necessary in order to provide balance stability.
- The computer is provided with a battery-powered real-time clock circuit. There is a danger of explosion if battery is incorrectly replaced. Replace only with the same or equivalent type recommended by the manufacturer. Discard used batteries according to the manufacturer's instructions.



Danger of explosion if battery is incorrectly replaced. Replace with the same or equivalent type recommended by the manufacturer. Discard used batteries according to the manufacturer's instructions.

Installation Recommendations

Ensure you have a stable, clean working environment. Dust and dirt can get into components and cause a malfunction. Use containers to keep small components separated.

Adequate lighting and proper tools can prevent you from accidentally damaging the internal components. Most of the procedures that follow require only a few simple tools, including the following:

- A Philips screwdriver
- A flat-tipped screwdriver
- A grounding strap
- An anti-static pad

Using your fingers can disconnect most of the connections. It is recommended that you do not use needle-nose pliers to disconnect connections as these can damage the soft metal or plastic parts of the connectors.

Safety Precautions

1. Read these safety instructions carefully.
2. Keep this User Manual for later reference.
3. Disconnect this equipment from any AC outlet before cleaning. Use a damp cloth. Do not use liquid or spray detergents for cleaning.
4. For plug-in equipment, the power outlet socket must be located near the equipment and must be easily accessible.
5. Keep this equipment away from humidity.
6. Put this equipment on a stable surface during installation. Dropping it or letting it fall may cause damage.
7. The openings on the enclosure are for air convection to protect the equipment from overheating. **DO NOT COVER THE OPENINGS.**
8. Make sure the voltage of the power source is correct before connecting the equipment to the power outlet.
9. Place the power cord in a way so that people will not step on it. Do not place anything on top of the power cord. Use a power cord that has been approved for use with the product and that it matches the voltage and current marked on the product's electrical range label. The voltage and current rating of the cord must be greater than the voltage and current rating marked on the product.
10. All cautions and warnings on the equipment should be noted.
11. If the equipment is not used for a long time, disconnect it from the power source to avoid damage by transient overvoltage.
12. Never pour any liquid into an opening. This may cause fire or electrical shock.
13. Never open the equipment. For safety reasons, the equipment should be opened only by qualified skilled person.
14. If one of the following situations arises, get the equipment checked by service personnel:
 - a. The power cord or plug is damaged.
 - b. Liquid has penetrated into the equipment.
 - c. The equipment has been exposed to moisture.
 - d. The equipment does not work well, or you cannot get it to work according to the user's manual.
 - e. The equipment has been dropped and damaged.
 - f. The equipment has obvious signs of breakage.
15. Do not place heavy objects on the equipment.
16. The equipment is intended to be supplied by DC mains, it will not tolerate voltage supplied below 24Vdc, and without PE connection.
17. This equipment is not suitable for use in locations where children are likely to be present.
18. **CAUTION: DANGER OF EXPLOSION IF BATTERY IS INCORRECTLY REPLACED. REPLACE ONLY WITH THE SAME OR EQUIVALENT TYPE RECOMMENDED BY THE MANUFACTURER. DISCARD USED BATTERIES ACCORDING TO THE MANUFACTURER'S INSTRUCTIONS.**

Technical Support and Assistance

1. For the most updated information of NEXCOM products, visit NEXCOM's website at www.nexcom.com.
2. For technical issues that require contacting our technical support team or sales representative, please have the following information ready before calling:
 - Product name and serial number
 - Detailed information of the peripheral devices
 - Detailed information of the installed software (operating system, version, application software, etc.)
 - A complete description of the problem
 - The exact wordings of the error messages

Warning!

1. Handling the unit: carry the unit with both hands and handle it with care.
2. Maintenance: to keep the unit clean, use only approved cleaning products or clean with a dry cloth.

Conventions Used in this Manual



Warning:

Information about certain situations, which if not observed, can cause personal injury. This will prevent injury to yourself when performing a task.



Caution:

Information to avoid damaging components or losing data.



Note:

Provides additional information to complete a task easily.

Global Service Contact Information

Headquarters

NEXCOM International Co., Ltd.

9F, No. 920, Chung-Cheng Rd.,
Zhonghe District, New Taipei City, 23586,
Taiwan, R.O.C.

Tel: +886-2-8226-7786

Fax: +886-2-8226-7782

www.nexcom.com

Asia

Taiwan

NexAIoT Headquarters

Industry 4.0 and Cloud Services

13F, No.916, Zhongzheng Rd.,
Zhonghe District, New Taipei City,
23586, Taiwan, R.O.C.

Tel: +886-2-8226-7796

Fax: +886-2-8226-7926

Email: sales@nexaiot.com

www.nexaiot.com

NexAIoT Co., Ltd.

Taichung Office

16F, No.250, Sec. 2, Chongde Rd.,
Beitun District,

Taichung City, 406, Taiwan, R.O.C.

Tel: +886-4-2249-1179

Fax: +886-4-2249-1172

Email: sales@nexaiot.com

www.nexaiot.com

NexCOBOT Taiwan Co., Ltd.

13F, No.916, Chung-Cheng Rd.,
Zhonghe District,
New Taipei City, 23586, Taiwan, R.O.C.

Tel: +886-2-8226-7786

Fax: +886-2-8226-7926

Email: sales@nexcobot.com

www.nexcobot.com

GreenBase Technology Corp.

13F, No.922, Chung-Cheng Rd.,
Zhonghe District,
New Taipei City, 23586, Taiwan, R.O.C.

Tel: +886-2-8226-7786

Fax: +886-2-8226-7900

Email: sales@nexcom.com.tw

www.nexcom.com.tw

EMBUX Technology Co., Ltd.

13F, No.916, Chung-Cheng Rd.,
Zhonghe District,
New Taipei City, 23586, Taiwan, R.O.C.

Tel: +886-2-8226-7786

Fax: +886-2-8226-7782

Email: sales@nexcom.com.tw

www.nexcom.com.tw

TMR Technology Corp.

13F, No.916, Chung-Cheng Rd.,
Zhonghe District,
New Taipei City, 23586, Taiwan, R.O.C.

Tel: +886-2-8226-7786

Fax: +886-2-8226-7782

Email: sales@nexcom.com.tw

www.nexcom.com.tw

China

NEXSEC Incorporated

5F, No.4, No.7 Fengxian Middle Rd.,
(Beike Industrial Park), Haidian District,
Beijing, 100094, China

Tel: +86-10-5704-2680

Fax: +86-10-5704-2681

Email: marketing@nexsec.cn

www.nexsec.cn

NEXCOM Shanghai

No.4, 16 Building,
Shanghai OMNI Tech & Science Park
No. 1699, Douhui Rd.,
Shanghai, 201108, China

Tel: +86-21-5278-5868

Fax: +86-21-3251-6358

Email: sales@nexcom.cn

www.nexcom.cn

NEXCOM Surveillance Technology Corp.

5F, Building C, ZhenHan Industrial Zone,
GanKeng Community, Buji Street,
LongGang District,
ShenZhen, 518112, China
Tel: +86-755-8364-7768
Fax: +86-755-8364-7738
Email: steveyang@nexcom.com.tw
www.nexcom.cn

NEXCOM United System Service

Room 603/604, Huiyinmingzun Plaza Bldg. 1,
No. 609, Yunlin East Rd.,
Shanghai, 200062, China
Tel: +86-21-5278-5868
Fax: +86-21-3251-6358
Email: renwang@nexcom.com.tw
www.nexcom.cn

NEXGOL Chongqing

1F, Building B4, Electronic 2nd Area,
(Phoenix Lake Industrial Park), Yongchuan Dist.,
Chongqing City, 402160, China
Tel: +86-23-4960-9080
Fax: +86-23-4966-5855
Email: sales@nexgol.com.cn
www.nexcobot.com/NexGOL

NexCOBOT China

Room 501, Building 1, Haichuang Building,
No.7 Qingyi Road, Guicheng Street,
Nanhai District, Foshan City,
Guangdong Province, 528314, China
Tel: +86-757-8625-7118
Email: sales@nexcobot.com
www.nexcobot.com.cn

Beijing NexGemo Technology Co.,Ltd.

5F, Gemotech Building, No.1, Development Rd.,
Changping International Information Industry Base,
Changping District,
Beijing, 102206, China
Tel: +86-10-8190-9328
Fax: +86-10-8190-9456
Email: sales@gemotech.cn
www.nexgemo.cn

Japan

NEXCOM Japan

9F, Tamachi Hara Bldg.,
4-11-5, Shiba Minato-ku,
Tokyo, 108-0014, Japan
Tel: +81-3-5419-7830
Fax: +81-3-5419-7832
Email: sales@nexcom-jp.com
www.nexcom-jp.com

America

USA NEXCOM USA

46665 Fremont Blvd.,
Fremont CA 94538, USA
Tel: +1-510-656-2248
Fax: +1-510-656-2158
Email: sales@nexcom.com
www.nexcomusa.com

NexCOBOT USA

2883 Bayview Drive,
Fremont CA 94538, USA
Tel: +1-510-362-0800
Fax: +1-510-656-2158
Email: sales@nexcobot.com
www.nexcobot.com

Europe

United Kingdom NEXCOM EUROPE

10 Vincent Avenue,
Crownhill Business Centre,
Milton Keynes, Buckinghamshire
MK8 0AB, United Kingdom
Tel: +44-1908-267121
Fax: +44-1908-262042
Email: sales.uk@nexcom.eu
www.nexcom.co.uk

Package Contents

Before continuing, verify that the NISE 4300 package that you received is complete. Your package should have all the items listed in the following table.

Item	Part Number	Description	Qty
1	60177A0725X00	NISE 4300 Series Quick Reference Guide VER:A	1
2	50311F0326X00	Screw for HDD/SSD (Flat Head Screw Long Fei:F3x5 Nylok Ni+Heat Treatment)	4
3	50311F0294X00	Screw for Mini-PCIe Card (I Head Screw Long Fei:I2x4 Nylok NIGP)	1
4	50311F0530X00	Screw for M.2 Module (I Head Screw Long Fei:I3x6 ISO ISO w/ Spring+Washer NI)	1
5	4NCPM00302X00	Terminal Blocks 3P Phoenix Contact:1777992 5.08mm Male DIP Green	1

Ordering Information

The following information below provides ordering information for NISE 4300.

NISE 4300-6300U System (P/N: 10J00430001X0)

6th generation Intel® Core™ i5-6300U fanless system

NISE 4300-6100U System (P/N: 10J00430000X0)

6th generation Intel® Core™ i3-6100U fanless system

24V, 120W AC to DC power adapter w/o power cord (P/N: 7400120026X00)

CHAPTER 1: PRODUCT INTRODUCTION

Overview



Front View



Rear View

Key Features

- Support 6th generation Intel® Core™ i5/i3 BGA type processor
- Support 1 x 2.5" SATA HDD
- 2 x DP, and 1 x LVDS (internal) with independent display support
- 2 x Intel® GbE LAN ports
- 1 x M.2 B Key socket and 1 x mini-PCIe socket
- 2 x USB 3.0, 2 x USB 2.0, 2 x RS232, 1 x RS232/422/485 with auto flow control
- Support +24VDC input; ATX power mode
- Panel PC adaptable (by request)

Hardware Specifications

CPU Support

- Support 6th generation Intel® Core™ i5/i3 BGA type processor
 - Intel® Core™ i5-6300U, 3M Cache, up to 3.00 GHz
 - Intel® Core™ i3-6100U, 3M Cache, up to 2.3 GHz
- Turbo-boost disabled by default (Intel® Core™ i3-6100U does not support turbo boost function)

Main Memory

- 2 x DDR3L 1866 SO-DIMM sockets, support up to 16GB with un-buffered and non-ECC (pre-installation is necessary for users who require more than 8GB memory)

Display Option

- Box PC only, DP1 + DP2, two independent displays
- With panel PC, LVDS + DP1 + DP2, three independent displays (by request)

Front I/O Interface Status LEDs

- 1 x Power LED
- 1 x GPIO programmable LED
- 1 x SATA LED

Front I/O Interface

- 1 x ATX power on/off switch
- 1 x 3-pin 24V DC input
- 2 x Intel® I210-IT GbE LAN
- 1 x Dual USB 2.0 ports (500mA/per port)
- 1 x Dual USB 3.0 ports (900mA/per port)
- 2 x DP1.2
- 2 x RS232 COM port

- 1 x RS232/422/485 COM port
- GPIO

Rear I/O Interface

- 2 x Antenna holes

Storage Device

- 1 x M.2 slot, supports optional 2242 B or B+M key
- 1 x 2.5" HDD or SSD

Expansion Slot

- 1 x Internal mini-PCIe socket, supports optional Wi-Fi and LTE modules

Power Requirements

- AT/ATX power mode (default: ATX power mode)
- Power input: +24V DC
- Power adapter: optional 24V 120W

Dimensions

- With wall mount bracket: 259 mm (W) x 145 mm (D) x 60 mm (H)
- Without wall mount bracket: 238 mm (W) x 145 mm (D) x 54 mm (H)

Construction

- Aluminum and metal chassis with fanless design

Environment

- Operating temperature:
Ambient with air flow: 0°C to 50°C
(according to IEC60068-2-1, IEC60068-2-2, IEC60068-2-14)
- Storage temperature: -20°C to 80°C
- Relative humidity: 10% to 90% (non-condensing)
- Shock protection:
 - HDD: 20G, half sine, 11ms, IEC60068-2-27
 - M.2: 50G, half sine, 11ms, IEC60068-2-27
- Vibration protection with HDD condition:
 - Random: 0.5Grms @ 5~500 Hz, IEC60068-2-64
 - Sinusoidal: 0.5Grms @ 5~500 Hz, IEC60068-2-6

Certifications

- CE approval - EN61000-6-2, EN61000-6-4
- FCC Class A

OS Support List

- Windows 10 IoT 64-bit
- Windows 7 Pro 64-bit
- WES7P 64-bit

Weight Information

- Gross weight: 2.3kg
- Net weight: 1.8kg

Knowing Your NISE 4300

Front Panel

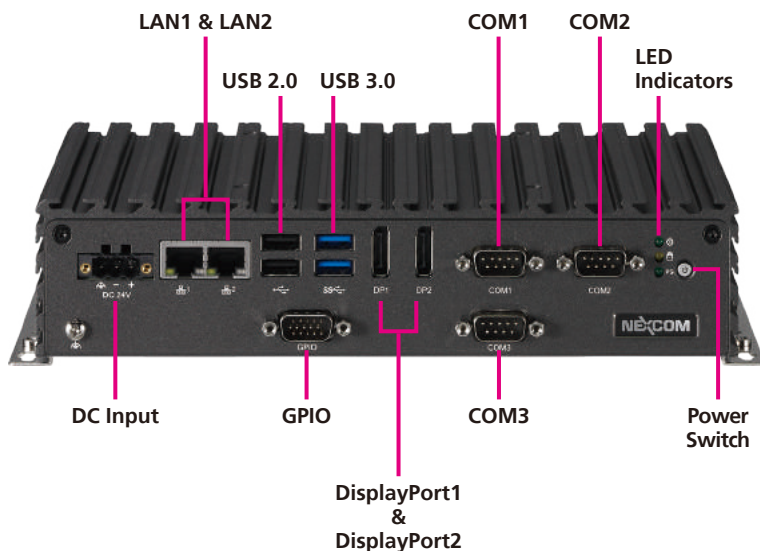

DC Input

Used to plug a DC power cord.

LAN1 and LAN2

Used to connect the system to a local area network.

USB 2.0

USB 2.0 ports to connect the system with USB 2.0/1.1 devices.

USB 3.0

USB 3.0 ports to connect the system with USB 3.0/2.0 devices.

COM1 and COM2

DB9 port used to connect RS232 compatible devices.

COM3

DB9 port used to connect RS232/422/485 compatible devices.

LED Indicators

Two LED indicators for displaying the power status and storage activity of the system, and one LED for programming GPIO.

Power Switch

Press to power-on or power-off the system.

GPIO

The GPIO connector supports 4-channel GPO and 4-channel GPI.

DisplayPort1 and DisplayPort2

Used to connect DisplayPort interface displays.

Rear Panel



Antenna Holes

Antenna Holes

The external antenna mounting holes are used to mount and connect optional Wi-Fi antennas.

Mechanical Dimensions

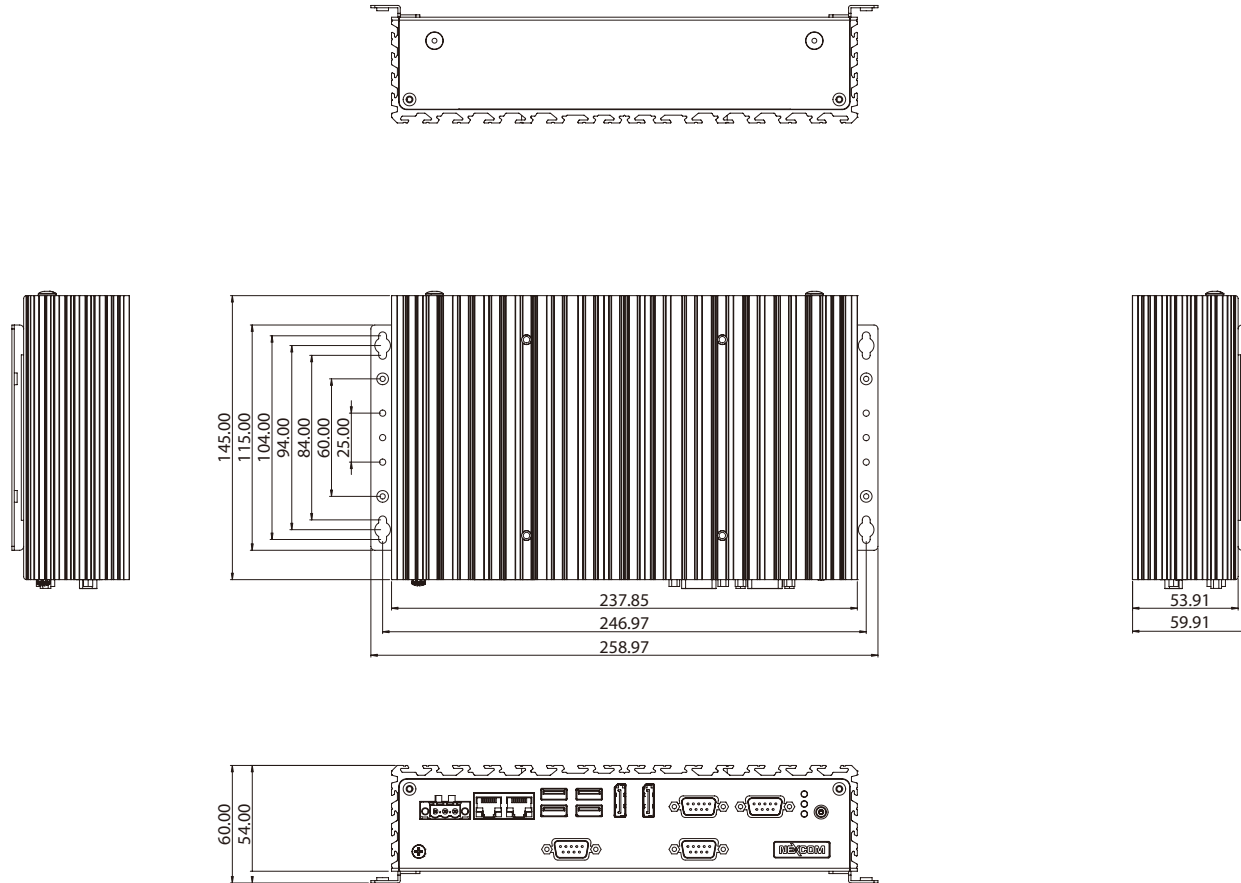

CHAPTER 2: JUMPERS AND CONNECTORS

This chapter describes how to set the jumpers and connectors on the NISE 4300 motherboard.

Before You Begin

- Ensure you have a stable, clean working environment. Dust and dirt can get into components and cause a malfunction. Use containers to keep small components separated.
- Adequate lighting and proper tools can prevent you from accidentally damaging the internal components. Most of the procedures that follow require only a few simple tools, including the following:
 - A Philips screwdriver
 - A flat-tipped screwdriver
 - A set of jewelers screwdrivers
 - A grounding strap
 - An anti-static pad
- Using your fingers can disconnect most of the connections. It is recommended that you do not use needle-nosed pliers to disconnect connections as these can damage the soft metal or plastic parts of the connectors.
- Before working on internal components, make sure that the power is off. Ground yourself before touching any internal components, by touching a metal object. Static electricity can damage many of the electronic components. Humid environments tend to have less static electricity than

dry environments. A grounding strap is warranted whenever danger of static electricity exists.

Precautions

Computer components and electronic circuit boards can be damaged by discharges of static electricity. Working on computers that are still connected to a power supply can be extremely dangerous.

Follow the guidelines below to avoid damage to your computer or yourself:

- Always disconnect the unit from the power outlet whenever you are working inside the case.
- If possible, wear a grounded wrist strap when you are working inside the computer case. Alternatively, discharge any static electricity by touching the bare metal chassis of the unit case, or the bare metal body of any other grounded appliance.
- Hold electronic circuit boards by the edges only. Do not touch the components on the board unless it is necessary to do so. Don't flex or stress the circuit board.
- Leave all components inside the static-proof packaging that they shipped with until they are ready for installation.
- Use correct screws and do not over tighten screws.

Jumper Settings

A jumper is the simplest kind of electric switch. It consists of two metal pins and a cap. When setting the jumpers, ensure that the jumper caps are placed on the correct pins. When the jumper cap is placed on both pins, the jumper is short. If you remove the jumper cap, or place the jumper cap on just one pin, the jumper is open.

Refer to the illustrations below for examples of what the 2-pin and 3-pin jumpers look like when they are short (on) and open (off).

Two-Pin Jumpers: Open (Left) and Short (Right)

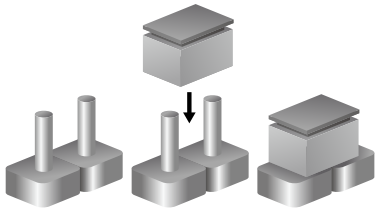

Three-Pin Jumpers: Pins 1 and 2 are Short

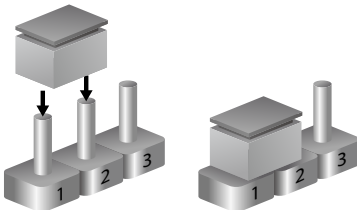

Locations of the Jumpers and Connectors for NISB 4300

NISB 4300

The following figures are the top and bottom view of the NISB 4300 main board which is the main board used in NISE 4300. It shows the locations of the jumpers and connectors.

Top View

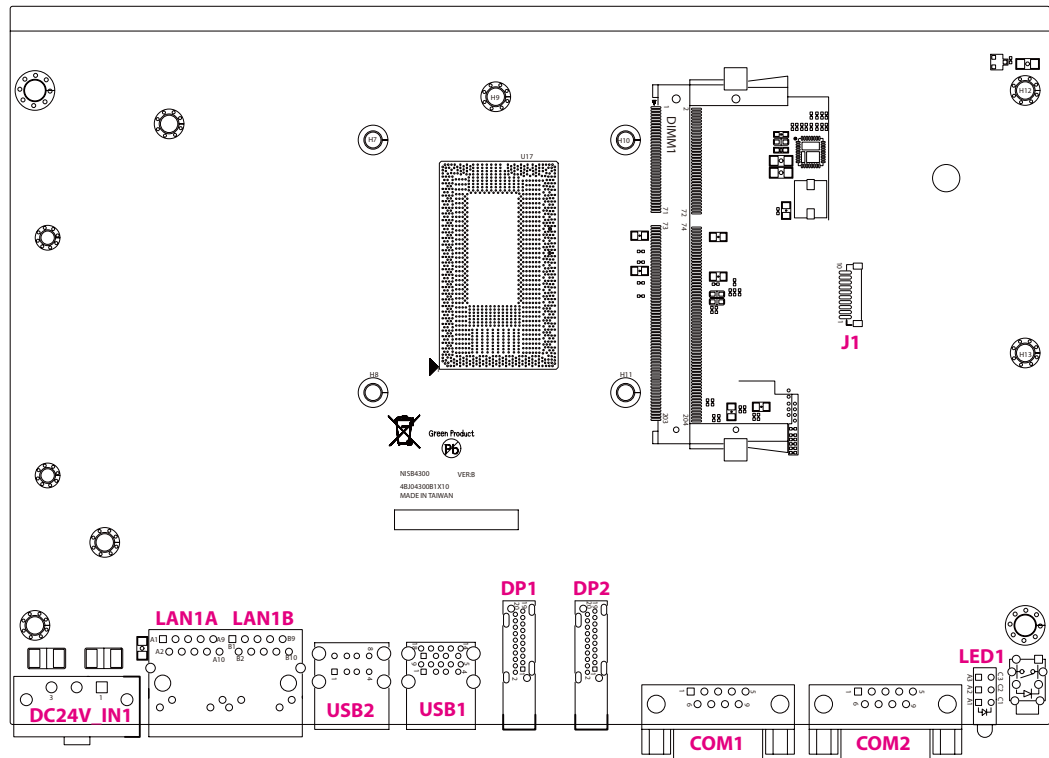

Bottom View

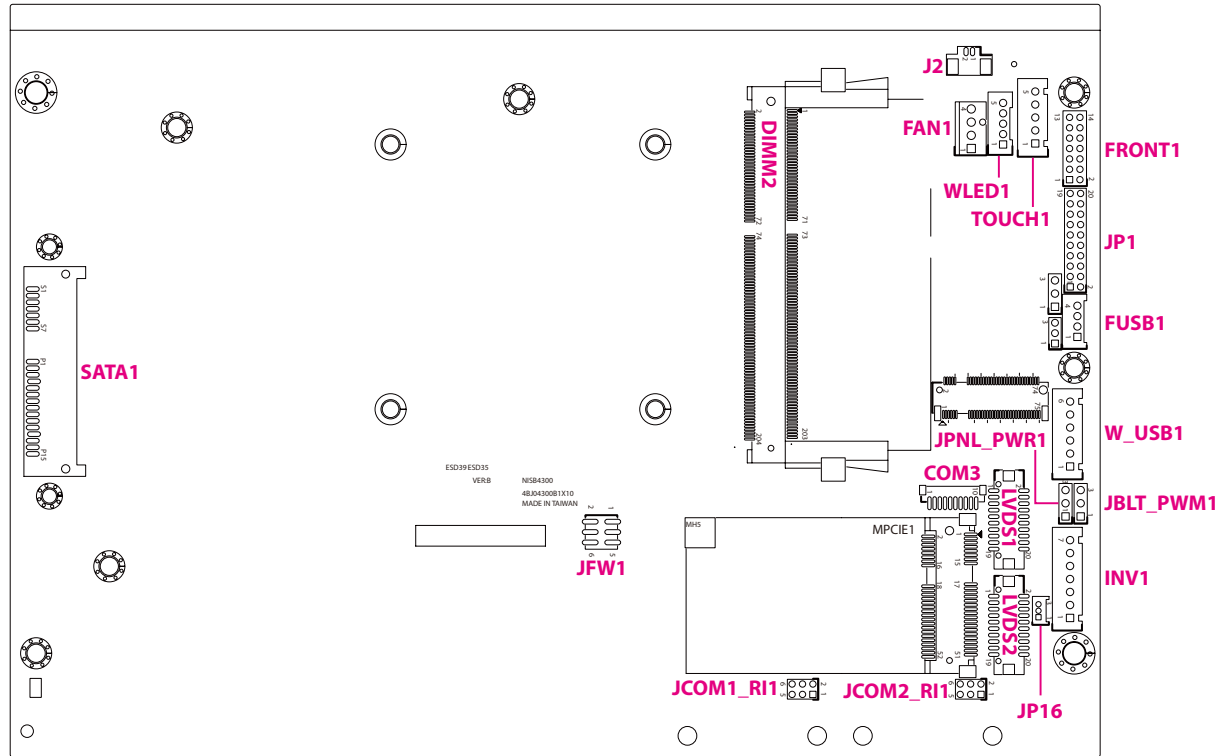

Jumpers

LVDS Panel Power Selection

Connector type: 1x3 3-pin header

Connector location: JPNL_PWR1



Pin	Settings
1-2 On	+3V3
2-3 On	+5V

Backlight Volume Selection

Connector type: 1x3 3-pin header

Connector location: JBLT_PWM1



Pin	Settings
1-2 On	+3V3
2-3 On	+5V

COM1 Port Power Setting

Connector type: 2x3 6-pin header
Connector location: JCOM1_R11

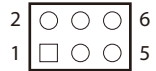

Pin	Settings
1-2 On	+12V
3-4 On	RING
5-6 On	+5V

COM2 Port Power Setting

Connector type: 2x3 6-pin header
Connector location: JCOM2_R11

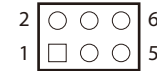

Pin	Settings
1-2 On	+12V
3-4 On	RING
5-6 On	+5V

Connector Pin Definitions

External I/O Interfaces - Front Panel

DC Power Input

Connector type: 3-pin terminal block

Connector location: DC24V_IN1

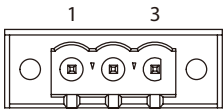

Pin	Definition
1	+24V
2	GND
3	CHASSIS GND

LAN1 and LAN2 Ports

Connector type: RJ45 port

Connector location: LAN1A and LAN1B

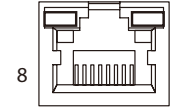

Pin	Definition	Pin	Definition
1	LAN_MDI0P	2	LAN_MDI0N
3	LAN_MDI1P	4	LAN_MDI1N
5	LAN_MDI2P	6	LAN_MDI2N
7	LAN_MDI3P	8	LAN_MDI3N
9	LAN_VCC	10	GND
11	LAN_LINK1G#	12	LAN_LINK100#
13	LAN_ACT#_	14	LAN_ACTPW

USB 2.0 Ports

Connector type: Dual USB 2.0 ports

Connector location: USB2

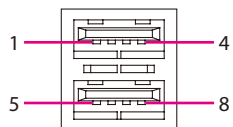

Pin	Definition	Pin	Definition
1	+5V	2	USB2_3N
3	USB2_3P	4	GND
5	+5V	6	USB2_4N
7	USB2_4P	8	GND

USB 3.0 Ports

Connector type: Dual USB 3.0 ports

Connector location: USB1

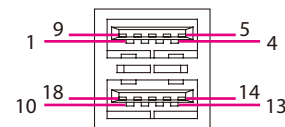

Pin	Definition	Pin	Definition
1	+5V	2	USB2_1N
3	USB2_1P	4	GND
5	USB3_RX1_N	6	USB3_RX1_P
7	GND	8	USB3_TX1_N
9	USB3_TX1_P	10	+5V
11	USB2_2N	12	USB2_2P
13	GND	14	USB3_RX2_N
15	USB3_RX2_P	16	GND
17	USB3_TX2_N	18	USB3_TX2_P

DisplayPort

Connector type: DisplayPort

Connector location: DP1 and DP2

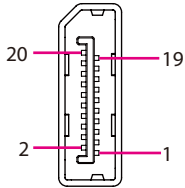

Pin	Definition	Pin	Definition
1	LANE0_P	2	GND
3	LANE0_N	4	LANE1_P
5	GND	6	LANE1_N
7	LANE2_P	8	GND
9	LANE2_N	10	LANE3_P
11	GND	12	LANE3_N
13	CONFIG1	14	CONFIG2
15	AUX_P	16	GND
17	AUX_N	18	HPD
19	DP_RETURN	20	DP_PWR

COM1 and COM2 Ports

Connector type: DB-9 port, 9-pin D-Sub

Connector location: COM1 and COM2

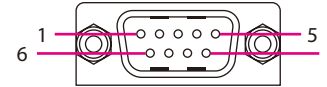

Pin	Definition	Pin	Definition
1	COM_DCD#	2	COM_RXD
3	COM_TXD	4	COM_DTR#
5	GND	6	COM_DSR#
7	COM_RTS#	8	COM_CTS#
9	RI#		

LED Indicators

Connector location: LED1

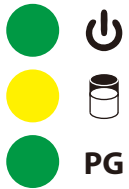

Pin	Definition
C1	GPIO LED (Green) (Customer Defined)
C2	SATA LED (Yellow)
C3	POWER LED (Green)

Internal Connectors

Debug Connector

Connector type: 1x10 10-pin header

Connector location: J1



Pin	Definition	Pin	Definition
1	GND	2	LPC_PLTRST#
3	LPC_CLK	4	LPC_LFRAME#
5	LPC_LAD3	6	LPC_LAD2
7	LPC_LAD1	8	LPC_LAD0
9	LPC_SERIRQ	10	VCC3

LED Connector

Connector type: 1x5 5-pin header

Connector location: WLED1

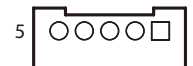

Pin	Definition	Pin	Definition
1	HDD_LED-	2	HDD_LED+
3	GND	4	STBY_LED+
5	POWER_LED+		

LVDS Connector

Connector type: 2x10 20-pin header

Connector location: LVDS1

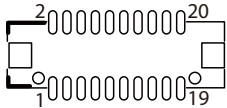

Pin	Definition	Pin	Definition
1	CH7511_GPIO0	2	CH7511_GPIO1
3	+VCC_LCD	4	LVDSA_LDC0P
5	LVDSA_LDC3P	6	LVDSA_LDC0N
7	LVDSA_LDC3N	8	+VCC_LCD
9	GND	10	LVDSA_LDC1P
11	LVDSA_LL1CP	12	LVDSA_LDC1N
13	LVDSA_LL1CN	14	GND
15	GND	16	+V_INV
17	LVDSA_LDC2P	18	+V_INV
19	LVDSA_LDC2N	20	LVDS_DISABLE#

LVDS Connector

Connector type: 2x10 20-pin header

Connector location: LVDS2

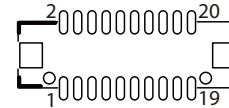

Pin	Definition	Pin	Definition
1	CH7511_GPIO2	2	CH7511_GPIO3
3	+VCC_LCD	4	LVDSB_LDC4P
5	LVDSB_LDC7P	6	LVDSB_LDC4N
7	LVDSB_LDC7N	8	+VCC_LCD
9	GND	10	LVDSB_LDC5P
11	LVDSB_LL2CP	12	LVDSB_LDC5N
13	LVDSB_LL2CN	14	GND
15	GND	16	+V_INV
17	LVDSB_LDC6P	18	+V_INV
19	LVDSB_LDC6P	20	GND

LVDS Inverter Connector

Connector type: 1x7 7-pin header
 Connector location: INV1

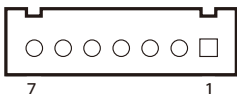

Pin	Definition	Pin	Definition
1	+5V	2	+12V
3	+12V	4	BKCTRL
5	GND	6	GND
7	BKLEN		

Front Panel Connector

Connector type: 2x7 14-pin header
 Connector location: FRONT1

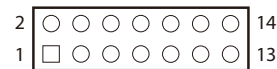

Pin	Definition	Pin	Definition
1	PWR_LED#	2	PWR_LED
3	HDD_LED#	4	HDD_LED
5	MAIN_SMBCLK	6	MAIN_SMBDATA
7	3VSB	8	GND
9	SLP_S3#	10	PS_ON
11	PWR_BTN#	12	GND
13	RST_BTN#	14	GND

Internal USB 2.0 Connector

Connector type: 1x6 6-pin header

Connector location: W_USB1

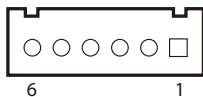

Pin	Definition	Pin	Definition
1	+5V	2	USB_8N_C
3	USB_8P_C	4	
5		6	GND

Touch Screen Connector

Connector type: 1x5 5-pin header

Connector location: TOUCH1

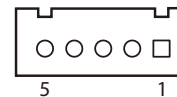

Pin	Definition	Pin	Definition
1	TOUCH_YD	2	TOUCH_XR
3	SENSE	4	TOUCH_YU
5	TOUCH_XL		

Front USB

Connector type: 1x4 4-pin header

Connector location: FUSB1

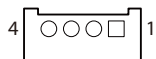

Pin	Definition	Pin	Definition
1	+5V	2	USB2N7_L
3	USB2P7_L	4	GND

GPIO Connector

Connector type: 2x10 20-pin header

Connector location: JP1

Internal Connector

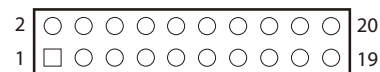

Pin	Definition	Pin	Definition
1	+5V	2	+5V
3	GPO_0	4	GPI_0
5	GPO_1	6	GPI_1
7	GPO_2	8	GPI_2
9	GPO_3	10	GPI_3
11	GPO_4	12	GPI_4
13	GPO_5	14	GPI_5
15	GPO_6	16	GPI_6
17	GPO_7	18	GPI_7
19	GND	20	GND

External Connector

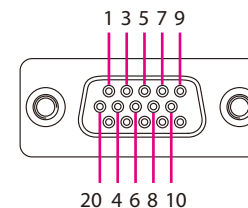

COM3 Connector (RS232/422/485)

Connector type: 1x10 10-pin header

Connector location: COM3

Internal Connector



External Connector

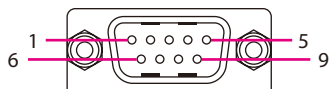

Internal Connector

RS232		RS422		RS485	
Pin	Definition	Pin	Definition	Pin	Definition
1	DCD#	1	TX-	1	RTX-
2	RXD	2	TX+	2	RTX+
3	TXD	3	RX+	3	
4	DTR#	4	RX-	4	
5	GND	5	GND	5	GND
6	DSR#	6		6	
7	RTS#	7		7	
8	CTS#	8		8	
9	RI#	9		9	

External Connector

Pin	Definition	Pin	Definition
1	DCD	2	RXD
3	TXD	4	DTR
5	GND	6	DSR
7	RTS	8	CTS
9	RI	10	GND

SATA Connector (7-pin and 15-pin)

Connector type: Standard Serial ATA 7P and 15P

Connector location: SATA1

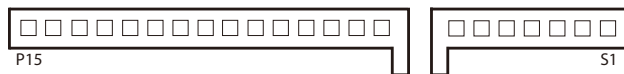

Pin	Definition	Pin	Definition
S1	GND	S2	SATA1_TXP
S3	SATA1_TXN	S4	GND
S5	SATA1_RXN	S6	SATA1_RXP
S7	GND		
P1	VCC3	P2	VCC3
P3	VCC3	P4	GND
P5	GND	P6	GND
P7	VCC5	P8	VCC5
P9	VCC5	P10	GND
P11	VCC5	P12	GND
P13	VCC12	P14	VCC12
P15	VCC12		

Battery Connector

Connector type: 1x2 2-pin header

Connector location: J2



Pin	Definition
1	GND
2	+3V

EC Debug

Connector type: 1x3 3-pin header

Connector location: JP16



Pin	Definition
1	GPIO LED (Green) (Customer Defined)
2	SATA LED (Yellow)
3	POWER LED (Green)

Fan Connector

Connector type: 1x4 4-pin header

Connector location: FAN1



Pin	Definition
1	GND
2	VCC 12
3	FAN1TACH
4	FAN1PWM

BIOS FW

Connector type: 2x3 6-pin header

Connector location: JFW1

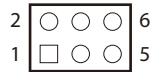

Pin	Definition	Pin	Definition
1	3VSB	2	GND
3	BIOS_CS#	4	BIOS_CLK
5	BIOS_SO	6	BIOS_SI

CHAPTER 3: SYSTEM SETUP

Removing the Chassis Bottom Cover



Prior to removing the chassis bottom cover, make sure the unit's power is off and disconnected from the power sources to prevent electric shock or system damage.

1. Remove the six mounting screws from the bottom cover.

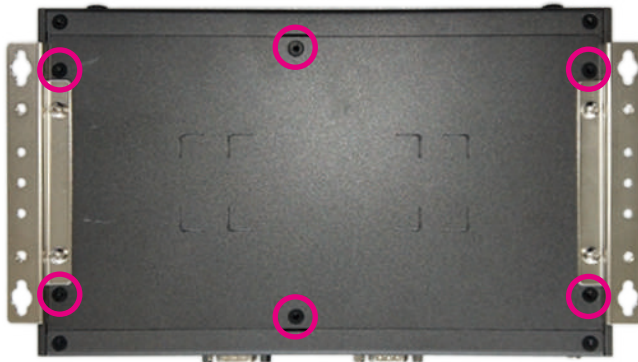

2. With the screws removed, lift up the cover and remove it from the chassis.



Installing a SO-DIMM Memory Module



Remove the bottom cover before installing a SO-DIMM.

1. Locate the SO-DIMM socket.



SO-DIMM Socket

2. Insert the module into the socket at an approximately 30-degree angle. The ejector tabs at the ends of the socket will automatically snap into the locked position to hold the module in place.



Memory Module

Installing an M.2 Storage Module

1. Locate the M.2 B key slot on the board.



M.2 B Key Slot

2. Insert the M.2 module into the M.2 slot at a 45-degree angle until the gold-plated connector on the edge of the module completely disappears into the slot.

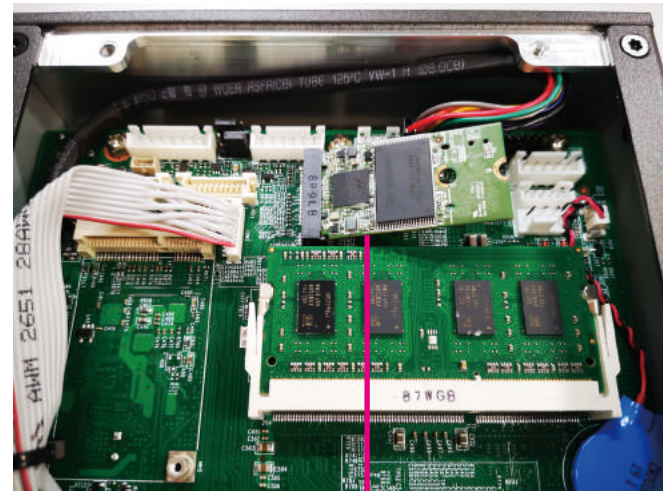

M.2 Module

3. Push the module down and secure it with a screw.



Installing a Mini-PCle Storage/Wi-Fi/LTE Module

1. Locate the mini-PCle slot on the board.



Mini-PCle Slot

2. Insert the mini-PCle module into the mini-PCle slot at a 45-degree angle until the gold-plated connector on the edge of the module completely disappears inside the slot.

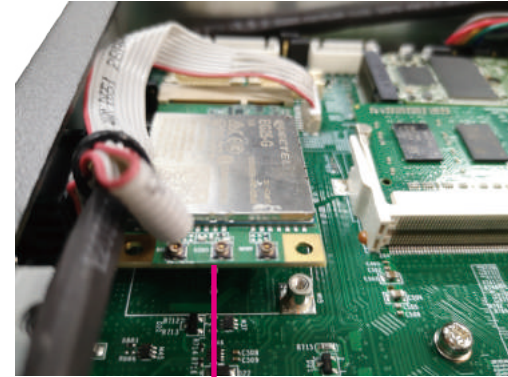

Mini-PCle Module

3. Push the module down and then secure it with a mounting screw.



Installing a Storage Drive

1. With the bottom side of the chassis facing up, unscrew the six mounting screws from the bottom cover.

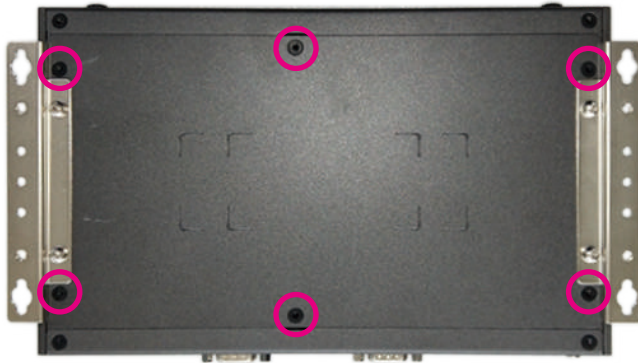

2. With the screws removed, lift up the cover and remove it from the chassis.



3. Unscrew the three screws securing the storage bracket, then remove the bracket.



4. Before installing the storage drive and storage bracket, please take note of the orientation of the SATA connector.

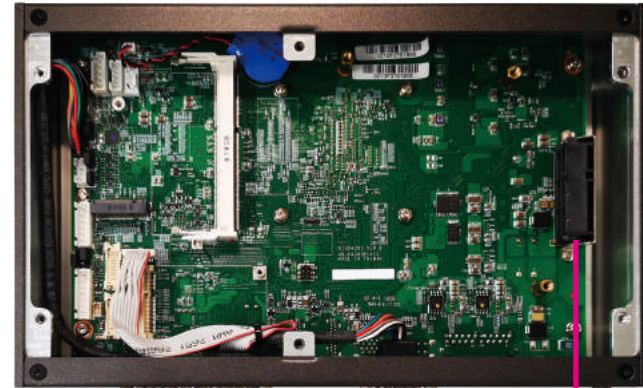

SATA Connector



SSD Gold-Plated Connector

5. Place the storage drive onto the bracket, and align the mounting holes on the storage drive with the mounting holes on the storage bracket.

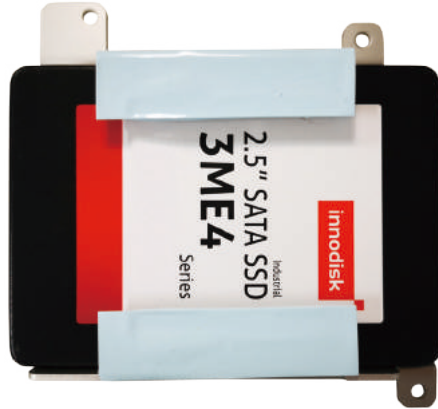

6. While supporting the storage drive, turn the bracket to the other side. From the outside of the storage bracket, secure the drive in place with screws.

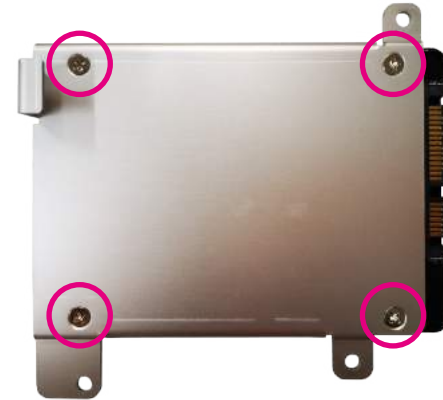

7. Plug the SSD gold-plated connector to the SATA connector, and secure the bracket with the three screws removed earlier.

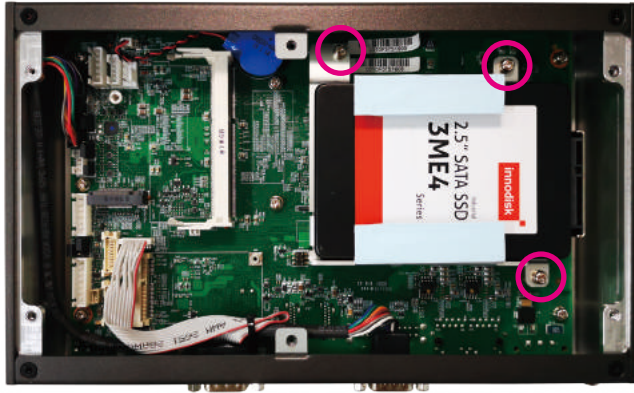

8. Secure the bottom cover to the chassis with the six screws.

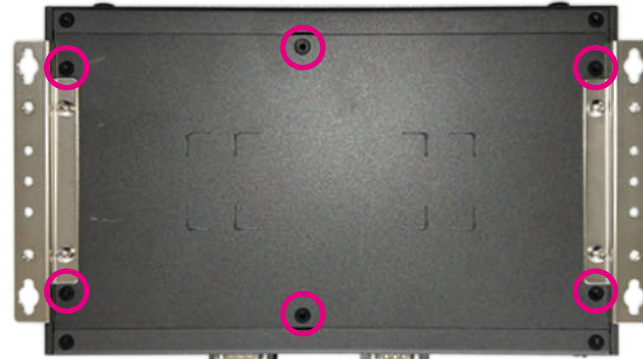

Note: If the system memory requirements are greater than 8GB, the memory will need to be pre-installed during factory assembly.

Wall Mounting Instructions

To mount the system on to a wall or some other surface using the two mounting brackets, please follow the steps below.

1. Turn the system over. Align the two retention screw holes in each bracket with the retention screw holes on the sides of the bottom surface.
2. Secure the brackets to the system by inserting two retention screws into each bracket.



Wall Mount Bracket

3. Drill holes in the intended installation surface.
4. Align the mounting holes on the sides of the mounting brackets with the predrilled holes on the mounting surface.
5. Insert four retention screws, two in each bracket, to secure the system to the wall.



Fasten screws to mount the system to the wall



Specification of the wall mount screw:
Four Round Head Screw Long Fei:P6#32Tx 1/4/SW7*0.8
w/Spring+Flat Washer

CHAPTER 4: BIOS SETUP

This chapter describes how to use the BIOS setup program for NISE 4300. The BIOS screens provided in this chapter are for reference only and may change if the BIOS is updated in the future.

To check for the latest updates and revisions, visit the NEXCOM website at www.nexcom.com.tw.

About BIOS Setup

The BIOS (Basic Input and Output System) Setup program is a menu driven utility that enables you to make changes to the system configuration and tailor your system to suit your individual work needs. It is a ROM-based configuration utility that displays the system's configuration status and provides you with a tool to set system parameters.

These parameters are stored in non-volatile battery-backed-up CMOS RAM that saves this information even when the power is turned off. When the system is turned back on, the system is configured with the values found in CMOS.

With easy-to-use pull down menus, you can configure such items as:

- Hard drives, diskette drives, and peripherals
- Video display type and display options
- Password protection from unauthorized use
- Power management features

The settings made in the setup program affect how the computer performs. It is important, therefore, first to try to understand all the setup options, and second, to make settings appropriate for the way you use the computer.

When to Configure the BIOS

- This program should be executed under the following conditions:
 - When changing the system configuration
 - When a configuration error is detected by the system and you are prompted to make changes to the setup program
 - When resetting the system clock
 - When redefining the communication ports to prevent any conflicts
 - When making changes to the Power Management configuration
 - When changing the password or making other changes to the security setup

Normally, CMOS setup is needed when the system hardware is not consistent with the information contained in the CMOS RAM, whenever the CMOS RAM has lost power, or the system features need to be changed.

Default Configuration

Most of the configuration settings are either predefined according to the Load Optimal Defaults settings which are stored in the BIOS or are automatically detected and configured without requiring any actions. There are a few settings that you may need to change depending on your system configuration.

Entering Setup











When the system is powered on, the BIOS will enter the Power-On Self Test (POST) routines. These routines perform various diagnostic checks; if an error is encountered, the error will be reported in one of two different ways:

- If the error occurs before the display device is initialized, a series of beeps will be transmitted.
- If the error occurs after the display device is initialized, the screen will display the error message.

Powering on the computer and immediately pressing allows you to enter Setup.

Press the  key to enter Setup:

Legends

Key	Function
	Moves the highlight left or right to select a menu.
	Moves the highlight up or down between sub-menus or fields.
	Exits the BIOS Setup Utility.
	Scrolls forward through the values or options of the highlighted field.
	Scrolls backward through the values or options of the highlighted field.
	Selects a field.
	Displays General Help.
	Load previous values.
	Load optimized default values.
	Saves and exits the Setup program.
	Press <Enter> to enter the highlighted sub-menu.

Scroll Bar

When a scroll bar appears to the right of the setup screen, it indicates that there are more available fields not shown on the screen. Use the up and down arrow keys to scroll through all the available fields.

Submenu

When “▶” appears on the left of a particular field, it indicates that a submenu which contains additional options are available for that field. To display the submenu, move the highlight to that field and press  .

BIOS Setup Utility

Once you enter the AMI BIOS Setup Utility, the Main Menu will appear on the screen. The main menu allows you to select from several setup functions and one exit. Use arrow keys to select among the items and press  to accept or enter the submenu.

Main

The Main menu is the first screen that you will see when you enter the BIOS Setup Utility.

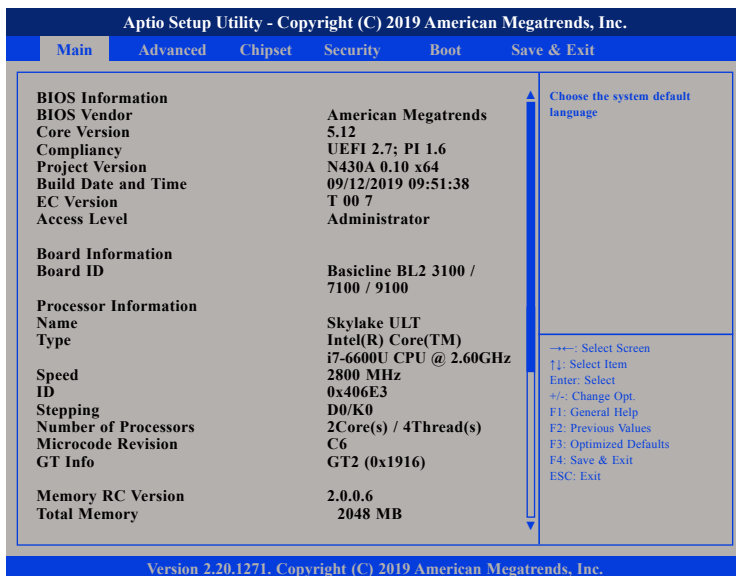

Aptio Setup Utility - Copyright (C) 2019 American Megatrends, Inc.

Main Advanced Chipset Security Boot Save & Exit

BIOS Information	American Megatrends	Choose the system default language
BIOS Vendor	5.12	
Core Version	UEFI 2.7; PI 1.6	
Compliance	N430A 0.10 x64	
Project Version	09/12/2019 09:51:38	
Build Date and Time	T 00 7	
EC Version	Administrator	
Access Level		
Board Information	Basicline BL2 3100 /	
Board ID	7100 / 9100	
Processor Information	Skylake ULT	←→: Select Screen
Name	Intel(R) Core(TM)	↑: Select Item
Type	i7-6600U CPU @ 2.60GHz	Enter: Select
Speed	2800 MHz	+/-: Change Opt.
ID	0x40E3	F1: General Help
Stepping	D0/K0	F2: Previous Values
Number of Processors	2Core(s) / 4Thread(s)	F3: Optimized Defaults
Microcode Revision	C6	F4: Save & Exit
GT Info	GT2 (0x1916)	ESC: Exit
Memory RC Version	2.0.0.6	
Total Memory	2048 MB	

Version 2.20.1271. Copyright (C) 2019 American Megatrends, Inc.

System Language

Selects the language of the system.

System Date

The date format is <day>, <month>, <date>, <year>. Day displays a day, from Monday to Sunday. Month displays the month, from January to December. Date displays the date, from 1 to 31. Year displays the year, from 1999 to 2099.

System Time

The time format is <hour>, <minute>, <second>. The time is based on the 24-hour military-time clock. For example, 1 p.m. is 13:00:00. Hour displays hours from 00 to 23. Minute displays minutes from 00 to 59. Second displays seconds from 00 to 59.

Advanced

The Advanced menu allows you to configure your system for basic operation. Some entries are defaults required by the system board, while others, if enabled, will improve the performance of your system or let you set some features according to your preference.



Setting incorrect field values may cause the system to malfunction.



CPU Configuration

This section is used to configure the CPU.

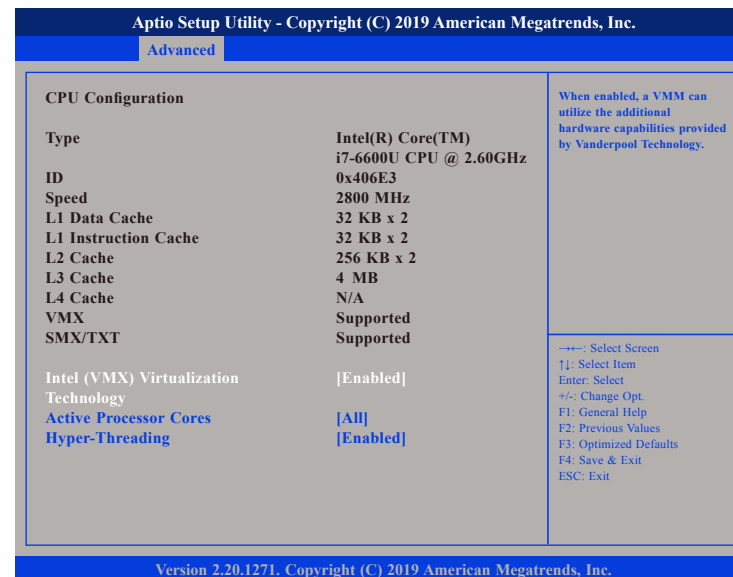

Intel® (VMX) Virtualization Technology

Enables or disables Intel Virtualization technology.

Active Processors Cores

Select the number of cores to enable in each processor package.

Hyper-Threading

Enables or disables hyper-threading technology.

Power & Performance

This section is used to configure the CPU power management features.

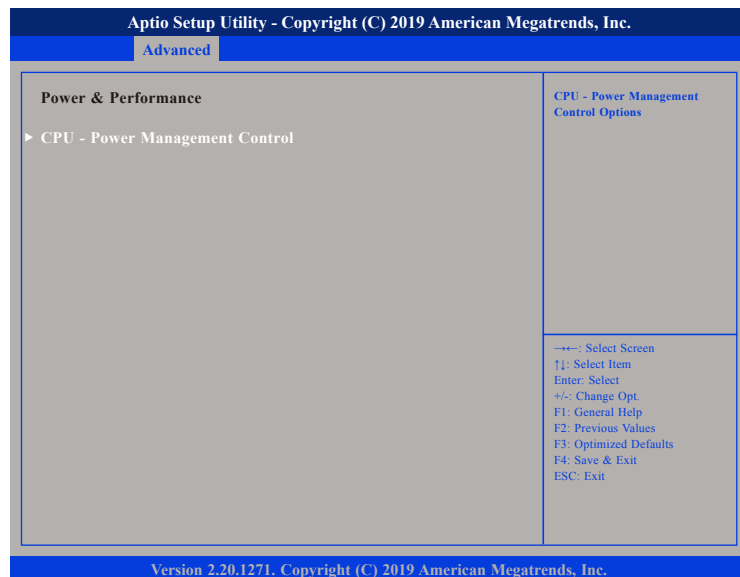

CPU - Power Management Control

Enters the CPU - Power Management Control submenu.

CPU - Power Management Control

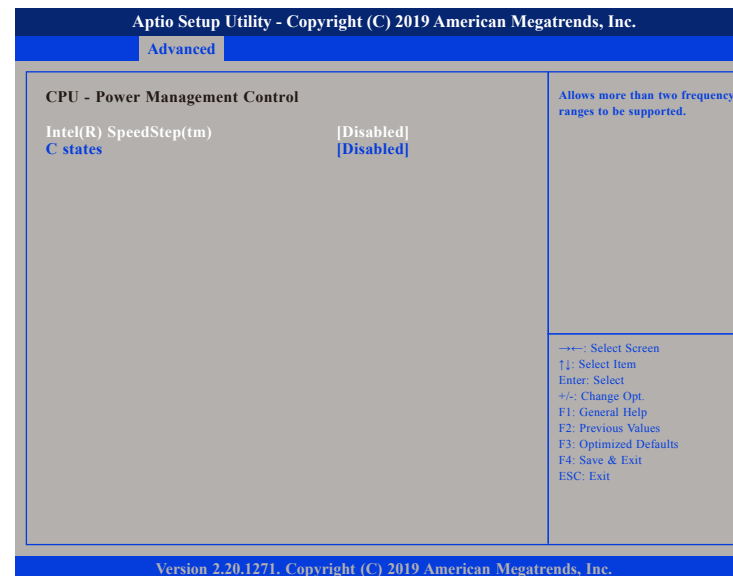

Intel® SpeedStep™

Enables or disables Intel SpeedStep technology.

C states

Enables or disables CPU C states support for power saving.

F81216SEC Super IO Configuration

This section is used to configure the serial ports.



Super IO Chip

Displays the Super I/O chip used on the board.

Serial Port 1 Configuration

This section is used to configure serial port 1.

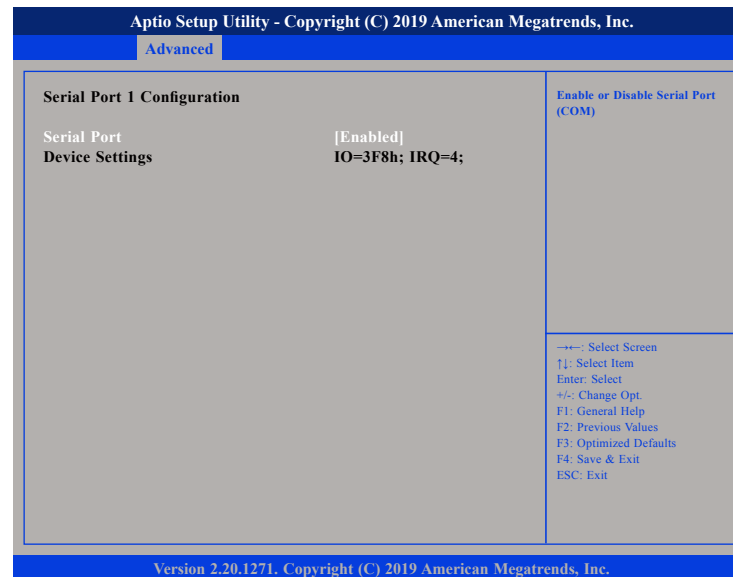

Serial Port

Enables or disables the serial port.

Serial Port 2 Configuration

This section is used to configure serial port 2.



Serial Port

Enables or disables the serial port.

Serial Port 3 Configuration

This section is used to configure serial port 3.



Serial Port

Enables or disables the serial port.

Onboard Serial Port Mode

Configures the serial port mode to RS232, RS422, RS485 or RS485 Auto.

Terminal resistor

Enables or disables the terminal resistor

IT8528 H/W Monitor

This section is used to monitor hardware status such as temperature, fan speed and voltages.

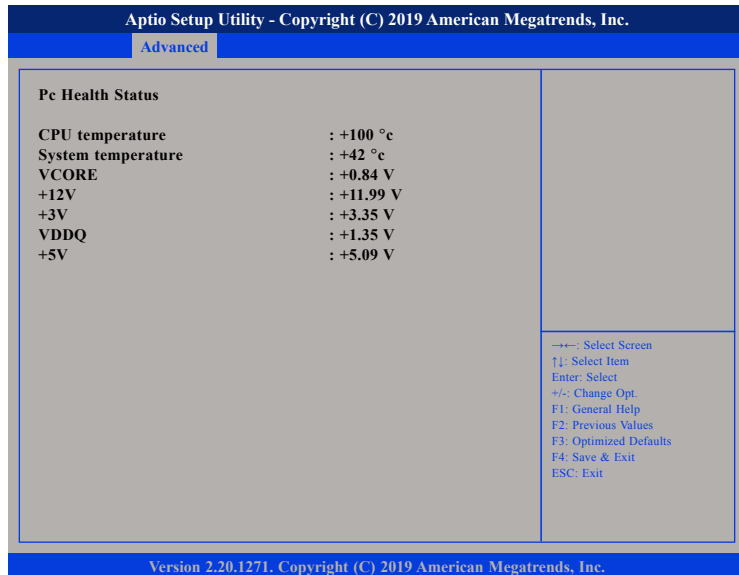

CPU temperature

Detects and displays the current CPU temperature.

System temperature

Detects and displays the current system temperature.

VCORE to +5V

Detects and displays the output voltages.

Network Stack Configuration

This section is used to configure the network stack settings.

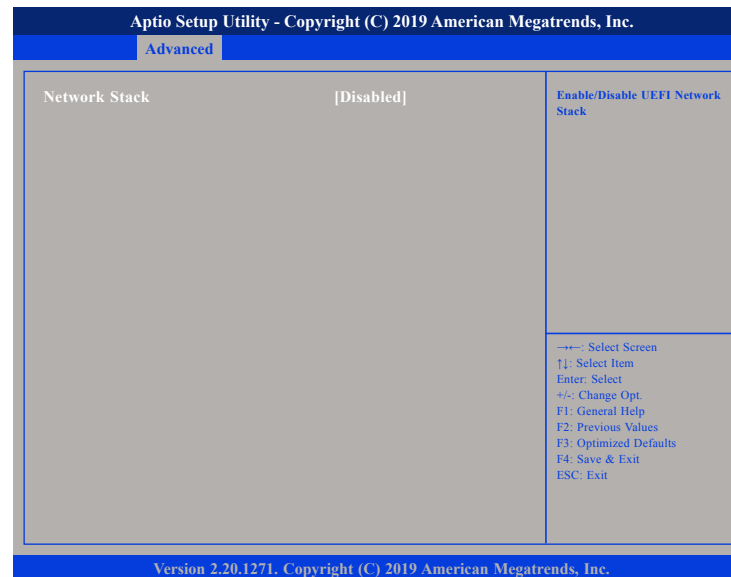

Network Stack

Enables or disables UEFI network stack.

CSM Configuration

This section is used to configure the compatibility support module features.



CSM Support

This field is used to enable or disable CSM support, if Auto option is selected, based on OS, CSM will be enabled or disabled automatically.

USB Configuration

This section is used to configure the USB.

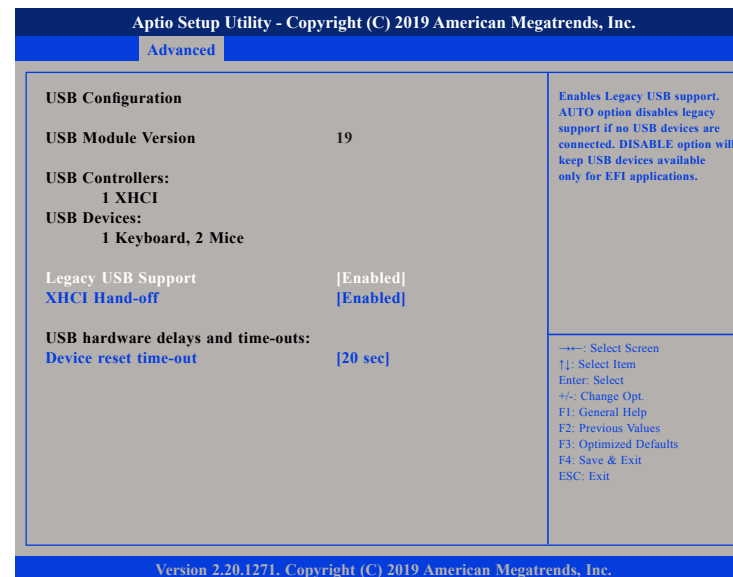

Legacy USB Support

Enabled Enables Legacy USB.

Auto Disables support for Legacy when no USB devices are connected.

Disabled Keeps USB devices available only for EFI applications.

XHCI Hand-off

This is a workaround for OSs that does not support XHCI hand-off. The XHCI ownership change should be claimed by the XHCI driver.

Device reset time-out

Selects the USB mass storage device's start unit command timeout.

Chipset

This section gives you functions to configure the system based on the specific features of the chipset. The chipset manages bus speeds and access to system memory resources.



System Agent (SA) Configuration

System Agent (SA) parameters.

PCH-IO Configuration

PCH-IO parameters.

System Agent (SA) Configuration

This section is used to configure the System Agent (SA) configuration.



VT-d

Enables or disables VT-d function on MCH.

Graphics Configuration

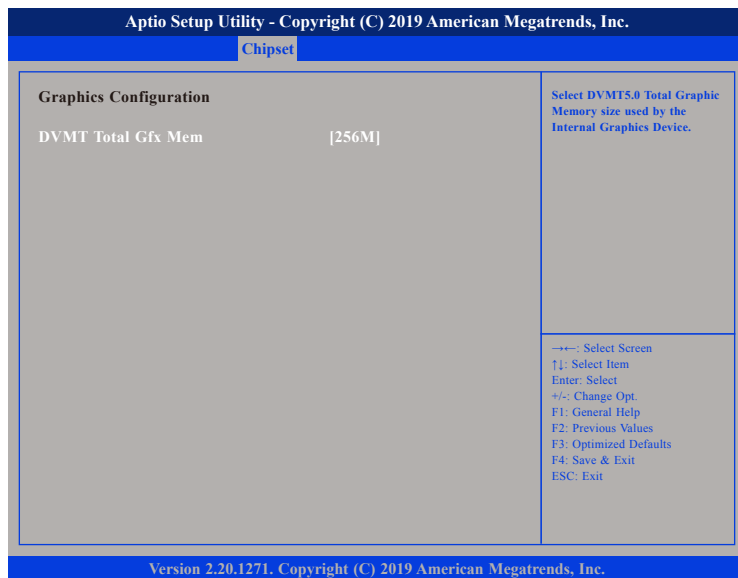

DVTM Total Gfx Mem

Selects the DVTM5.0 Total Graphic Memory size used by the Internal Graphics Device.

PCH-IO Configuration

This section is used to configure PCH-IO configuration.



State After G3

Configures the power state when power is re-applied after a power failure (G3 state).

USB2.0 Power State in Standby

Configures the USB 2.0 power state in standby mode.

USB3.0 Power State in Standby

Configures the USB 3.0 power state in standby mode.

Front USB Power State in Standby

Configures the front USB power state in standby mode.

LAN1(UP)

Enables or disables the top LAN1 controller.

LAN1(DOWN)

Enables or disables the bottom LAN1 controller.

M.2 and MINIPCIE

Enables or disables the M.2 or mini-PCIe slots.

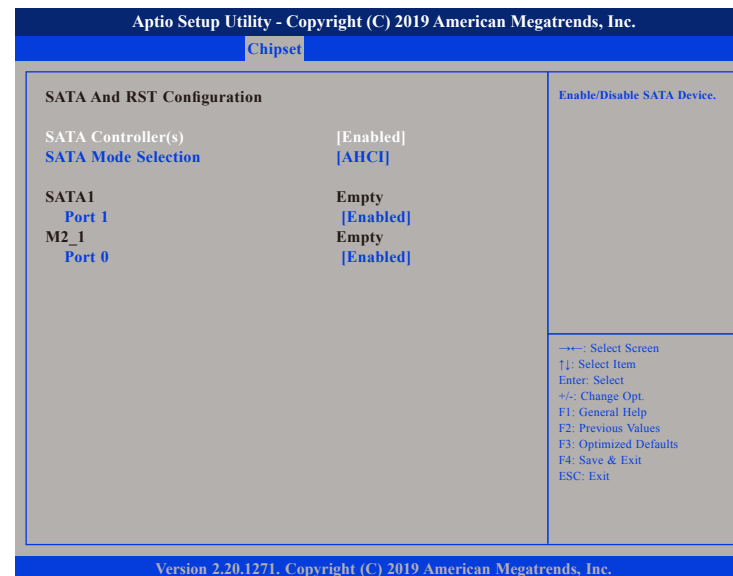
SATA And RST Configuration**SATA Controller(s)**

Enables or disables SATA device.

SATA Mode Selection

Configures the SATA controller as AHCI mode or Intel RST Premium mode.

Port 1 (SATA1)

Enables or disables SATA port 1.

Port 0 (M2_1)

Enables or disables the M.2 slot.

Security Configuration



RTC Lock

Enables or disables bytes 38h-3Fh in the upper and lower 128-byte bank of RTC RAM.

Security

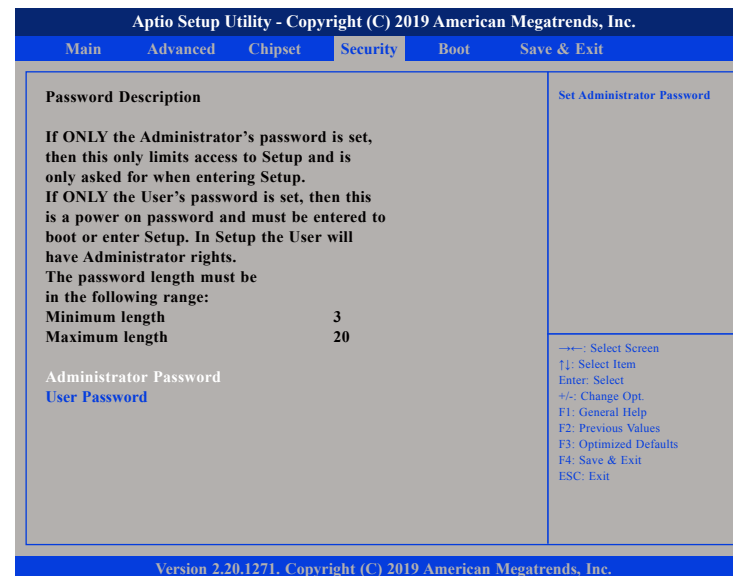

Administrator Password

Select this to reconfigure the administrator's password.

User Password

Select this to reconfigure the user's password.

Boot



Setup Prompt Timeout

Selects the number of seconds to wait for the setup activation key. 65535(0xFFFF) denotes indefinite waiting.

Bootup NumLock State

This allows you to determine the default state of the numeric keypad. By default, the system boots up with NumLock on wherein the function of the numeric keypad is the number keys. When set to Off, the function of the numeric keypad is the arrow keys.

Quiet Boot

Enabled Displays OEM logo instead of the POST messages.
Disabled Displays normal POST messages.

Boot Option Priorities

Adjusts the boot sequence of the system. Boot Option #1 is the first boot device that the system will boot from, next will be #2 and so forth.

Fast Boot

Enables or disables fast boot technology to speed up the system boot time. This is achieved by skipping specific tests during BIOS POST routine.

Save & Exit



Save Changes and Exit

To save the changes and exit the Setup utility, select this field then press <Enter>. A dialog box will appear. Confirm by selecting Yes. You can also press <F4> to save and exit Setup.

Discard Changes and Exit

To exit the Setup utility without saving the changes, select this field then press <Enter>. You may be prompted to confirm again before exiting. You can also press <ESC> to exit without saving the changes.

Save Changes and Reset

To save the changes and reset, select this field then press <Enter>. A dialog box will appear. Confirm by selecting Yes.

Discard Changes and Reset

To exit the Setup utility and reset without saving the changes, select this field then press <Enter>. You may be prompted to confirm again before exiting.

Save Changes

To save changes and continue configuring the BIOS, select this field then press <Enter>. A dialog box will appear. Confirm by selecting Yes.

Discard Changes

To discard the changes, select this field then press <Enter>. A dialog box will appear. Confirm by selecting Yes to discard all changes made and restore the previously saved settings.

Restore Defaults

To restore the BIOS to default settings, select this field then press <Enter>. A dialog box will appear. Confirm by selecting Yes.

Save as User Defaults

To use the current configurations as user default settings for the BIOS, select this field then press <Enter>. A dialog box will appear. Confirm by selecting Yes.

Restore User Defaults

To restore the BIOS to user default settings, select this field then press <Enter>. A dialog box will appear. Confirm by selecting Yes.

Boot Override

To bypass the boot sequence from the Boot Option List and boot from a particular device, select the desired device and press <Enter>.

Launch EFI Shell from filesystem device

To launch EFI shell from a filesystem device, select this field and press <Enter>.