



NEXCOM International Co., Ltd.

Intelligent Digital Security

IP Camera

NCr-303-VHR

User Manual

CONTENTS

Preface

Copyright	v
Disclaimer	v
Acknowledgements	v
Regulatory Compliance Statements	v
Declaration of Conformity	v
RoHS Compliance	vi
Safety Information	vii
Installation Recommendations	vii
Safety Precautions	viii
Technical Support and Assistance	ix
Conventions Used in this Manual	ix
Package Contents	x

Chapter 1: Product Introduction

Overview	1
Key Features	1
Hardware Specifications	2
D/I/O & Function Description	4
D/I/O Pin Definition & Waterproof Connector Description	4
Cable Wiring Description	5
Cable Outlet Description	6
Hardware Installation	6

Chapter 2: Camera Configuration

Accessing the Camera's Configuration Menu (Graphical User Interface) ..	8
Installing IP-FINDER	8

IP-FINDER	11
Web Browser (Internet Explorer)	13
Configuring the Camera's Setting	14
Browsing Through the Configuration Menu	15
Video	16
Video Stream	16
Stream 1	16
Stream 2	17
Stream 3	17
Camera Settings	18
Image Adjustments	18
Mirror & Flip	19
Wide Dynamic Range (WDR)	19
Camera Settings Cont.	20
White Balance	20
Exposure	20
Day & Night	21
Overlay Settings	22
Contents	22
Privacy Mask	23
Settings	23
Mask Zones	24
Network	25
TCP/IP	25
IP Address Configuration	25
Current Network Settings	25
FTP	26
FTP Server	26

Login Information	26	Time Settings	38
Test Remote FTP Server.....	26	Date & Time Format.....	39
SMTP.....	27	NTP Server	39
SMTP Server.....	27	Firmware Upgrade.....	40
Login Information	27	Firmware Version	40
To Mail Address.....	27	Update.....	40
Ports.....	28	Maintenance	41
HTTP.....	28	Maintain	41
RTSP	28	Camera Name Settings.....	41
Events.....	29	Advanced Settings.....	42
Motion Detection	29	Video.....	43
Settings.....	29	Camera Settings (Advanced).....	43
Detection Zones.....	30	Chroma & Sharpness Suppression	43
Alarm In/Out Trigger.....	31	Manual White Balance	43
Alarm In Control	31	Manual Exposure & Gain	43
Alarm Out Control	31	Camera Settings (Advanced) Cont.	44
Event Actions	32	Auto Exposure Configuration	44
When Motion Detection Triggered	32	P-Iris Control	44
When Alarm In Triggered	32	IR Cut Filter (ICR) Control	44
System.....	34	IR LED Control.....	45
Audio.....	34	Gamma Control.....	45
Audio Settings	34	ROI.....	46
Recording Settings.....	35	Auto Exposure Weights	47
AVI File Setting.....	35	Network	48
User Management.....	36	DDNS	48
Add/Modify User Accounts.....	36	DDNS Settings.....	48
User List.....	36	SNMP	49
SD Card Management.....	37	SNMP v1/v2	49
SD Card Information	37	Traps for SNMP v1/v2	49
File List.....	37	SNMP v3	49
Date & Time	38	Multicast	50
Current Camera Time.....	38	Settings.....	50

- Events 51
 - Ethernet Lost Detection 51
 - Settings..... 51
 - Face Detection..... 52
 - Tampering Detection 53
 - Settings..... 53
 - Event Actions (Advanced) 54
 - When Motion Detection Triggered 54
 - When Tampering Detection Triggered..... 54
- System..... 55
 - Schedule Recording 55
 - Schedule Recording Setting..... 55

Chapter 3:
Viewing Live Video via VLC Media Player.....56

PREFACE

Copyright

This publication, including all photographs, illustrations and software, is protected under international copyright laws, with all rights reserved. No part of this manual may be reproduced, copied, translated or transmitted in any form or by any means without the prior written consent from NEXCOM International Co., Ltd.

Disclaimer

The information in this document is subject to change without prior notice and does not represent commitment from NEXCOM International Co., Ltd. However, users may update their knowledge of any product in use by constantly checking its manual posted on our website: <http://www.nexcom.com>. NEXCOM shall not be liable for direct, indirect, special, incidental, or consequential damages arising out of the use of any product, nor for any infringements upon the rights of third parties, which may result from such use. Any implied warranties of merchantability or fitness for any particular purpose is also disclaimed.

Acknowledgements

NCR-303-VHR is a trademark of NEXCOM International Co., Ltd. All other product names mentioned herein are registered trademarks of their respective owners.

Regulatory Compliance Statements

This section provides the FCC compliance statement for Class B devices and describes how to keep the system CE compliant.

Declaration of Conformity

FCC

This equipment has been tested and verified to comply with the limits for a Class B digital device, pursuant to Part 15 of FCC Rules. These limits are designed to provide reasonable protection against harmful interference when the equipment is operated in a commercial environment. This equipment generates, uses, and can radiate radio frequency energy and, if not installed and used in accordance with the instructions, may cause harmful interference to radio communications. Operation of this equipment in a residential area (domestic environment) is likely to cause harmful interference, in which case the user will be required to correct the interference (take adequate measures) at their own expense.

CE

The product(s) described in this manual complies with all applicable European Union (CE) directives if it has a CE marking. For computer systems to remain CE compliant, only CE-compliant parts may be used. Maintaining CE compliance also requires proper cable and cabling techniques.

RoHS Compliance



NEXCOM RoHS Environmental Policy and Status Update

NEXCOM is a global citizen for building the digital infrastructure. We are committed to providing green products and services, which are compliant with European Union RoHS (Restriction on Use of Hazardous Substance in Electronic Equipment) directive 2011/65/EU, to be your trusted green partner and to protect our environment.

RoHS restricts the use of Lead (Pb) < 0.1% or 1,000ppm, Mercury (Hg) < 0.1% or 1,000ppm, Cadmium (Cd) < 0.01% or 100ppm, Hexavalent Chromium (Cr6+) < 0.1% or 1,000ppm, Polybrominated biphenyls (PBB) < 0.1% or 1,000ppm, and Polybrominated diphenyl Ethers (PBDE) < 0.1% or 1,000ppm.

In order to meet the RoHS compliant directives, NEXCOM has established an engineering and manufacturing task force to implement the introduction of green products. The task force will ensure that we follow the standard NEXCOM development procedure and that all the new RoHS components and new manufacturing processes maintain the highest industry quality levels for which NEXCOM are renowned.

The model selection criteria will be based on market demand. Vendors and suppliers will ensure that all designed components will be RoHS compliant.

How to recognize NEXCOM RoHS Products?

For existing products where there are non-RoHS and RoHS versions, the suffix "(LF)" will be added to the compliant product name.

All new product models launched after January 2013 will be RoHS compliant. They will use the usual NEXCOM naming convention.

Warnings

Read and adhere to all warnings, cautions, and notices in this guide and the documentation supplied with the chassis, power supply, and accessory modules. If the instructions for the chassis and power supply are inconsistent with these instructions or the instructions for accessory modules, contact the supplier to find out how you can ensure that your computer meets safety and regulatory requirements.

Cautions

Electrostatic discharge (ESD) can damage system components. Do the described procedures only at an ESD workstation. If no such station is available, you can provide some ESD protection by wearing an antistatic wrist strap and attaching it to a metal part of the computer chassis.

Safety Information

Before installing and using the device, note the following precautions:

- Read all instructions carefully.
- Do not place the unit on an unstable surface, cart, or stand.
- Follow all warnings and cautions in this manual.
- When replacing parts, ensure that your service technician uses parts specified by the manufacturer.
- Avoid using the system near water, in direct sunlight, or near a heating device.
- The load of the system unit does not solely rely for support from the rackmounts located on the sides. Firm support from the bottom is highly necessary in order to provide balance stability.
- The network camera is provided with a battery-powered real-time clock circuit. There is a danger of explosion if battery is incorrectly replaced. Replace only with the same or equivalent type recommended by the manufacturer. Discard used batteries according to the manufacturer's instructions.

Installation Recommendations

Ensure you have a stable, clean working environment. Dust and dirt can get into components and cause a malfunction. Use containers to keep small components separated.

Adequate lighting and proper tools can prevent you from accidentally damaging the internal components. Most of the procedures that follow require only a few simple tools, including the following:

- A Philips screwdriver
- A flat-tipped screwdriver
- A grounding strap
- An anti-static pad

Using your fingers can disconnect most of the connections. It is recommended that you do not use needle-nose pliers to disconnect connections as these can damage the soft metal or plastic parts of the connectors.

Safety Precautions

1. Read these safety instructions carefully.
2. Keep this User Manual for later reference.
3. Disconnect this equipment from any power sources before cleaning. Use a damp cloth. Do not use liquid or spray detergents for cleaning.
4. For plug-in equipment, the power outlet socket must be located near the equipment and must be easily accessible.
5. Keep this equipment away from humidity.
6. Put this equipment on a stable surface during installation. Dropping it or letting it fall may cause damage.
8. Make sure the voltage of the power source is correct before connecting the equipment to the power source.
10. All cautions and warnings on the equipment should be noted.
11. If the equipment is not used for a long time, disconnect it from the power source to avoid damage by transient overvoltage.
12. Never pour any liquid into an opening. This may cause fire or electrical shock.
13. Never open the equipment. For safety reasons, the equipment should be opened only by qualified service personnel.
14. If one of the following situations arises, get the equipment checked by service personnel:
 - a. The power cord or plug is damaged.
 - b. Liquid has penetrated into the equipment.
 - c. The equipment has been exposed to moisture.
 - d. The equipment does not work well, or you cannot get it to work according to the user's manual.
 - e. The equipment has been dropped and damaged.
 - f. The equipment has obvious signs of breakage.
15. Do not place heavy objects on the equipment.
17. CAUTION: DANGER OF EXPLOSION IF BATTERY IS INCORRECTLY REPLACED. REPLACE ONLY WITH THE SAME OR EQUIVALENT TYPE RECOMMENDED BY THE MANUFACTURER. DISCARD USED BATTERIES ACCORDING TO THE MANUFACTURER'S INSTRUCTIONS.

Technical Support and Assistance

1. For the most updated information of NEXCOM products, visit NEXCOM's website at www.nexcom.com.
2. For technical issues that require contacting our technical support team or sales representative, please have the following information ready before calling:
 - Product name and serial number
 - Detailed information of the peripheral devices
 - Detailed information of the installed software (operating system, version, application software, etc.)
 - A complete description of the problem
 - The exact wordings of the error messages

Warning!

1. Handling the unit: carry the unit with both hands and handle it with care.
2. Maintenance: to keep the unit clean, use only approved cleaning products or clean with a dry cloth.

Conventions Used in this Manual



Warning:

Information about certain situations, which if not observed, can cause personal injury. This will prevent injury to yourself when performing a task.



Caution:

Information to avoid damaging components or losing data.



Note:

Provides additional information to complete a task easily.

Package Contents

The 3MP Outdoor IR Bullet Camera package contains the following accessories:

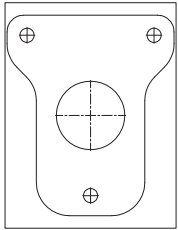

Placement sticker



Quick guide



Dehumidifier packet



Mounting accessory kit

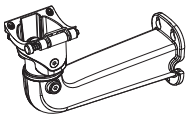

2-axis cable concealed wall mount bracket

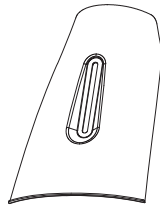

Sunshield



Waterproof connector

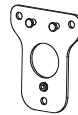

Wall mount base

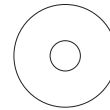

CD (User Manual)

CHAPTER 1: PRODUCT INTRODUCTION

Overview



Key Features

- Progressive scan CMOS sensor at 3 megapixel/1080p full HD resolution
- Multiple H.264 and MJPEG streams
- Easy installation with remote focus and zoom control
- Support Auto-Focus to avoid focus error through human eyes
- Adjustable P-iris to achieve best image quality
- Perfect IR exposure calculation
- WDR [Wide Dynamic Range] to overcome high contrast lighting environment
- Outdoor-ready, IP66/IP67
- Active tampering alarm
- Impact-resistant for IK10
- Excellent low light noise reduction
- ONVIF support
- Extreme weather support (-40°C to 60°C)

Hardware Specifications

Camera

- Image sensor: 1/3" 3 megapixel true WDR progressive scan CMOS sensor
- Lens: Motorized (9-22mm, F1.5) board type
- Iris type: p-iris
- Day and night: Yes
- IR distance: Effective up to 50 meters
- IR wavelength: 850nm (4pcs high power LED)
- IR control: Smart IR
- ICR: Yes
- WDR: Yes
- Image Enhancement
 - Brightness, Contrast, Saturation, Sharpness, Backlight compensation, Mirror, Flip, Day/Night, Anti-flicker

Video

- Video compression: H.264/MJPEG
- Video streaming: triple streaming
 - H.264 Stream 1/ H.264 Stream 2/ MJPEG Stream 3
- Video resolution: 2048 x 1536 to 320 x 240
- Video quality
 - VBR
 - CBR
- Frame rate
 - 2048 x 1536 @ 30 fps
 - 1920 x 1080 @ 60 fps
 - 1280 x 720 @ 60 fps
 - 720 x 576 @ 60 fps
 - 720 x 480 @ 60 fps
 - 640 x 480 @ 60 fps
 - 320 x 240 @ 60 fps

Audio

- Audio streaming: Two-way
- Audio compression: G.711 8KHz/ 16bit
- Audio input: Line-in
- Audio output: Line-out

Network

- Interface: 10/100/1000 Mbps Ethernet, RJ-45
- Supported protocols: HTTP, TCP/IP, UDP, RTP, RTSP, FTP, SMTP, DHCP, DNS, DDNS, NTP, uPnP, ONVIF, IPv4/ v6
- Security: Multi-level passwords/ HTTP encryption

I/O Connector

- Audio in/ out port: Terminal block 1 in/ 1 out
- D I/O: DI x1, DO x1
- RS485: N/A
- Micro SD slot: Yes
- RJ45: Yes

Event Management

- Event trigger: Motion detection, DI
- Notifications: Trigger alarm output, email/ FTP and record video to server or SD card
- Post-recording: Yes
- Pre-recording: Yes

Power

- DC: DC 12V/ AC 24V
- PoE: Yes/ IEEE 802.3at

General

- Power consumption: 21W max.
- Weight: 2kg
- Dimension: 406.22(D) x 161(W) x 263.3(H) mm
- Operating Temp.: -40°C~60°C
- Humidity: 90% RH (no condensation)
- Certification: CE/FCC
- Vandal resistant: IK10
- Outdoor capable: IP66/IP67, built-in heater
- Application: SDK available for application development

DI/O & Function Description

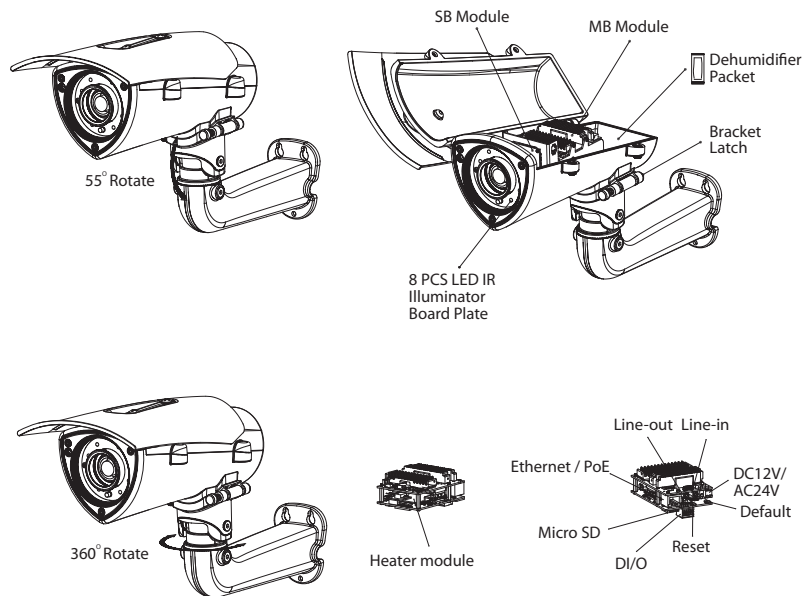

Note:

Default: If the default button has been pressed for 1~4 seconds, the camera will be re-started and all the settings will be reverted to default except IP address. If pressed for over 5 seconds, the camera will be re-started and all the settings will be reverted to default including IP address.

Reset: Press to reset the camera.

DI/O Pin Definition & Waterproof Connector Description

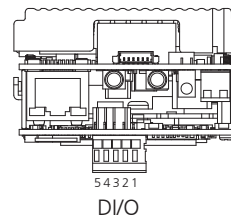

Pin	Description
1	ALM_IN (+)
2	ALM_IN (-)
3	ALM_out_NC
4	ALM_out_COM
5	ALM_out_NO

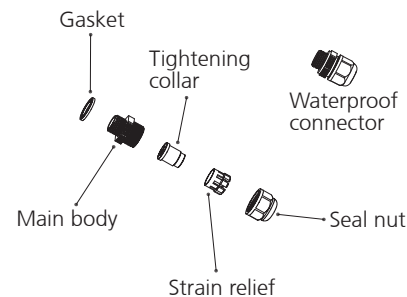

Cable Wiring Description

1. Cable Installation Steps:
2. Run the cable inside the wall mount bracket and out through the cable opening at the front.
3. Press down the push-lock mechanism and secure the camera onto the push-lock. Wire the network cables to the waterproof connector on the right, and wire the line-in, line-out, DC 12V/AV 24V, DVO and other cables to the waterproof connector on the left. Tighten the waterproof connector after all the cables are secured in place.
4. Secure the camera onto the wall mount bracket using the two screws provided.
5. Open the camera's top cover to access the wired cables. Install the RJ45 connector to the Ethernet cable and plug it into the corresponding port on the MB module.
6. Close the camera's top cover and secure it with the supplied hardware tool to complete.

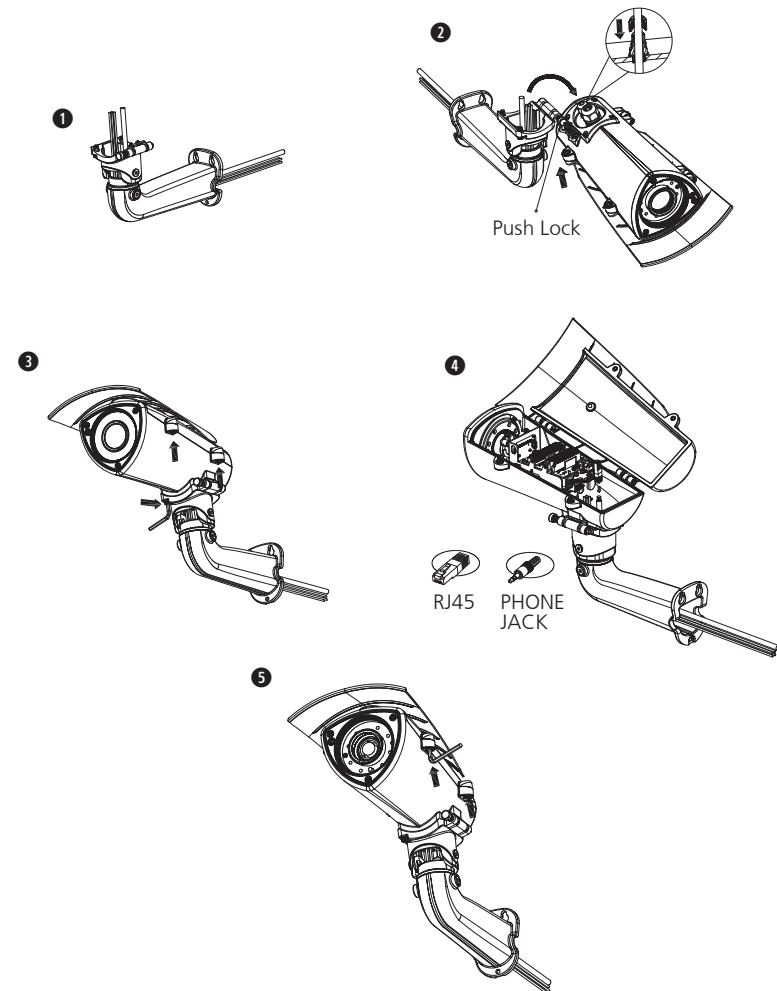

Cable Outlet Description

1. The camera features two waterproof connectors, the left one in the diagram is for PoE connection, while right one is for line in, line out, DC 12V/AC 24V and DI/O connections.
2. The right one features four wire holes. Please cover unused holes with sealing plugs to prevent water from entering.
3. Applicable cable diameter:
4. * \varnothing 2.5~1.8mm (Right)
5. * \varnothing 6.9~4.7mm (Left)

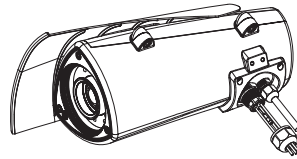
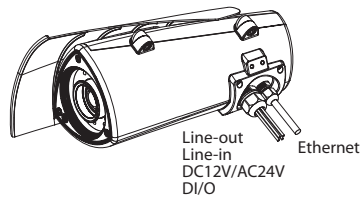

Hardware Installation

1. Position the placement sticker at the desired installation location and use a driller to drill the three holes on the sticker.
2. Insert three screw anchors into the holes then place the wall mount base on top of them with the mounting holes aligned.
3. Open the camera's cover and glue the dehumidifier packet onto the metal bracket using the adhesive sticker on its back, as depicted in the diagram below. Close the camera's cover and ensure the clip is locked in position. Install the sunshield and tighten a torx screw on the side of cover.

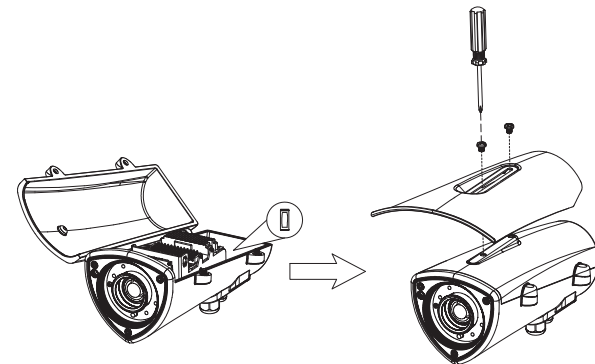
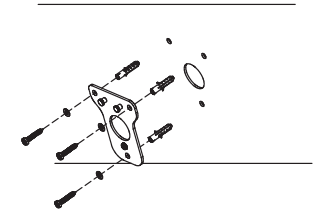
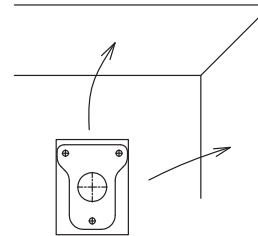

4. Secure the connecting bracket to the camera's rear.

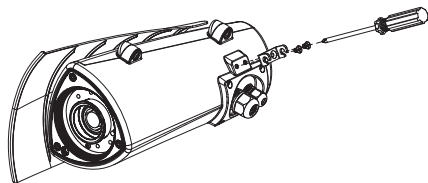

5. Press and hold down the latch on the wall mount bracket and put it into the connecting bracket. Once in place, secure the other side using the supplied hex wrench.

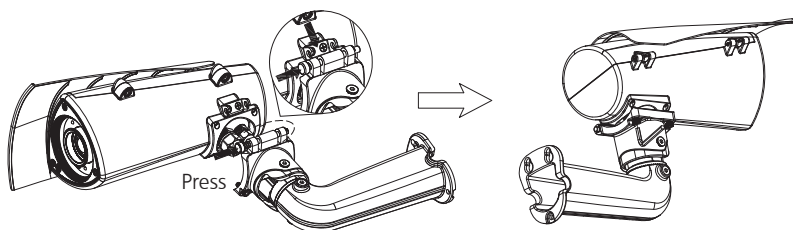

6. Align the mounting holes on the wall mount bracket to the mounting holes on the wall mount plate, then secure it tightly with screws to finish the installation.

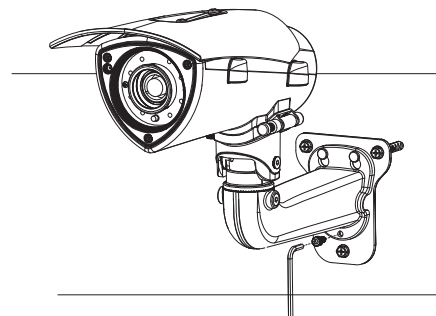

CHAPTER 2: CAMERA CONFIGURATION

Accessing the Camera's Configuration Menu (Graphical User Interface)

The camera's default IP address is 192.168.1.168, make sure the IP address of the computer accessing the camera is on the same network subnet before proceeding.

You can access the camera via a web browser or IP-FINDER software included with the camera. The following information outlines the instructions for each method.

Installing IP-FINDER



Note: If IP-FINDER is already installed, you can skip this section and continue to the next section **IP-FINDER** on page 11.

1. Locate the installation file **IP-FINDER-Setup.msi** on the CD.
2. Once located, double click on the file to start the installation program.
3. Click the **Next** button on the welcome screen to continue.

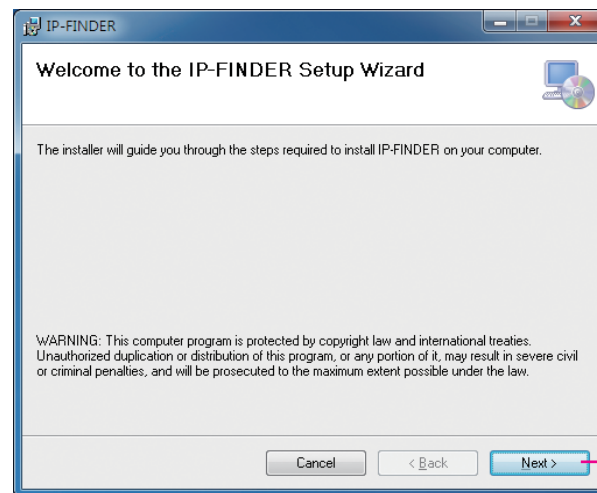

Next button

4. Confirm the directory that the program will be installed on. To specify a different folder, please click on the **Browse** button and locate the desired installation folder.

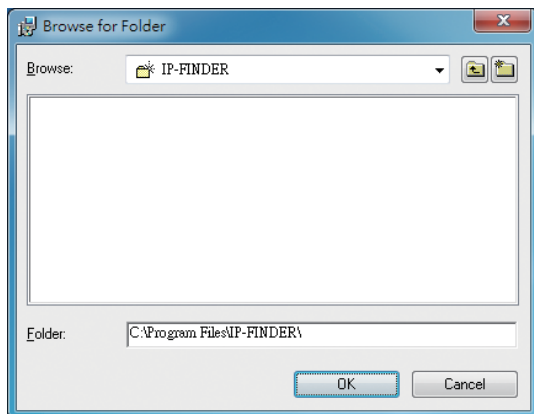

5. To check the available drives you can install the software to and their available and required disk space, please click on the **Disk Cost** button.

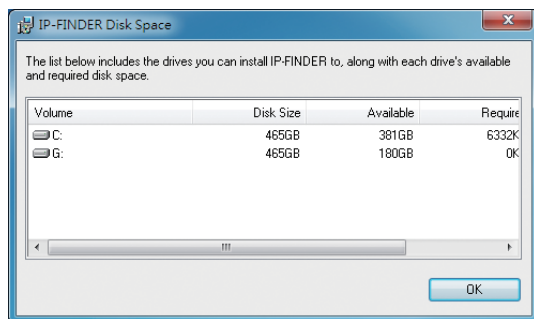

6. Specify which user accounts on the computer can access the program, the options are **Everyone** and **Just me**.

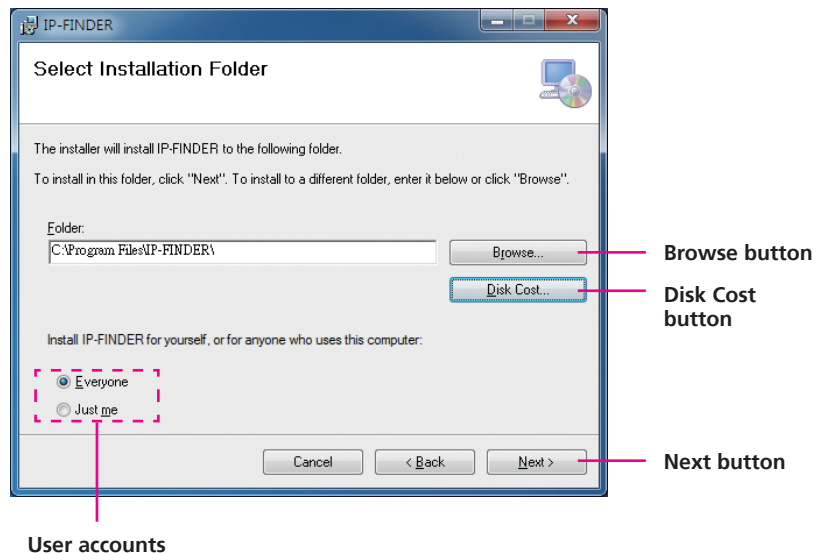

7. Click on the **Next** button to continue.

8. Click on the **Next** button to begin installation.

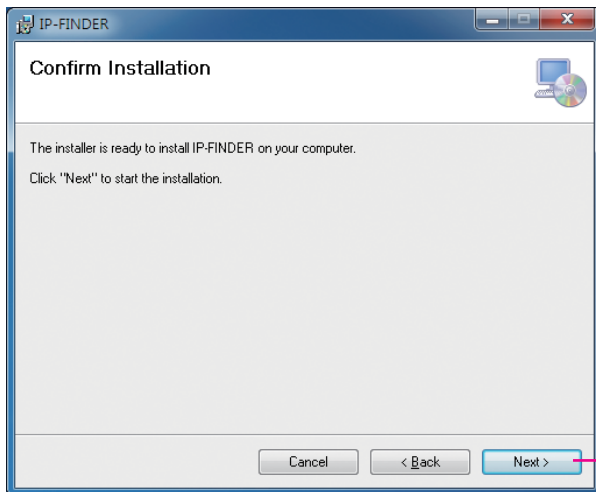

Next button

9. Once the installation process is complete, click on the **Close** button to finish. A shortcut will be created on the desktop.

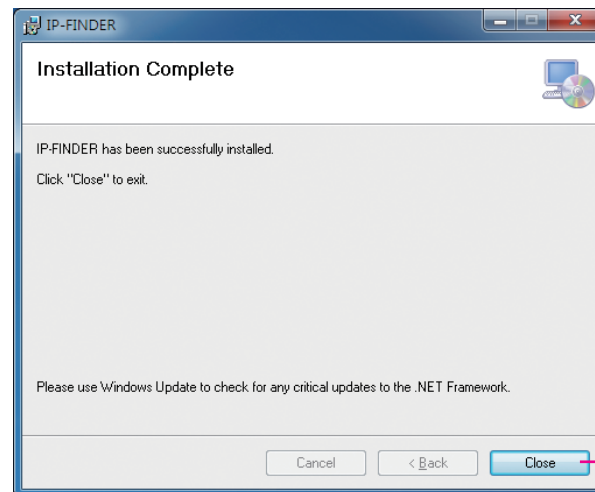

Close button

IP-FINDER

1. Locate and open the IP-FINDER software shortcut on the desktop.



2. When the program is launched, it will begin searching the network for the IP camera automatically (the search will last for up to 90 seconds). You can also manually search cameras by clicking on the **Search** button.

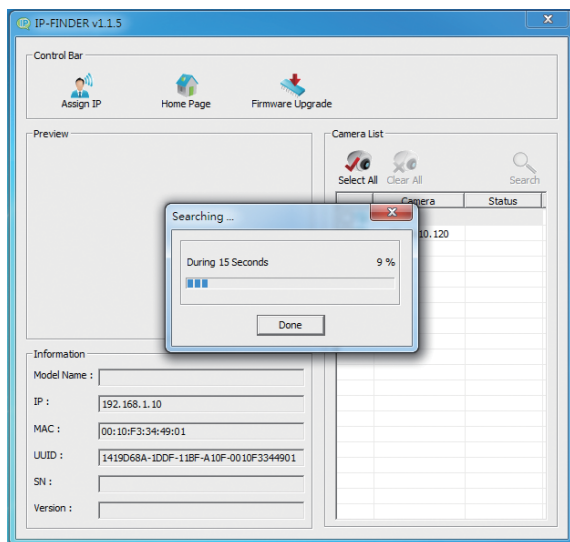

Note: Manual search will last for up to 90 seconds.

3. Once the camera is discovered, it will show the following information:

- Model name
- IP address
- MAC address
- UUID
- Serial number
- Version

4. Click on the **Home Page** button and it will launch the camera's configuration menu via Internet Explorer. You can also access the menu by double clicking the camera's **IP address** under **Camera List**.

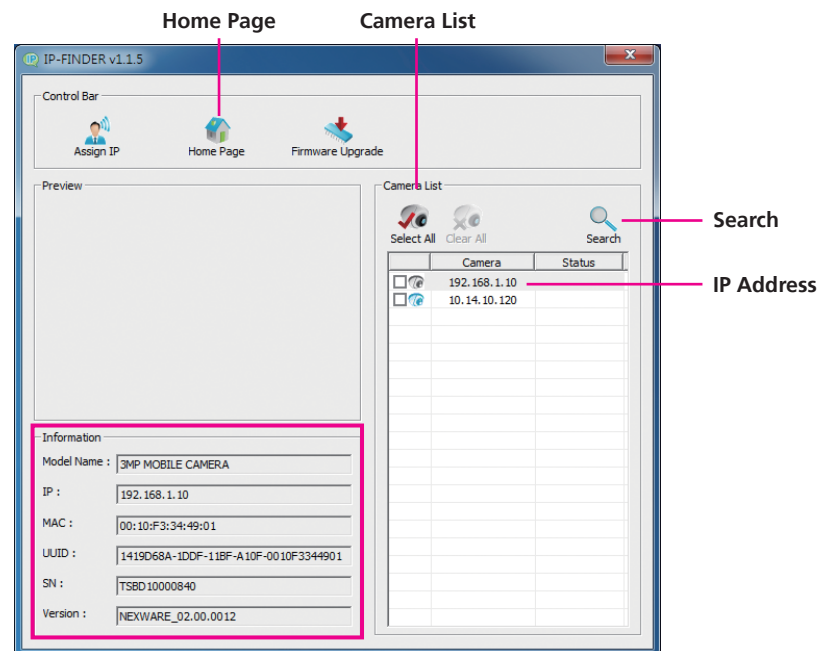

Multiple Cameras

If more than one IP camera are detected, the **Camera List** will show all the available cameras on the network. To access all the cameras' configuration menu simultaneously, click on the **Select All** button to select all the cameras in the list, then click the **Home Page** button. Similarly, you can access specific ones by ticking the camera's checkbox.

To deselect, press the **Clear All** button to remove all the selection, or specific ones by unchecking the checkbox.

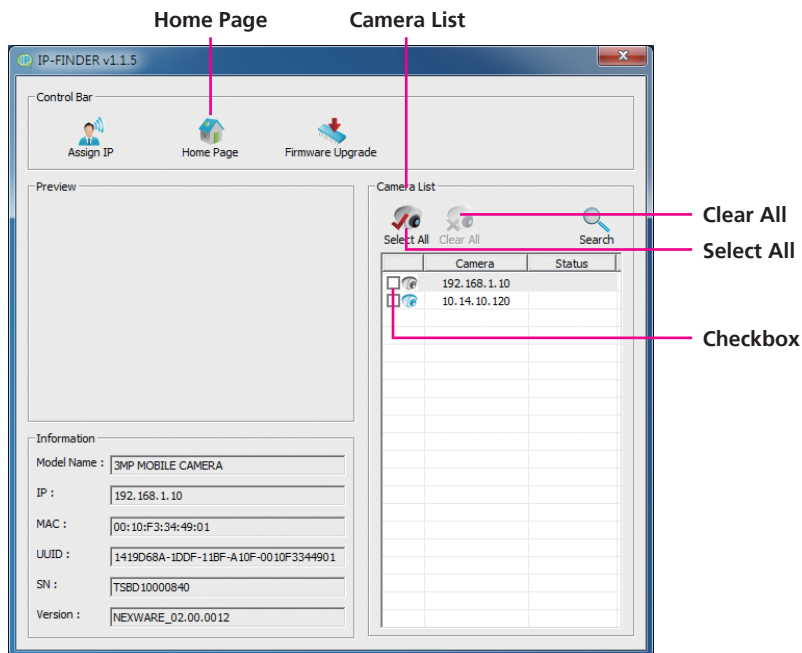

Web Browser (Internet Explorer)

1. Locate and open the Internet Explorer (IE) shortcut on the desktop.
2. In the address bar, type 192.168.1.168 (default IP address of the camera) and then press the **Enter** button.
3. You will be prompted with a pop-up window asking for login information, type in **"admin"** (default login name) and **"9999"** (default password)
4. Once logged in, you will see the main screen with video stream [stream 3]

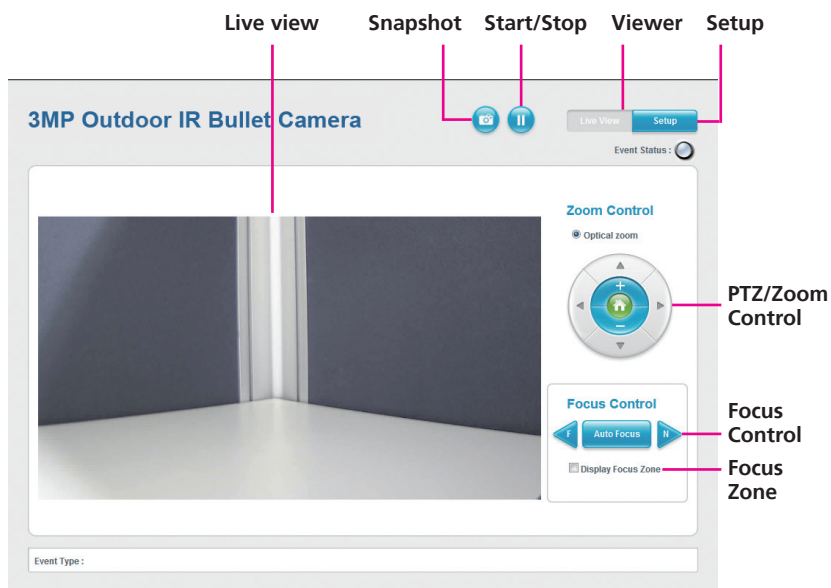

Snapshot

Takes a image snapshot from the camera, you will be prompted to store the image file onto the computer's hard drive.

Start/Stop

Press to stop the live video, press again to restart.

Viewer

Views the live video of the camera.

Setup

Options for configuring the IP camera.

PTZ/Zoom Control

Buttons used to control zooming and PTZ function.

Button	Description
	Moves the camera up, down, left and right.
	Returns the camera back to default position.
	Adjusts the camera to zoom in or out.

Focus Control

Adjusts the camera's focus. To adjust the focus automatically, press the **Auto Focus** button. To set the focus manually, press the to focus far objects, and to focus near objects.

Focus Zone

Enables or disables display of focus zone in the center of the live view (cross-hair).

Configuring the Camera's Setting

1. To configure the camera's setting, click on the **Setup** button on the main screen to enter the configuration menu.

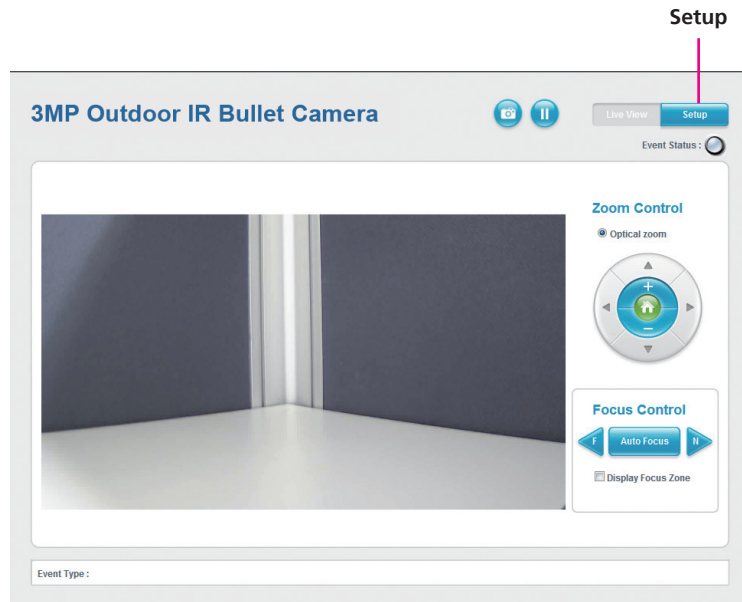

Browsing Through the Configuration Menu

The layout of the configuration menu is split into two sections. All the camera settings are located on the left hand side of the interface, clicking it will open their corresponding sub-menu on the right.

3MP Outdoor IR Bullet Camera Live View Setup

Basic Settings

- Video
 - Video Stream
 - Camera Settings
 - Overlay Settings
 - Privacy Mask
- Network
 - TCP/IP
 - FTP
 - SMTP
 - Ports
- Events
 - Motion Detection
 - Alarm In/Out Trigger
 - Event Actions
- System
 - Audio Settings
 - Recording Settings
 - User Management
 - SD Card Management
 - Date & Time
 - Firmware Upgrade
 - Maintenance

Video Stream Settings

Stream-1

H.264
 Resolution : 1920x1080 (16:9)
 FrameRate : 30 fps (Range = 5-60fps)
 Bit Rate Control : VBR CBR
 Target bit rate : 10000 kbit/s (Range = 30-20000 kbit/s)
 GOP Length : 1 seconds

Stream-2

H.264
 Resolution : 720x480 (3:2)
 FrameRate : 15 fps (Range = 0-30fps / Stream off = 0)
 Bit Rate Control : VBR CBR
 Target bit rate : 2000 kbit/s (Range = 30-10000 kbit/s)
 GOP Length : 1 seconds

Stream-3

MJPEG
 Resolution : 1280x720 (16:9)
 FrameRate : 10 fps (Range = 0-30fps / Stream off = 0)
 Quality : Good

Save Reset

The following are the camera settings available on the left hand side:

- Video
 - Video Stream
 - Camera Settings
 - Overlay Settings
 - Privacy Mask
- Network
 - TCP/IP
 - FTP
 - SMTP
 - Ports
- Events
 - Motion Detection
 - Alarm In/Out Trigger
 - Event Actions
- System
 - Audio Settings
 - Recording Settings
 - User Management
 - SD Card Management
 - Date & Time
 - Firmware Upgrade
 - Maintenance
- Advanced Settings

Video

Video Stream

This section configures the settings of the video stream. There are 3 video streams available, the live video from the main screen **Viewer** is stream 1.

Video Stream Settings

Stream-1

H.264

Resolution : 1920x1080 (16:9) ▾

FrameRate : 30 fps (Range = 5~30fps)

Bit Rate Control :

 VBR CBR

Target bit rate : 10000 kbit/s (Range = 30~20000 kbit/s)

GOP Length : 1 ▾ seconds

Stream-2

H.264

Resolution : 720x480 (3:2) ▾

FrameRate : 15 fps (Range = 0~30fps / Stream off = 0)

Bit Rate Control :

 VBR CBR

Target bit rate : 2000 kbit/s (Range = 30~10000 kbit/s)

GOP Length : 1 ▾ seconds

Stream-3

MJPEG

Resolution : 1280x720 (16:9) ▾

FrameRate : 10 fps (Range = 0~30fps / Stream off = 0)

Quality :

Good ▾

Save

Reset

Stream 1

Resolution

Configures the resolution of the video stream. The options are **2048x1536 (4:3)** and **1920x1080 (16:9)**.

FrameRate

Adjusts the frame rate of the video stream, the range is 5~30FPS.

Bit Rate Control

Configures the Bit Rate Control mode as **VBR** (variable bit rate), or **CBR** (constant bit rate) for the stream.

Target Bit Rate

If the Bit Rate Control is set to **CBR**, you can manually set the bit rate in this field, the range is 30~20000kbit/s.

GOP Length

Configures the GOP length of the stream. The options are **0.5, 1, 2, 3** and **4**, setting "**0.5 seconds**" will yield the best video quality.

Stream 2

Resolution

Configures the resolution of the video stream. The available options are **1280x720(16:9)**, **720x480(3:2)**, **720x576(5:4)**, **640x480(4:3)** and **320x240(4:3)**.

FrameRate

Adjusts the frame rate of the video stream. Setting **0** will disable the stream.

Bit Rate Control

Configures the Bit Rate Control mode as **VBR** (variable bit rate), or **CBR** (constant bit rate) for the stream.

Target Bit Rate

If the Bit Rate Control is set to **CBR**, you can manually set the bit rate in this field, the range is 30~10000kbit/s.

GOP Length

Configures the GOP length of the stream. The options are **0.5**, **1**, **2**, **3** and **4**, setting "**0.5 seconds**" will yield the best video quality.

Stream 3

Resolution

Displays the resolution of the video stream.

FrameRate

Adjusts the frame rate of the video stream. Setting **0** will disable the stream.

Quality

Configures the video quality of the stream. The options are **Best**, **Good** and **Normal**.

Save

Save button to apply the configurations, click on this button once all the settings are confirmed for the new changes to take effect.

Reset

Reset button to discard all the settings applied.

Camera Settings

This section adjusts the camera's image settings.

Camera Settings

Quick viewer

Image Adjustment

Brightness : 128 (Range = 0~255)

Contrast : 128 (Range = 0~255)

Color Saturation : 128 (Range = 0~255)

Sharpness : 128 (Range = 0~255)

Default

Mirror & Flip

Enable mirror

Enable flip

Wide Dynamic Range (WDR)

WDR mode : ▾

Schedule WDR :

Start time : : End time : : Use mode : ▾

Please set the non-specified time range, use mode : ▾

White Balance

White balance mode : ▾

Image Adjustments

Brightness

Configures the brightness of the image, the range is 0 ~ 255, with 0 being the lowest brightness. Press the < button to decrease the value, or > button to increase the value. The default value is 128.

Contrast

Configures the contrast of the image, the range is 0 ~ 255, with 0 being the lowest contrast. Press the < button to decrease the value, or > button to increase the value. The default value is 128.

Color Saturation

Configures the color saturation of the image, the range is 0 ~ 255, with 0 being the lowest saturation. Press the < button to decrease the value, or > button to increase the value. The default value is 128.

Sharpness

Configures the sharpness of the image, the range is 0 ~ 255, with 0 being the lowest sharpness. Press the < button to decrease the value, or > button to increase the value. The default value is 128.

Default

Default button to discard all the settings applied to Image Adjustments.

QuickViewer

Click this button to open up a small preview window of the live video, you can view the image as you make image adjustments. Click the **Save** button for the changes to take effect.

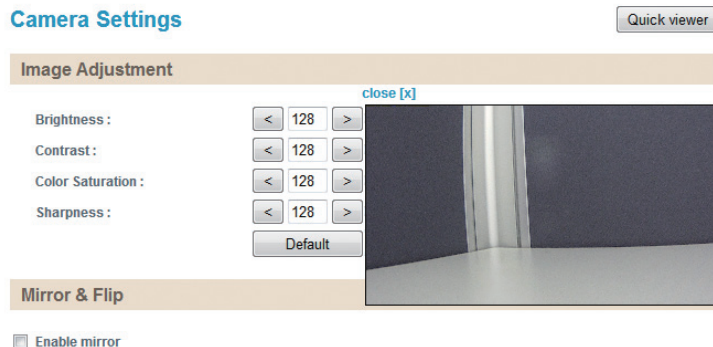

Mirror & Flip

Enable Mirror

Flip the camera image horizontally.

Enable Flip

Flip the camera image vertically.

Wide Dynamic Range (WDR)

WDR Mode

Enables or disables WDR function, enable this option if the camera is exposed to bright backlight, glare or high contrast lighting. You can specify the WDR contrast level as **low**, **middle** or **high**. Selecting **high** will produce the best image quality.

Schedule WDR

Enables or disables WDR function to activate at the specified time. You can configure the **Start Time** and **End Time** in 24-hour format.

Use Mode (During Scheduled Hours)

Selects the WDR contrast level to use during the scheduled time.

Use Mode (Outside of the Scheduled Hours)

Selects the WDR contrast level to use outside of the scheduled time.

Camera Settings Cont.

White Balance

White balance mode :

Exposure

Exposure mode :

Exposure value adjust : (Range = 0~255)

Enable slow shutter

Maximum exposure time :

Enable sens up

Maximum sens up gain :

Enable backlight compensation

Day & Night

Auto

Forced color

Forced black & white

Schedule Day & Night :

Start time : : End time : : Use mode :

Please set the non-specified time range, use mode :

Save

Reset

White Balance

White Balance Mode

Enables or disables the white balance function on the camera. White balance allows the camera to produce more accurate colors under different lighting conditions. The following modes can be selected:

- Off: Disables white balance function.
- Auto: Automatically adjusts the white balance to suit the current lighting condition.
- Fixed Outdoor: Adjusts the white balance for outdoor daylight.
- Incandescent: Adjusts the white balance for indoor light.
- Fluorescent: Adjusts the white balance for fluorescent light.

Exposure

Exposure Mode

This option configures the anti-flickering function of the camera. If the image is suffering from flickering under fluorescent light, selecting **Auto** will allow the camera to automatically adjust the light frequency to match the current fluorescent lighting condition and prevent flickering. You can also manually set it to **Anti-Flicker 50Hz**, **Anti-Flicker 60Hz** or **Locked**.

Exposure Value Adjust

Adjusts the exposure value on the camera, the range is 0 ~ 255. Press the < button to decrease the value, or > button to increase the value. The default value is 128.

Enable Slow Shutter

Enables or disables slow shutter on the camera, you can select the shutter speed in drop the list. The options are **1/7**, **1/15**, **1/30**. Selecting a slower shutter speed will improve image quality in low light conditions, but will increase motion blur.

Enable Sens Up

Enables or disables gain setting on the camera, you can select the maximum level of amplification in the drop down list. The options are **4x**, **8x**, **16x** and **32x**. A higher value will produce brighter images, but may also increase image noise.

Enable Backlight Compensation

Enables or disables backlight compensation function, enable this option if an image in the camera is too dark.

Day & Night

Configures the day and night mode of the camera.

Auto: Allows the camera to automatically sense the current lighting level and determine what type of color range it should display.

Forced Color: Forces the camera to display color regardless of the current lighting level.

Forced Black & White: Forces the camera to display black & white images regardless of the current lighting level.

Schedule Day & Night

Enables day and night mode to activate at the specified time. You can configure the **Start Time** and **End Time** in 24-hour format.

Use Mode (During Scheduled Hours)

Selects the color mode to use during the scheduled time.

Use Mode (Outside of the Scheduled Hours)

Selects the color mode to use outside of the scheduled time.

Save

Save button to apply the configurations, click on this button once all the settings are confirmed for the new changes to take effect.

Reset

Reset button to discard all the settings applied.

Overlay Settings

This section configures the text displayed on the live video in **Viewer**.

Overlay Settings

Contents

Enable date

Enable time

Enable text :

Display Camera Name

Save

Reset

Contents

Enable Date

Enables or disables the **Viewer** to display the current date on the bottom right corner.

Enable Time

Enables or disables the **Viewer** to display the current time on the bottom right corner.

Enable Text

Enables or disables the **Viewer** to display text on the upper right corner. The text displayed can be configured in the field box.

Display Camera Name

Enables or disables the **Viewer** to display the camera's name on the upper left corner. The name displayed can be configured in the **Maintenance** menu. For information on **Maintenance** menu, please refer to page 41.

Save

Save button to apply the configurations, click on this button once all the settings are confirmed for the new changes to take effect.

Reset

Reset button to discard all the settings applied.

Privacy Mask

This section configures which area of the live video in **Viewer** will be masked for privacy. A total of 3 privacy masks can be configured.

Privacy Mask

Settings

Privacy mask color :

Mask Zones

- Enable mask zone 1**
- Enable mask zone 2**
- Enable mask zone 3**

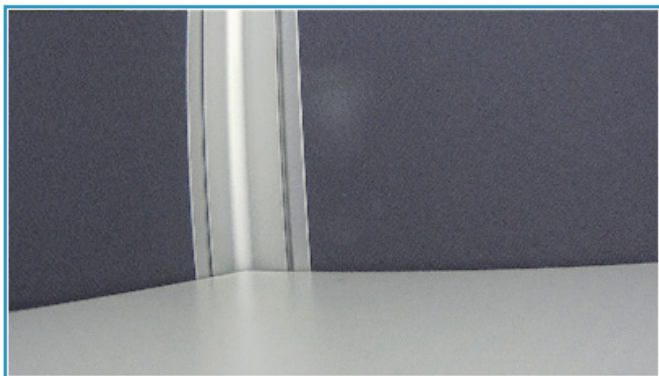

Settings

Privacy Mask Color

Selects the color of the privacy mask. The available colors are **Black** and **White**.

Mask Zones

You can configure up to 3 privacy masks, the instructions below illustrate how to setup 3 privacy masks.

1. Select the color of the mask in the drop down list.
2. To create the first mask, check the **Enable mask zone 1**, and on the live video screen below, select the area to mask by holding down the mouse button and drag to make a rectangular square, release the button once the desired area is covered.
3. Press the **Setting Area** button in **Enable mask zone 1** to set this area as mask.
4. You will see the selected area turn black or white, depending on which color was chosen (This example uses black as the mask color).

Privacy Mask

Settings

Privacy mask color : Black ▾

Mask Zones

- | | | |
|---|---------------------------|---------------------|
| <input checked="" type="checkbox"/> Enable mask zone 1 | Setting Area | Remove |
| <input type="checkbox"/> Enable mask zone 2 | Setting Area | Remove |
| <input type="checkbox"/> Enable mask zone 3 | Setting Area | Remove |

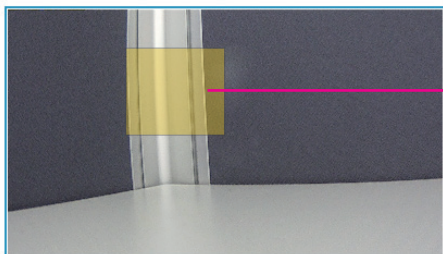

Rectangular square

Mask Zones

- | | | |
|---|---------------------------|---------------------|
| <input checked="" type="checkbox"/> Enable mask zone 1 | Setting Area | Remove |
| <input type="checkbox"/> Enable mask zone 2 | Setting Area | Remove |
| <input type="checkbox"/> Enable mask zone 3 | Setting Area | Remove |

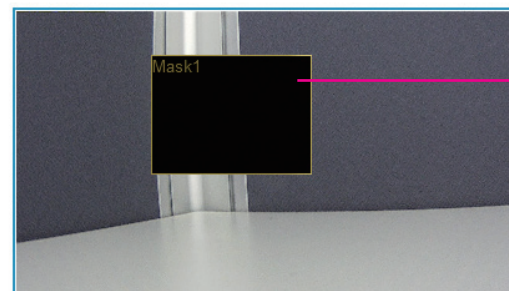

Mask area

5. To create the second and third mask, check the **Enable mask zone 2** and **Enable mask zone 3** options, then repeat steps 2 to 3 outlined earlier.

To delete a mask, check the zone number you like to remove, and press the **Remove** button.

Network

TCP/IP

This section configures the network settings of the camera.

TCP/IP

IP Address Configuration

Enable DHCP

Static IP address

IP Address :

Subnet Mask :

Default Gateway :

Primary DNS Server :

Secondary DNS Server :

Enable IPv6

IP Address :

Current Network Settings

IP Address : 192.168.1.168

Subnet Mask : 255.255.255.0

Default Gateway : 192.168.1.254

Primary DNS Server : 192.168.1.1

Secondary DNS Server : 192.168.1.2

Save

Reset

IP Address Configuration

Enable DHCP

Enables DHCP, use this feature if the camera is connected to a network with DHCP server.

Static IP Address

To manually configure an IP address, select this option and input the IP address, subnet mask, default gateway, primary and secondary DNS server address.

Enable IPv6

To manually configure an IPv6 address, select this option and input the IPv6 address.

Current Network Settings

Displays the current IP address, subnet mask, default gateway, primary and secondary DNS server address of the camera.

Save

Save button to apply the configurations, click on this button once all the settings are confirmed for the new changes to take effect.

Reset

Reset button to discard all the settings applied.

FTP

This section configures the FTP server address that the camera will connect to.

FTP

FTP Server

Host name or IP address :

Upload path :

Port Number :

Login Information

User Name :

Password :

Test Remote FTP server

Server status :

FTP Server

Host Name or IP Address

Specify the host name or IP address of the FTP server.

Upload Path

Specify the directory that the camera will upload data to.

Port Number

Specify the port number of the FTP server.

Login Information

Username

Specify the login username for the FTP server.

Password

Specify the login password for the FTP server.

Test Remote FTP Server

Server Status:

Displays the status of the test connection.

FTP Test

Tests the network connection between the camera and FTP server.

Save

Save button to apply the configurations, click on this button once all the settings are confirmed for the new changes to take effect.

Reset

Reset button to discard all the settings applied.

SMTP

This section configures the SMTP mail server address that the camera will use for sending emails.

SMTP

SMTP Server

Mail server : (Host name or IP address)

Port Number :

Login Information

User Name :

Password :

Email address from :

To Mail Address

Mail address :

Mail Test Status :

SMTP Server

Mail Server

Specify the host name or IP address of the SMTP mail server.

Port Number

Specify the port number of the SMTP mail server.

Login Information

Username

Specify the login username for the SMTP mail server.

Password

Specify the login password for the SMTP mail server.

Email Address From

Specify the email address of the sender.

To Mail Address

Mail Address

Specify the email address to send the email when an event is triggered by motion detection.

Mail Test Status

Displays the status of the test connection.

Mail Test

Tests the network connection between the camera and mail address.

Save

Save button to apply the configurations, click on this button once all the settings are confirmed for the new changes to take effect.

Reset

Reset button to discard all the settings applied.

Ports

This section configures the HTTP port number of the web configuration menu and RTSP port number of stream 1 to 3.

Ports

HTTP

HTTP port: (Range = 80 / 1025~65535)

RTSP

Stream 1 RTSP port:
 Path:
 Stream 2 RTSP port:
 Path:
 Stream 3 RTSP port:
 Path:
 (Range = 554 / 1025~65535)

HTTP

HTTP Port

Configures the HTTP port number of the web configuration menu.

RTSP

Stream 1 to 3 RTSP Port

Configures the RTSP port number of stream 1 to 3, and displays the URL of stream 1 to 3. The range is 554/1025~65535.

Default URL of Stream 1: rtsp://cameraIP:554/live/stream1

Default URL of Stream 2: rtsp://cameraIP:8556/live/stream2

Default URL of Stream 3: rtsp://cameraIP:8555/live/stream3

Save

Save button to apply the configurations, click on this button once all the settings are confirmed for the new changes to take effect.

Reset

Reset button to discard all the settings applied.

Events

Motion Detection

This section configures which area of the live video in **Viewer** will be monitored for detecting motion.

Motion Detection

Settings

Enable motion detection

Sensitivity : (Range : 1~100)

Detection Zones

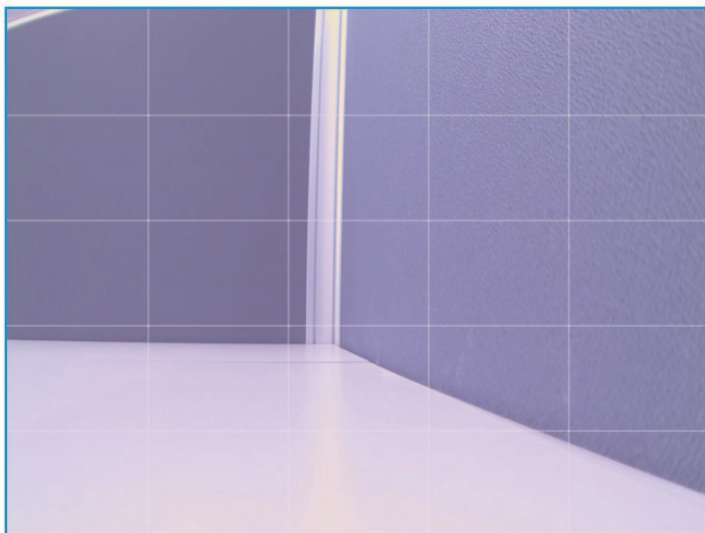

Save

Reset

Settings

Enable Motion Detection

Enables or disables motion detection function.

Sensitivity

Configures the sensitivity of motion detection, the sensitivity determines the amount of motion required to trigger an event, the range is 1 to 100, with 1 being the least sensitive. For more information on event, please refer to **Event Actions** on page 32.

Detection Zones

This section shows the live video from the camera, the screen is divided into 5x5 rectangular boxes, to setup motion detection, please follow the instructions below.

1. Check the **Enable motion detection** option, and specify the sensitivity level.
2. In the live video screen below, select the desired area for motion detection by clicking on the rectangular box. The border of the box will turn red indicating that it is selected. You can select multiple boxes, up to 5x5 boxes can be selected.
3. Press the **Save** button once all the desired areas are selected for the changes to take effect.

Motion Detection

Settings

Enable motion detection
Sensitivity : (Range : 1~100)

Detection Zones



Highlighted
box

Motion Detection

Settings

Enable motion detection
Sensitivity : (Range : 1~100)

Detection Zones

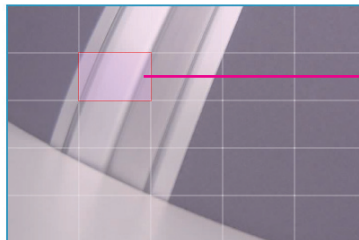

Area with
motion detect
enabled

To remove motion detection from an area, click the box to deselect it, then press the **Save** button for the changes to take effect.

Alarm In/Out Trigger

This section configures the IP camera to work with external alarm in/out devices.

Alarm In Out Actions

Alarm In Control

Alarm In mode

Alarm In Level

Alarm Out Control

Alarm Out mode

Alarm Out level

Alarm In Control

Alarm In Mode

Enables or disables monitoring of alarm input. Enable this option if an external sensor device connected to the alarm input requires monitoring.

Alarm In Level

Specify the signal level required for triggering the alarm device connected to the alarm output. The options are **Low** and **High**.

Alarm Out Control

Alarm Out Mode

Specify the alarm out mode, the options are **User Mode** and **Event Mode**. When **User Mode** is selected, the alarm output will be triggered based on user configurations. When **Event Mode** is selected, the alarm output will be triggered based on the configurations set in **Event Actions**. For more information on **Event Actions**, please refer to page 32.

Alarm Out Level

Specify the alarm output action to perform when it is triggered. The options are **Low** and **High**.

Save

Save button to apply the configurations, click on this button once all the settings are confirmed for the new changes to take effect.

Reset

Reset button to discard all the settings applied.

Event Actions

This section configures what actions to perform when an event is triggered from motion detection.

Event Actions

When Motion Detection Triggered...

- Save stream to SD card
File format:
- Upload stream to FTP server
File format:
- Send email notification
- Alarm Output

When Alarm In Triggered...

- Save stream to SD card
File format:
- Upload stream to FTP server
File format:
- Send email notification
- Alarm Output



When Motion Detection Triggered

Save Stream to SD Card

Check this option to store the video stream onto the SD card. Select the desired file format in the drop down menu, the options are **AVI** and **JPEG**.

Upload Stream to FTP Server

Check this option to upload the video stream to a FTP server. Select the desired file format in the drop down menu, the options are **AVI** and **JPEG**. For information on configuring the FTP server, please refer to **FTP** on page 26.

Send Email Notification

Check this option to send an email notifying the event, for more information on configuring the email address, please refer to **SMTP** on page 27.

Alarm Output

Check this option to activate the device connected to alarm output when motion detection is triggered.

When Alarm In Triggered

Save Stream to SD Card

Check this option to store the video stream onto the SD card. Select the desired file format in the drop down menu, the options are **AVI** and **JPEG**.

Upload Stream to FTP Server

Check this option to upload the video stream to a FTP server. Select the desired file format in the drop down menu, the options are **AVI** and **JPEG**. For information on configuring the FTP server, please refer to **FTP** on page 26.

Send Email Notification

Check this option to send an email notifying about the alarm event, for more information on configuring the email address, please refer to **SMTP** on page 27.

Alarm Output

Check this option to activate the device connected to alarm output when alarm in is triggered.

Save

Save button to apply the configurations, click on this button once all the settings are confirmed for the new changes to take effect.

Reset

Reset button to discard all the settings applied.

System

Audio

This section is used to configure the audio settings.

Audio

Audio Settings

Audio In Enable

Audio In Volume : (Range = 1~100)

Audio Out Enable

Audio Out Volume : (Range = 1~100)

Save

Reset

Audio Settings

Audio In Enable

Enables or disables audio-in on the camera. When enabled, specify the volume in the **Audio In Volume** textbox. The range is 1~100.

Audio Out Enable

Enables or disables audio-out on the camera. When enabled, specify the volume in the **Audio Out Volume** textbox. The range is 1~100.

Save

Save button to apply the configurations, click on this button once all the settings are confirmed for the new changes to take effect.

Reset

Reset button to discard all the settings applied.

Recording Settings

This section is used to configure the recording settings of the IP camera.

Recording Settings

AVI File Setting

Stream Source:

Save

Reset

AVI File Setting

Stream Source

Selects which video stream number to record, the options are **Stream 1** and **Stream 2**.

Save

Save button to apply the configurations, click on this button once all the settings are confirmed for the new changes to take effect.

Reset

Reset button to discard all the settings applied.

User Management

This section is used to manage user accounts for accessing the IP camera's web configuration menu.

User Management

Add / Modify User Accounts

User Name	Password	Confirm Password	Authority	User Information
<input type="text"/>	<input type="text"/>	<input type="text"/>	Operator ▼	<input type="text"/>

(Username and password must be for least 1 characters.)

User List

User Name	User Group	User Information	Edit User	Delete User
admin	Administrator	Administrator	<input type="button" value="Edit"/>	

Add/Modify User Accounts

To add a user account, type in the username and password (username and password must be at least 1 character), retype the password to confirm, then choose the access level for the account in the **Authority** drop down list. You can also provide a description for the account under the **User Information** field.

Access Level

Administrator: Has full control (read/write) over every configuration menu item.

Operator: Has full control (read/write) over every configuration menu item in **Video** and **Event** only.

Viewer: Only has access (read) to the live view of the camera (main screen).

User List

Displays user accounts available on the camera, to edit an account's password, click the **Edit** button, then retype the new password in the **Password** and **Confirm Password** fields.

Save

Save button to apply the configurations, click on this button once all the settings are confirmed for the new changes to take effect.

Reset

Reset button to discard all the settings applied.

SD Card Management

This section is used to manage the SD card.

SD Card Management

SD Card Information

Format

SD card is unavailable

SD card available : NO SD

SD card use% : NO SD

SD Card Overwrite : OFF ON

Save

File List

Folder Name

Filename	Date	Time	Size	Action
----------	------	------	------	--------

SD Card Information

If a SD card is installed, this section will display information on the availability of the SD card, and the percentage of the total storage used.

Format

Formats the SD card, all data stored on the SD card will be erased if this option is used.

SD Card Overwrite

Enables or disables overwrite protection for the SD card. Press the **Save** button to apply the setting.

File List

Displays the information of the folders and files stored in the SD card.

Date & Time

This section configures the date and time on the camera.

Date & Time

Current Camera Time

Date : 2013/04/23 Tue

Time : 09:42:03

Time Settings

Time mode :

- Synchronize with NTP server
 Synchronize with computer time
 Manually setting

Date : 2013 / 4 / 23 Time : 9 : 42 : 0 AM

Time zone :

(GMT+08) Taipei, Beijing, Chongqing, Urumqi, Hong Kong, Perth, Singapore

Daylight saving

Date : 2013 / 3 / 10 Time : 2 : 0 AM [Start]

Date : 2013 / 11 / 3 Time : 2 : 0 AM [End]

Date & Time Format

Date format : YYYY/MM/DD

Time format : 24Hrs

NTP Server

NTP server address : (Host name or IP address)

Save

Reset

Current Camera Time

Displays the current date and time on the camera.

Time Settings

Synchronize with NTP Server

Select this option to synchronize the date and time with a NTP server.

Synchronize with Computer Time

Select this option to synchronize the date and time to the computer connected to the camera.

Manually Setting

Select this option to manually configure the date and time.

Time Zone

Select the time zone relevant to your location in the drop down list.

Daylight Saving

Select this option to enable daylight saving. The Start/End date and time for daylight saving can be manually configured in the text boxes beneath the option.

Date & Time Format

Date Format

Configures the format that the date will be displayed in. The options are **YYYY/MM/DD**, **MM/DD/YYYY** and **DD/MM/YYYY**.

Time Format

Configures the format that the time will be displayed in. The options are **12Hrs** and **24Hrs**.

NTP Server

NTP Server Address

If **Synchronize with NTP Server** is selected as the time mode, type in the host name or IP address of the NTP server.

Save

Save button to apply the configurations, click on this button once all the settings are confirmed for the new changes to take effect.

Reset

Reset button to discard all the settings applied.

Firmware Upgrade

This section is used to update the IP camera's firmware.

Firmware Upgrade

Firmware Version

Application version : NexWare_02.00.0005

Firmware Update

Specify the firmware image file to upgrade :

Firmware Version

Application Version

Displays the current firmware version.

Update

Specify the Firmware Image File to Upgrade

To update the camera's firmware, click on the **Browse** button and locate the firmware image file, once the file is selected, press the **Update** button to begin.



The firmware update process will take around 15 minutes to complete, during this time, do not disconnect the network cable, reset or power off the IP camera, as you may damage the device.

Maintenance

This section is used to restart the IP camera, or restore it to factory default settings.

Maintenance

Maintain

Restart

Reboot the camera.

Reset to Default

Resets all camera parameters to the factory default settings.

Camera Name Settings

Camera Name :

Save

Reset

Maintain

Restart

Click this button to reboot the camera.

Reset to Default

Click this button to restore all the camera's setting back to factory default.

Camera Name Settings

Camera Name

Specify a name for the camera. The name will be displayed in the upper left corner on the live video stream of the camera. To enable this, make sure the option **Display Camera Name** in the **Overlay Settings** menu is checked. For information on the **Overlay Settings** menu, please refer to page 22.

Save

Save button to apply the configurations, click on this button once all the settings are confirmed for the new changes to take effect.

Reset

Reset button to discard all the settings applied.

Advanced Settings

This section is used to configure advanced settings of the IP camera.

3MP Outdoor IR Bullet Camera Live View Setup

Advanced Settings

- Video
 - Camera Settings
 - ROI
 - AE Weights
- Network
 - DDNS
 - SNMP
 - Multicast
- Events
 - Ethernet Lost Detection
 - Face Detection
 - Tampering Detection
 - Event Actions
- System
 - Schedule Recording
- Basic Settings

Advanced Camera Settings Quick viewer

Chroma & Sharpness Suppression

- Enable chroma suppression
- Enable sharpness suppression

Manual White Balance

R/G gain: (Range = 0.0-4.0)
 B/G gain: (Range = 0.0-4.0)

Note : Manual White Balance will be enabled while "White balance mode" on basic settings is "off"

Manual Exposure & Gain

Manual gain: (Range = 1-512)
 Manual exposure time : 1 / s (Range = 7-20000)

Note : Manual exposure will be enabled while "Exposure mode" on basic settings is "Locked"

Auto Exposure Configuration

Maximum exposure time : 1 / s (Range = 7-1000)
 Maximum sens up gain : (Range = 1-512)

Note : "Exposure mode" on basic settings must be "non-Locked", "slow shutter" or "sens up" is "User define"

P-Iris Control

- Auto
- Manual

Iris value adjust: (Range = 0-100)

Note : 0 = Min. Iris, 100 = Max. Iris

IR Cut Filter (ICR) Control

- Auto
- Day mode
- Night mode

The following are the advanced settings available on the left hand side:

- Video
 - Camera Settings
 - ROI
 - AE Weights
- Network
 - DDNS
 - SNMP
 - Multicast
- Events
 - Ethernet Lost Detection
 - Face Detection
 - Tampering Detection
 - Event Actions
- System
 - Schedule Recording
- Basic Settings

Video

Camera Settings (Advanced)

This section is used to adjust the camera's advanced image settings.

Advanced Camera Settings

[Quick viewer](#)

Chroma & Sharpness Suppression

- Enable chroma suppression
- Enable sharpness suppression

Manual White Balance

R/G gain : (Range = 0.0~4.0)

B/G gain : (Range = 0.0~4.0)

Note : Manual White Balance will be enabled while "White balance mode" on basic settings is "off"

Manual Exposure & Gain

Manual gain : (Range = 1~512)

Manual exposure time : 1 / s (Range = 7~20000)

Note : Manual exposure will be enabled while "Exposure mode" on basic settings is "Locked"

Auto Exposure Configuration

Maximum exposure time : 1 / s (Range = 7~1000)

Maximum sens up gain : (Range = 1~512)

Note : "Exposure mode" on basic settings must be "non-Locked", "slow shutter" or "sens up" is "User define"

P-Iris Control

- Auto
- Manual

Iris value adjust : (Range = 0~100)

Note : 0 = Min. Iris, 100 = Max. Iris

Chroma & Sharpness Suppression

Enable Chroma Suppression

Enables or disables chroma suppression. Enabling chroma suppression will reduce the image noise captured from low-light environments.

Enable Sharpness Suppression

Enables or disables sharpness suppression. Enabling sharpness suppression will minimize the sharpness caused by noise in low-light captures.

Manual White Balance

Note: To adjust the white balance manually, please set the **White Balance Mode** to **Off** in **Basic Settings**.

R/G Gain

Adjusts the warm white balance, the range is 0.0 ~ 4.0 (from yellow to red).

B/G Gain

Adjusts the cold white balance, the range is 0.0 ~ 4.0 (from green to blue).

Manual Exposure & Gain

Note: To adjust the exposure and gain manually, please set the **Exposure Mode** to **Locked** in **Basic Settings**.

Manual Gain

Adjusts the camera's gain manually, the range is 1 ~ 512. Setting a higher value will increase the camera's signal and produce brighter images for low-light environments.

Manual Exposure Time 1:1 and 2:1

Adjusts the camera's exposure manually, the range is 1:1/7 ~ 1:1/20000 and 2:1/7 ~ 2:1/20000, with 1/20000 being the shortest exposure length.

Camera Settings (Advanced) Cont.

P-Iris Control

 Auto

 Manual

 Iris value adjust: (Range = 0~100)

Note : 0 = Min. Iris, 100 = Max. Iris

IR Cut Filter (ICR) Control

 Auto

 Day mode

 Night mode

 Schedule ICR :

 Start time : : End time : : Use mode :

 Please set the non-specified time range, use mode :

IR LED Control

 Auto control by light sensor

 Turn-on

 Turn-off

 Schedule IR :

 Start time : : End time : : Use mode :

 Please set the non-specified time range, use mode :

Gamma Control

 Default

 Gamma value : (Range = 0.01~1.00)

Auto Exposure Configuration

Maximum Exposure Time

Specifies the maximum exposure time when operating in Auto Exposure mode, the range is 1/7 ~ 1/1000, with 1/1000 being the shortest exposure length.

Maximum Sens Up Gain

Specifies the maximum gain when operating in Auto Exposure mode, the range is 1 ~ 512, with 1 being the lowest gain.

P-Iris Control

Auto

When enabled, the P-Iris will adjust the opening automatically based on the lighting levels in the environment.

Manual

Adjust the opening of the iris manually in the range of 0 ~ 100, with 0 being the smallest value.

IR Cut Filter (ICR) Control

Auto

When enabled, the camera will automatically turn the infrared lights on or off based on the lighting levels in the environment.

Day Mode

Enables day mode and turns the IR cut filter control off.

Night Mode

Enables night mode and turns the IR cut filter control on.

Schedule ICR

Enables or disables IR cut filter control function to activate at the specified time. You can configure the **Start Time** and **End Time** in 24-hour format.

Use Mode (During Scheduled Hours)

Selects the IR cut filter control mode to use during the scheduled time.

Use Mode (Outside of the Scheduled Hours)

Selects the IR cut filter control mode to use outside of the scheduled time.

IR LED Control

Auto Control by Light Sensor

When enabled, the camera will automatically turn the infrared LEDs on or off based on the amount of light received by the image sensor.

Turn-on

Turns the IR LED on.

Turn-off

Turns the IR LED off.

Schedule IR

Enables or disables IR LED control function to activate at the specified time. You can configure the **Start Time** and **End Time** in 24-hour format.

Use Mode (During Scheduled Hours)

Selects the IR LED control mode to use during the scheduled time.

Use Mode (Outside of the Scheduled Hours)

Selects the IR LED control mode to use outside of the scheduled time.

Gamma Control

Default

Activates the default gamma state.

Gamma

Adjusts the gamma manually, the range is 0.01 ~ 1.00, with 0.01 being the lowest value.

Save

Save button to apply the configurations, click on this button once all the settings are confirmed for the new changes to take effect.

Reset

Reset button to discard all the settings applied.

ROI

You can configure up to 5 ROI zones. ROI is used to select which areas will be monitored and recorded with higher image quality while using lower image quality for other non-ROI zones to save bandwidth and storage. The instructions below illustrate how to setup 5 ROI zones.

1. To create ROI zone 1, check the **Enable ROI zone 1**, and on the live video screen, select the area to set the ROI by holding down the mouse button and drag to make a rectangular square, release the button once the desired area is covered.
2. Press the **Setting Area** button in **Enable ROI zone 1** to set this area as the ROI.
3. Repeat the above steps to create ROI for zones 2 to 5.

To delete an area, check the ROI zone number you like to remove, and press the **Remove** button.

ROI

Region of interest configuration

<input checked="" type="checkbox"/> Enable ROI zone 1	Setting Area	Remove
<input checked="" type="checkbox"/> Enable ROI zone 2	Setting Area	Remove
<input type="checkbox"/> Enable ROI zone 3	Setting Area	Remove
<input type="checkbox"/> Enable ROI zone 4	Setting Area	Remove
<input type="checkbox"/> Enable ROI zone 5	Setting Area	Remove

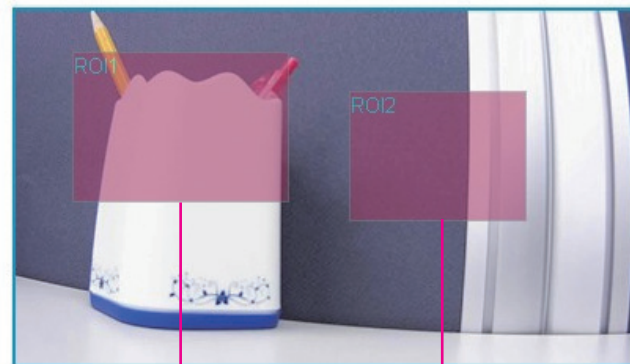

ROI zone 1

ROI zone 2

Auto Exposure Weights

You can select up to 5 areas and configure the exposure weighting for each area manually. The weighting determines the importance of the area captured, a higher weighting value will increase the sensitivity of the auto exposure.

1. To create an auto exposure area, select **User Define** and check the **Enable Regional weighting 1**.
2. On the live video screen, select the area by holding down the mouse button and drag to make a rectangular square, release the button once the desired area is covered.
3. Press the **Setting Area** button in **Enable Regional weighting 1**.
4. Configure the weighting value in the corresponding textbox, the range is 0 ~ 10.
5. Repeat the above steps to create auto exposure weightings for zones 3 to 5.

To delete an area, check the zone number you like to remove, and press the **Remove** button.

To allow the camera to adjust the exposure automatically, select the **Auto** option.

Background Others

Configures the weighting value of the area outside of the selected zones.

Auto Exposure Weights

Settings

Auto
 User define

<input checked="" type="checkbox"/> Enable Regional weighting 1	<input type="button" value="Setting Area"/>	<input type="button" value="Remove"/>	<input type="text" value="1"/>	(Range = 0~10)
<input checked="" type="checkbox"/> Enable Regional weighting 2	<input type="button" value="Setting Area"/>	<input type="button" value="Remove"/>	<input type="text" value="5"/>	(Range = 0~10)
<input type="checkbox"/> Enable Regional weighting 3	<input type="button" value="Setting Area"/>	<input type="button" value="Remove"/>	<input type="text" value="1"/>	(Range = 0~10)
<input type="checkbox"/> Enable Regional weighting 4	<input type="button" value="Setting Area"/>	<input type="button" value="Remove"/>	<input type="text" value="1"/>	(Range = 0~10)
<input type="checkbox"/> Enable Regional weighting 5	<input type="button" value="Setting Area"/>	<input type="button" value="Remove"/>	<input type="text" value="1"/>	(Range = 0~10)
			Background others :	<input type="text" value="1"/> (Range = 0~10)

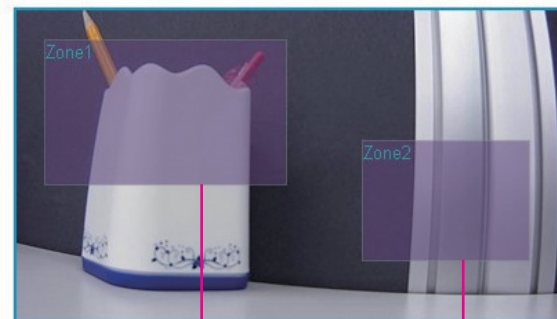

Zone 1

Zone 2

Network

DDNS

This section is used to configure DDNS (Dynamic DNS).

Note: Different DDNS service provider may have different input fields.

DDNS

DDNS Settings

DDNS Service: Dyn [WebSite](#)

Username :

Password :

Hostname :

Internet IP Address : Manual

Status :

DDNS Settings

DDNS Service

Select the DDNS service provider from the drop down list, the available providers are **Dyn**, **NO-IP**, **dnsExit** and **DtDNS**.

Web Site

URL link to the selected DDNS service provider's web site.

Username

Username of the DDNS account.

Password

Password of the DDNS account.

Hostname

Hostname of the DDNS account.

Internet IP Address

Displays the IP address assigned when the connection is established.

Manual

Used to manually specify an IP address of a DDNS server.

Status

Displays the connection status of the DDNS service.

SNMP

Simple Network Management Protocol (SNMP) is a protocol that can be used to manage and monitor SNMP-enabled devices over a network. The SNMPv1, SNMPv2 and SNMPv3 settings for the IP camera can be configured in this page.

SNMP

SNMP v1 / v2

Enable SNMP v1 / v2

Read community :

Write community :

Traps for SNMP v1 / v2

Enable traps

Trap address :

Trap community :

SNMP v3

Enable SNMP v3

user name :

user password :

SNMP v1/v2

Enable SNMP v1/v2

Enables or disables SNMPv1 and SNMPv2 support.

Read Community

Used to configure the read community string.

Write Community

Used to configure the write community string.

Traps for SNMP v1/v2

Enable Traps

Enables the IP camera to send SNMP trap messages.

Trap Address

Specifies the IP address of the trap server to receive the trap messages.

Trap Community

Used to configure the trap community string.

SNMP v3

Enable SNMP v3

Enables or disables SNMPv3 support.

User name

Used to configure the SNMPv3 username.

User password

Used to configure the SNMPv3 password.

Multicast

The IP camera's video streams can be sent to a multicast IP address group for one-to-many streaming. The multicast settings for the IP camera can be configured in this page.

Multicast

Settings

Enable multicast

Group address:

Stream 1 RTP Port:

RTCP Port:

Path:

Always multicast

Stream 2 RTP Port:

RTCP Port:

Path:

Always multicast

Stream 3 RTP Port:

RTCP Port:

Path:

Always multicast

Audio RTP Port:

RTCP Port:

(RTP and RTCP Port Range = 1025~65535)

TTL: (Range = 1~255)

Settings

Enable Multicast

Enables or disables multicast streaming.

Group Address

Configures the IP address of the multicast group.

RTP Port

Configures the RTP port of the multicast address, this port is used for streaming video and audio data.

RTCP Port

Configures the RTCP port of the multicast address, this port is used for controlling RTP streams.

Path

Configures the URL address of the video stream.

Always Multicast

Check this option to enable the video stream to start multicast streaming without using RTCP.

Audio RTP Port and RTCP Port

Configures the port numbers for RTP audio and RTCP, the range is 1025 ~ 65535.

TTL

Configures the time-to-live threshold of the multicast datagram before it is discarded by the router.

Events

Ethernet Lost Detection

This page is used to configure link failure detection for Ethernet.

Ethernet Lost Detection

Settings

- Enable ethernet lost detection
- Alarm Output

Settings

Enable Ethernet Lost Detection

Enables link failure detection of the Ethernet connection.

Alarm Output

Enables the camera to trigger the device connected to alarm output upon detecting failure of the Ethernet connection.

Face Detection

You can configure the camera to detect faces and trigger the events enabled in the **Event Actions** menu on page 54. The instructions below illustrate how to setup face detection.

1. Check the **Enable Face Detection** and on the live video screen below, select the area for face recognition by holding down the mouse button and drag to make a rectangular square, release the button once the desired area is covered.
2. Press the **Setting Area** button to set this area for face recognition.

To delete the area, press the **Remove** button.

Threshold

Configures the sensitivity of the face recognition, the range is 1~9, with 1 being the least sensitive.

Detect Direction

Configures the direction to detect faces.

- Up: Detect faces on the top (90 degrees from the front).
 Right: Detect faces on the right (180 degrees from the front).
 Left: Detect faces on the left (-180 degrees from the front).
 Down: Detect faces on the bottom (-90 degrees from the front).

Detection Box

Configures which detection zones are used for face recognition, the options are **Rectangle**, **ROI** and **Rectangle + ROI**.

Face Detection

Detection Zones

Enable Face Detection

Threshold: (Range = 1~9)

Detect direction:

Detection box:

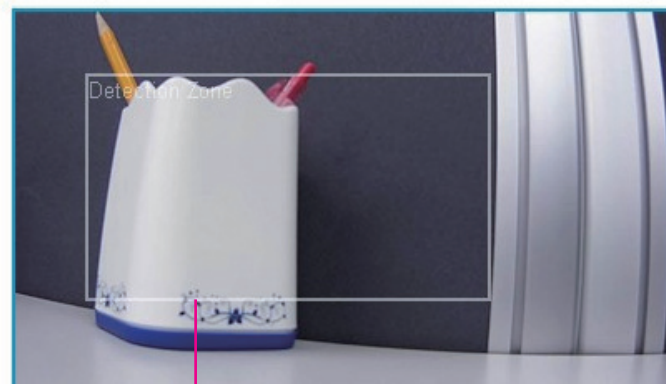

Detection Zone

Tampering Detection

This section is used to configure tamper detection settings.

Tampering Detection

Settings

Enable tampering detect

Sensitivity : (Range = 1~100)

Settings

Enable Tampering Detect

Enables or disables tamper detection. When enabled, the camera will trigger actions enabled in the **Event Actions** menu upon detecting image blurs.

Sensitivity

Configures the sensitivity of the tamper detection, the range is 1~100, with 1 being the least sensitive.

Event Actions (Advanced)

This section configures what actions to perform when an event is triggered from face detection and tampering detection.

Advanced Event Actions

When Face Detection Triggered...

- Save stream to SD card
File format:
- Upload stream to FTP server
File format:
- Send email notification
- Alarm Output

When Tampering Detection Triggered...

- Save stream to SD card
File format:
- Upload stream to FTP server
File format:
- Send email notification
- Alarm Output

When Motion Detection Triggered

Save Stream to SD Card

Check this option to store the video stream onto the SD card. Select the desired file format in the drop down menu, the options are AVI and JPEG.

Upload Stream to FTP Server

Check this option to upload the video stream to a FTP server. Select the desired file format in the drop down menu, the options are AVI and JPEG. For information on configuring the FTP server, please refer to FTP on page 26.

Send Email Notification

Check this option to send an email notifying the event, for more information on configuring the email address, please refer to SMTP on page 27.

Alarm Output

Check this option to activate the device connected to alarm output when face detection is triggered.

When Tampering Detection Triggered

Save Stream to SD Card

Check this option to store the video stream onto the SD card. Select the desired file format in the drop down menu, the options are AVI and JPEG.

Upload Stream to FTP Server

Check this option to upload the video stream to a FTP server. Select the desired file format in the drop down menu, the options are AVI and JPEG. For information on configuring the FTP server, please refer to FTP on page 26.

Send Email Notification

Check this option to send an email notifying about the alarm event, for more information on configuring the email address, please refer to SMTP on page 27.

Alarm Output

Check this option to activate the device connected to alarm output when tampering detection is triggered.

System

Schedule Recording

This section is used to schedule the recording of the video streams.

Schedule Recording

Schedule Recording Setting

Enable Schedule Recording

Daily :
 Start time : : End time : :

Weekly :

	0	1	2	3	4	5	6	7	8	9	10	11	12	13	14	15	16	17	18	19	20	21	22	23	S	D
Sun																										
Mon														E												
Tue																										
Wed																										
Thu																										
Fri																										
Sat																										

Schedule Recording Setting

Enable Schedule Recording

Enables or disables recording of the video stream.

Daily

Configures the camera to record at the specified **Start Time** and **End Time**.

Weekly

Configures the camera to record on the specified day and time of the week.

S

Select this to set full-day recording.

D

Select this to cancel full-day recording.

E

Displays the end time of the recording, clicking **E** will allow you to configure the start time and end time.

CHAPTER 3: VIEWING LIVE VIDEO VIA VLC MEDIA PLAYER

The IP camera's live video can be viewed by third party media players such as VLC media player by VideoLAN project. To stream the live video from the camera to VLC media player through the network, please follow the instructions below.

1. Locate and open VLC media player.
2. Go to **Media** -> **Open Network Stream**.
3. Enter the following RTSP URL:

```
rtsp://192.168.1.168:554/live/stream1
```

Note: RTSP URL of stream 1, similarly you can view stream 2 and 3 of the camera by entering their corresponding URLs. Please refer to **Ports** on page 28 for more information on the URL link.

4. Press the **Play** button to start streaming.

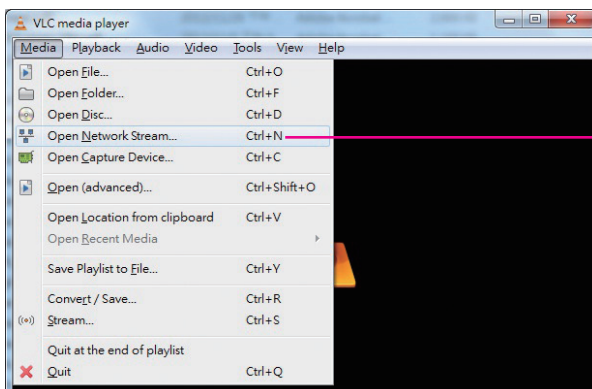

Open Network Stream

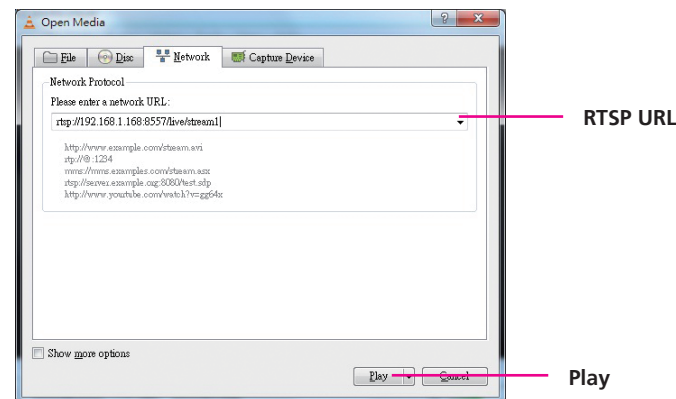

5. You will be prompted with a pop-up window asking for login information, type in "admin" (default login name) and "9999" (default password)

