

NexAIoT Co., Ltd.

IoT Automation Solutions Business Group

Applied Panel PC

APPC 1260T-A01/APPC 1560-A01/APPC 1660-A01/

APPC 1760-A01/APPC 1960-A01/APPC 2160-A01

User Manual

CONTENTS

Preface

Copyright	iv
Disclaimer	iv
Acknowledgements	iv
Regulatory Compliance Statements	iv
Declaration of Conformity	iv
RoHS Compliance	v
Warranty and RMA	vi
Safety Information	ix
Installation Recommendations	ix
Safety Precautions	x
Technical Support and Assistance	xi
Conventions Used in this Manual	xi
Global Service Contact Information	xii
Package Contents	xiv
Ordering Information	xv

Chapter 1: Product Introduction

APPC 1260T-A01	1
APPC 1560-A01	2
APPC 1660-A01	3
APPC 1760-A01	4
APPC 1960-A01	5
APPC 2160-A01	6

Specifications	7
APPC 1260T-A01	7
APPC 1560-A01/APPC 1660-A01/APPC 1760-A01/ APPC 1960-A01/APPC 2160-A01	9
Knowing Your APPC Series	15
Rear Bottom	15
Rear Panel	17
Mechanical Dimensions	18
APPC 1260T-A01	18
APPC 1560-A01	19
APPC 1660-A01	20
APPC 1760-A01	21
APPC 1960-A01	22
APPC 2160-A01	23

Chapter 2: Jumpers and Connectors

Before You Begin	24
Precautions	24
Jumper Settings	25
Locations of the Jumpers and Connectors	26
Jumpers	27
Resistance Touch 4/5 Wire Select	27
Panel VCC Power Select	27
LVDS EDP Signal Select	28
LCD Panel VDD Power Select	28

Panel Backlight Control Select (CCFL/ PWM Mode)	29
Clear CMOS	29
AT/ATX Selection DIP Switch	30
External I/O Interfaces	31
USB 3.2 Type-C	31
USB 3.2 Type-A	31
24V DC Power Input	32
COM 1 Port	32
COM 2 Port	33
Reset Pin Header	33
Remote Power	34
DisplayPort 1.4a	34
LAN Ports	35
Power Button	36
Internal Connectors	37
USB 2.0	37
M.2 Key B	38
Mini PCIe	40
M.2 Key B	41
COM Ports	43
Debug Port	44
DIO Pin Header	44
Panel LED	45
Panel Backlight	45
Resistance Touch	46
eDP Panel Backlight Control (Reserved)	46
Speaker	47
Line In	47
Line Out	48
LVDS	49

Mic In	50
nano-SIM	50

Chapter 3: System Setup

Removing the Rear Cover	51
Replacing an SO-DIMM memory module	52
Installing a Wireless LAN Module in a Mini PCIe Slot	54
Installing a Wireless LAN Module in an M.2 Key B Slot	56
Installing a SIM Card	59
Installing an Antenna	62
Panel Mounting	64

Chapter 4: BIOS Setup

About BIOS Setup	70
When to Configure the BIOS	70
Default Configuration	71
Entering Setup	71
Legends	71
BIOS Setup Utility	73
Main	73
Advanced	74
Chipset	82
Security	86
Boot	87
Save & Exit	88

Appendix A: Power Consumption

Test Equipment/Software	89
Power consumption	89

PREFACE

Copyright

This publication, including all photographs, illustrations and software, is protected under international copyright laws, with all rights reserved. No part of this manual may be reproduced, copied, translated or transmitted in any form or by any means without the prior written consent from NexAloT Co., Ltd.

Disclaimer

The information in this document is subject to change without prior notice and does not represent commitment from NexAloT Co., Ltd. However, users may update their knowledge of any product in use by constantly checking its manual posted on our website: <http://www.nexaiot.com>. NexAloT shall not be liable for direct, indirect, special, incidental, or consequential damages arising out of the use of any product, nor for any infringements upon the rights of third parties, which may result from such use. Any implied warranties of merchantability or fitness for any particular purpose is also disclaimed.

Acknowledgements

APPC 1260T-A01, APPC 1560-A01, APPC 1660-A01, APPC 1760-A01, APPC 1960-A01, and APPC 2160-A01 are trademarks of NexAloT Co., Ltd. All other product names mentioned herein are registered trademarks of their respective owners.

Regulatory Compliance Statements

This section provides the FCC compliance statement for Class A devices and describes how to keep the system CE compliant.

Declaration of Conformity

FCC

This equipment has been tested and verified to comply with the limits for a Class A digital device, pursuant to Part 15 of FCC Rules. These limits are designed to provide reasonable protection against harmful interference when the equipment is operated in a commercial environment. This equipment generates, uses, and can radiate radio frequency energy and, if not installed and used in accordance with the instructions, may cause harmful interference to radio communications. Operation of this equipment in a residential area (domestic environment) is likely to cause harmful interference, in which case the user will be required to correct the interference (take adequate measures) at their own expense.

CE

The product(s) described in this manual complies with all applicable European Union (CE) directives if it has a CE marking. For computer systems to remain CE compliant, only CE-compliant parts may be used. Maintaining CE compliance also requires proper cable and cabling techniques.

RoHS Compliance



NexAloT RoHS Environmental Policy and Status Update

NexAloT is a global citizen for building the digital infrastructure. We are committed to providing green products and services, which are compliant with European Union RoHS (Restriction on Use of Hazardous Substance in Electronic Equipment) directive 2011/65/EU, to be your trusted green partner and to protect our environment.

RoHS restricts the use of Lead (Pb) < 0.1% or 1,000ppm, Mercury (Hg) < 0.1% or 1,000ppm, Cadmium (Cd) < 0.01% or 100ppm, Hexavalent Chromium (Cr6+) < 0.1% or 1,000ppm, Polybrominated biphenyls (PBB) < 0.1% or 1,000ppm, and Polybrominated diphenyl Ethers (PBDE) < 0.1% or 1,000ppm.

In order to meet the RoHS compliant directives, NexAloT has established an engineering and manufacturing task force to implement the introduction of green products. The task force will ensure that we follow the standard NexAloT development procedure and that all the new RoHS components and new manufacturing processes maintain the highest industry quality levels for which NexAloT are renowned.

The model selection criteria will be based on market demand. Vendors and suppliers will ensure that all designed components will be RoHS compliant.

How to recognize NexAloT RoHS Products?

For existing products where there are non-RoHS and RoHS versions, the suffix "(LF)" will be added to the compliant product name.

All new product models launched after January 2013 will be RoHS compliant. They will use the usual NexAloT naming convention.

Warranty and RMA

NexAloT Warranty Period

1. NexAloT makes products in accordance with the Industry standard and, NexAloT warrants that all her Industry-grade IPC and System products will be free from defect in neither material nor workmanship for twenty-four (24) months from the day of invoice issued.
2. For NexAloT Panel PC product lines (the APPC, MPPC series), they are also guaranteed against defect in materials and workmanship for the period of twenty-four (24) months in their motherboard design. For 3rd party parts, it follows with original suppliers' standard: 12 months for battery pack and LCD, 24 months for adaptor / add on modules (including GSM module, RFID module, and antenna).
3. If NexAloT determines customer's warranty claim is valid, NexAloT will repair or replace product(s) without additional charge for parts and labor. An extended Warranty Program will extend the warranty period of the product accordingly.

Warranty Coverage

The warranty applies only to products manufactured or distributed by NexAloT and its subsidiaries. This warranty covers all the products/shipments except for:

1. Any claimed defect, products that have been repaired or modified by persons who have not been authorized by NexAloT or, products which have been subjected to misuse, abuse, accident, improper installation, or usage not in accordance with the product instruction. NexAloT assumes no liability as a consequence of such events under the term of this warranty.

One example is the replacement of Tablet's or Hand-held's LCD display due to scratching stains or other degradation; these will not be covered under this warranty.

2. Damages caused by customers' delivery/shipping of the product or, product failure resulted from electrical power/voltage shock, or, installation of parts/components which are not supplied/approved by NexAloT in advance.
3. Third-party products:
 - a. Software, such as the device drivers,
 - b. External devices such as HDD, printer, scanner, mouse, LCD panel, battery, and so on,
 - c. Accessory/parts that were not approved by NexAloT and,
 - d. Accessory/parts were added to products after they were shipped from NexAloT.

Product will be treated as "Out of Warranty" if:

- a. It expires the warranted 24 months period from the day it was purchased.
- b. It had been altered by persons other than an authorized NexAloT service person or, which have been subjected to misuse, abuse, accident, or improper installation.
- c. It doesn't have the original NexAloT Serial Number labeling for NexAloT's warranty period identification or, tracking.

RMA that NexAloT has determined not to be covered by the warranty will be charged the NexAloT Standard Repair Fee for the repairing. If a RMA is determined to be not repairable, customer will be notified and product(s) may be returned to customer at their request; a minimum service fee may be charged however.

NexAloT Return Merchandise Authorization (RMA) Procedure

For the RMA (Return Merchandise Authorization) shipment, customer is responsible for packaging and shipping the product to the designated NexAloT service sites, with shipping charges prepaid by the customer. The original NexAloT shipping box should be used whenever possible. NexAloT shall pay for the return of the product to the customer's location. In case of expedited shipping request, an extra service charge shall be assessed and the customer is responsible for this extra return shipping charge.

1. Customers should enclose the "NexAloT RMA Service Form" with the returned products.
2. Customers need to write down all the information related to the problem on the " NexAloT RMA Service Form " when applying for the RMA service; information will help to understand the problem, including the fault description, on-screen messages, and pictures if possible.
3. Customers could send back the faulty product with or without the accessories and key parts such as the CPU and DIMM. If the key parts are included, please be noted clearly within the return form. NexAloT takes no responsibility for the parts which are not listed in the return form.
4. Customers hold the responsibility to ensure that the packing of defective products is durable enough to be resistant against further damage due to the transportation; damage caused by transportation is treated as " Out of Warranty " under our Warranty specification.
5. RMA product(s) returned by NexAloT to any location other than the

customer registered delivery address will incur an extra shipping charge, the customer is responsible for paying the extra shipping charges, duties, and taxes of this shipment.

Product Repairing

1. NexAloT will repair defective products covered under this limited warranty that are returned to NexAloT; if products do prove to be defective, they will be repaired during their warranty period unless other warranty terms have been specified.
2. NexAloT owns all parts removed from repaired products.
3. NexAloT will use parts made by various manufacturers in performing the repair.
4. The repaired products will be warranted subjected to the original warranty coverage and period only.
5. For products returned as defective but, proved to be no defect/fault after the RMA process, NexAloT reserves the right to claim for a NDF (No Defect Found) Service Charge.
6. NexAloT will issue RMA Report which included Repair Detailed Information to the customer when the defective products were repaired and returned.
7. In addition to the above, NexAloT may authorize Independent/Third-party suppliers to repair the defective products for NexAloT.

Out Of Warranty Service

There will be a service charge from NexAloT for the “Out Of Warranty” product service; they are the Basic Diagnostic Service Fee and the Advanced Component Replacement Fee respectively. And, if the product can not be repaired, NexAloT will either return the product to the customer or, just scrap it, followed by customer’s instruction.

1. Testing and Parts Replacement

NexAloT will have the following Handling Charges for those OoW products that returned:

- a. Basic Labor Cost and Testing Fee: as Table listed.
 - b. Parts Fee: NexAloT will charge for main IC chipsets such as the N.B., S.B., Super-IO, LAN, Sound, Memory, and so on.
 - c. 3rd-party Device Fee: products replacement for CPU, DIMM, HDD, Chassis, and UPS.
2. Out of Warranty product will have a three months warranty for the fixed issues. If the product failed with different problem within 3 months, they will still incur the service charge of “Out of Warranty” .
3. Out of Warranty “products will not be repaired without a signed PI from the customer, the agreement of the repair process.

Add-on card, 3rd Party Device and board level repair cost higher than new product prices, customer can abandon to sign PI to repair and, please contact with sales to buy new products.

Safety Information

Before installing and using the device, note the following precautions:

- Read all instructions carefully.
- Do not place the unit on an unstable surface, cart, or stand.
- Follow all warnings and cautions in this manual.
- When replacing parts, ensure that your service technician uses parts specified by the manufacturer.
- Avoid using the system near water, in direct sunlight, or near a heating device.
- The load of the system unit does not solely rely for support from the rackmounts located on the sides. Firm support from the bottom is highly necessary in order to provide balance stability.
- The computer is provided with a battery-powered real-time clock circuit. There is a danger of explosion if battery is incorrectly replaced. Replace only with the same or equivalent type recommended by the manufacturer. Discard used batteries according to the manufacturer's instructions.

Installation Recommendations

Ensure you have a stable, clean working environment. Dust and dirt can get into components and cause a malfunction. Use containers to keep small components separated.

Adequate lighting and proper tools can prevent you from accidentally damaging the internal components. Most of the procedures that follow require only a few simple tools, including the following:

- A Philips screwdriver
- A flat-tipped screwdriver
- A grounding strap
- An anti-static pad

Using your fingers can disconnect most of the connections. It is recommended that you do not use needle-nose pliers to disconnect connections as these can damage the soft metal or plastic parts of the connectors.

Safety Precautions

1. Read these safety instructions carefully.
2. Keep this User Manual for later reference.
3. Disconnect this equipment from any AC outlet before cleaning. Use a damp cloth. Do not use liquid or spray detergents for cleaning.
4. For plug-in equipment, the power outlet socket must be located near the equipment and must be easily accessible.
5. Keep this equipment away from humidity.
6. Put this equipment on a stable surface during installation. Dropping it or letting it fall may cause damage.
7. The openings on the enclosure are for air convection to protect the equipment from overheating. **DO NOT COVER THE OPENINGS.**
8. Make sure the voltage of the power source is correct before connecting the equipment to the power outlet.
9. Place the power cord in a way so that people will not step on it. Do not place anything on top of the power cord. Use a power cord that has been approved for use with the product and that it matches the voltage and current marked on the product's electrical range label. The voltage and current rating of the cord must be greater than the voltage and current rating marked on the product.
10. All cautions and warnings on the equipment should be noted.
11. If the equipment is not used for a long time, disconnect it from the power source to avoid damage by transient overvoltage.
12. Never pour any liquid into an opening. This may cause fire or electrical shock.
13. Never open the equipment. For safety reasons, the equipment should be opened only by qualified service personnel.
14. If one of the following situations arises, get the equipment checked by service personnel:
 - a. The power cord or plug is damaged.
 - b. Liquid has penetrated into the equipment.
 - c. The equipment has been exposed to moisture.
 - d. The equipment does not work well, or you cannot get it to work according to the user's manual.
 - e. The equipment has been dropped and damaged.
 - f. The equipment has obvious signs of breakage.
15. Do not place heavy objects on the equipment.
16. The unit uses a three-wire ground cable which is equipped with a third pin to ground the unit and prevent electric shock. Do not defeat the purpose of this pin. If your outlet does not support this kind of plug, contact your electrician to replace your obsolete outlet.
17. **CAUTION: DANGER OF EXPLOSION IF BATTERY IS INCORRECTLY REPLACED. REPLACE ONLY WITH THE SAME OR EQUIVALENT TYPE RECOMMENDED BY THE MANUFACTURER. DISCARD USED BATTERIES ACCORDING TO THE MANUFACTURER'S INSTRUCTIONS.**

Technical Support and Assistance

1. For the most updated information of NexAloT products, visit NexAloT's website at www.nexaiot.com.
2. For technical issues that require contacting our technical support team or sales representative, please have the following information ready before calling:
 - Product name and serial number
 - Detailed information of the peripheral devices
 - Detailed information of the installed software (operating system, version, application software, etc.)
 - A complete description of the problem
 - The exact wordings of the error messages

Warning!

1. Handling the unit: carry the unit with both hands and handle it with care.
2. Maintenance: to keep the unit clean, use only approved cleaning products or clean with a dry cloth.
3. CFast: Turn off the unit's power before inserting or removing a CFast storage card.

Conventions Used in this Manual



Warning:

Information about certain situations, which if not observed, can cause personal injury. This will prevent injury to yourself when performing a task.



Caution:

Information to avoid damaging components or losing data.



Note:

Provides additional information to complete a task easily.

Global Service Contact Information

Headquarters

NEXCOM International Co., Ltd.

9F, No. 920, Zhongzheng Rd.,
Zhonghe District, New Taipei City, 23586,
Taiwan, R.O.C.
Tel: +886-2-8226-7786
Fax: +886-2-8226-7782
www.nexcom.com

Asia

Taiwan

NexAIoT Headquarters

Industry 4.0 and Cloud Services

12F, No.922, Zhongzheng Rd.,
Zhonghe District, New Taipei City,
23586, Taiwan, R.O.C.
Tel: +886-2-8226-7796
Fax: +886-2-8226-7926
Email: sales@nexaiot.com
www.nexaiot.com

NexAIoT Co., Ltd.

Taichung Office

16F, No.250, Sec.2, Chongde Rd.,
Beitun District,
Taichung City, 406, Taiwan, R.O.C.
Tel: +886-4-2249-1179
Fax: +886-4-2249-1172
Email: jacobhuang@nexaiot.com
www.nexaiot.com

NexCOBOT Taiwan Co., Ltd.

13F, No.916, Zhongzheng Rd.,
Zhonghe District,
New Taipei City, 23586, Taiwan, R.O.C.
Tel: +886-2-8226-7786
Fax: +886-2-8226-7926
Email: jennyshern@nexcobot.com
www.nexcobot.com

GreenBase Technology Corp.

13F, No.922, Zhongzheng Rd.,
Zhonghe District,
New Taipei City, 23586, Taiwan, R.O.C.
Tel: +886-2-8226-7786
Fax: +886-2-8226-7900
Email: vivianlin@nexcom.com.tw
www.nexcom.com.tw

DivioTec Inc.

19F-1A, No.97, Sec.4, ChongXin Rd.,
Sanhong District,
New Taipei City, 24161, Taiwan, R.O.C.
Tel: +886-2-8976-3077
Email: sales@diviotec.com
www.diviotec.com

AIoT Cloud Corp.

13F, No.922, Zhongzheng Rd.,
Zhonghe District,
New Taipei City, 23586, Taiwan, R.O.C.
Tel: +886-2-8226-7786
Fax: +886-2-8226-7782
Email: alantsai@aiotcloud.net
www.aiotcloud.dev

EMBUX TECHNOLOGY CO., LTD.

13F, No.916, Zhongzheng Rd.,
Zhonghe District,
New Taipei City, 23586, Taiwan, R.O.C.
Tel: +886-2-8226-7786
Fax: +886-2-8226-7782
Email: info@embux.com
www.embux.com

TMR TECHNOLOGIES CO., LTD.

13F, No.916, Zhongzheng Rd.,
Zhonghe District,
New Taipei City, 23586, Taiwan, R.O.C.
Tel: +886-2-8226-7786
Fax: +886-2-8226-7782
Email: services@tmrtek.com
www.tmrtek.com

China NEXSEC Incorporated

201, Floor 2, Unit 2, Building 15, Yard 3,
Gaolizhang Road, Haidian District,
Beijing, 100094, China
Tel: +86-10-5704-2680
Fax: +86-10-5704-2681
Email: marketing@nexsec.cn
www.nexsec.cn

NEXCOM Shanghai

Room 406-407, Building C, No 154, Lane 953,
Jianchuan Road, Minhang District,
Shanghai, 201108, China
Tel: +86-21-5278-5868
Fax: +86-21-3251-6358
Email: sales@nexcom.cn
www.nexcom.cn

NEXCOM Surveillance Technology Corp.

Floor 8, Building B3, Xiufeng Industrial Zone,
GanKeng Community, Buji Street,
LongGang District,
ShenZhen, 518112, China
Tel: +86-755-8364-7768
Fax: +86-755-8364-7738
Email: steveyang@nexcom.com.tw
www.nexcom.cn

NEXGOL Chongqing

1st Building No.999,
Star Boulevard, Yongchuan Dist,
Chongqing City, 402160, China
Tel: +86-23-4960-9080
Fax: +86-23-4966-5855
Email: sales@nexgol.com.cn
www.nexcom.cn

Beijing NexGemo Technology Co.,Ltd.

Room 205, No.1, Fazhan Rd.,
Beijing International Information Industry Base,
Changping District,
Beijing, 102206, China
Tel: +86-10-8072-2025
Fax: +86-10-8072-2022
Email: sales@nexgemo.cn
www.nexgemo.com

Japan

NEXCOM Japan

9F, Tamachi Hara Bldg.,
4-11-5, Shiba Minato-ku,
Tokyo, 108-0014, Japan
Tel: +81-3-5419-7830
Fax: +81-3-5419-7832
Email: sales@nexcom-jp.com
www.nexcom-jp.com

America USA NEXCOM USA

46665 Fremont Blvd.,
Fremont CA 94538, USA
Tel: +1-510-656-2248
Fax: +1-510-656-2158
Email: sales@nexcom.com
www.nexcomusa.com

Package Contents

APPC 1260T-A01

Description	Specification	Qty	Part Number
TERMINAL BLOCKS 3P DINKLE:2ESDVM-03P	ASSY 5.08mm FEMALE 90D GREEN	1	4NCPF00312X00
TERMINAL BLOCKS 2P PHOENIX CONTACT:1803578	ASSY 3.81mm MALE 90D GREEN	1	4NCPM00203X00
PANEL PC WALL MOUNT BRACKETS FOR APPC 1X40T VER:B ASDA	15.2x17.5x15.1mm	12	5040460006X00
STYLUS PEN PENMOUNT:9011	L:133.89mm	1	5070000020X00
SATA M2 BRACKET FOR IPPC 1611-C11 VER:A CHYUAN-JYH	22x10x2.05mm SECC T=1.0mm	1	5040410217X00
I HEAD SCREW LONG FEI:I2.5x4.5	M2.5x4.5L ISO NI	1	50311T0113X00
I HEAD SCREW LONG FEI:I3x3 ISO+NYLOK BLACK	I3x3 ISO+NYLOK BLACK	2	50311F0396X00
I HEAD SCREW LONG FEI:I2x4 NYLOK NIGP	I2x4 NI NYLOK	1	50311F0294X00
COPPER POST FOR CPS50 SERIES VER:A LONG FEI	WITH FEMALE/MALE (FEMALE)6.6mmx(MALE)4mmxM3	1	50344C0378X00

APPC 1560-A01/1660-A01/1760-A01/1960-A01/2160-A01

Description	Specification	Qty
TERMINAL BLOCKS 3P	ASSY 5.08mm FEMALE 90D GREEN	1
TERMINAL BLOCKS 2P	ASSY 3.81mm MALE 90D GREEN	1
PANEL PC WALL MOUNT BRACKETS	15.2x17.5x15.1mm	12
STYLUS PEN PENMOUNT:9011	L:133.89mm	1
SATA M2 BRACKET	22x10x2.05mm SECC T=1.0mm	1
I HEAD SCREW LONG FEI:I2.5x4.5	M2.5x4.5L ISO NI	1
I HEAD SCREW LONG FEI:I3x3 ISO+NYLOK BLACK	I3x3 ISO+NYLOK BLACK	2
I HEAD SCREW LONG FEI:I2x4 NYLOK NIGP	I2x4 NI NYLOK	1
COPPER POST	WITH FEMALE/MALE (FEMALE)6.6mmx(MALE)4mmxM3	1



Note that the wall mount bracket for APPC 1260T-A01 is not compatible with APPC 1560-A01/1660-A01/1760-A01/1960-A01/2160-A01.

Ordering Information

The following information below provides ordering information for the Applied Panel PC series.

Barebone

- **APPC1260T-A01 (P/N: 10IA0126000X0)**
12.1" XGA, 5W-R, N97, DDR5 8GB, 24V, 2USB3, 2LAN, 1DP, 1USBC, 3COM, 1LINE-OUT, W/O EXPANSION
- **APPC 1560-A01 (P/N: 10IA1560C01XE)**
15" XGA, 5W-R, N97,DDR5 8GB, 24V, 2USB3, 2LAN, 1DP, 1USBC, 3COM, 1LINE-OUT
- **APPC1660-A01 (P/N: 10IA1660C01XE)**
15.6" FHD, P-Cap, N97, DDR5 8GB,24V, 2USB3, 2LAN, 1DP, 1USBC, 3COM, 1LINE-OUT
- **APPC 1760-A01 (P/N: 10IA1760C01XE)**
17" SXGA 5W-R, N97, DDR5 8GB, 24V, 2USB3,2LAN,1DP, 1USBC, 3COM, 1LINE-OUT
- **APPC 1960-A01 (P/N: 10IA1960C01XE)**
19" XGA, 5W-R, N97, DDR5 8GB,24V, 2USB3, 2LAN, 1DP, 1USBC, 3COM, 1LINE-OUT
- **APPC 2160-A01 (P/N: 10IA2160C01XE)**
21.5" FHD, P-Cap, N97, DDR5 8GB,24V, 2USB3, 2LAN, 1DP, 1USBC, 3COM, 1LINE-OUT

Optional

24V, 60W AC/DC power adapter w/o power cord (P/N:7400060054X00)

CHAPTER 1: PRODUCT INTRODUCTION

APPC 1260T-A01

Overview



Key Features

- 4:3 12" XGA LED Panel PC with 5-Wire resistive touch
- Intel® Processor N97, Quad Core 2.0GHz, 6M Cache
- 1 x DDR5 4800MHz with 8GB installed by default
- Support multi- Display for DP; 1 x USB-C (DP Alt. Mode)
- Dual Intel® 2.5GbE LAN ports
- 2 x USB 3.2, 1 x Line out, 2 x RS-232/422/485, 1 x RS-232
- Support 1 x M.2 B Key 2242 (SATA) for storage
- IP65 compliant front panel
- Mounting support: panel/wall/stand/VESA (100mm x 100mm)
- DC power input 24V DC

APPC 1560-A01

Overview



Key Features

- 4:3 15" XGA fanless LED panel computer
- Intel® Processor N97, Quad Core 2.0GHz, 6M Cache
- Flush panel by 5-wire touch screen with slim bezel
- 1 x DDR5 4800MHz with default 8GB installed
- Additional 2nd Display: 1 x DP / 1 x USB-C
- Dual Intel® 2.5GbE LAN ports, 2 x USB 3.2, 1 x Line out
- 2 x RS-232/422/485, 1 x RS-232, 1 x Mini PCIe, 2 x M.2
- IP65 compliant front panel
- Mounting support: panel/wall/stand/VESA 100mm x 100mm
- DC power input 24V DC

APPC 1660-A01

Overview



Key Features

- 16:9 21.5" FHD fanless LED panel computer
- Intel® Processor N97, Quad Core 2.0GHz, 6M Cache
- 10 points P-Cap multi-touch with zero bezel flush front design
- 1 x DDR5 4800MHz with default 8GB installed
- Additional 2nd Display: 1 x DP/1 x USB-C
- Dual Intel® 2.5GbE LAN ports, 2 x USB 3.2, 1 x Line out
- 2 x RS-232/422/485, 1 x RS-232, 1 x Mini PCIe, 2 x M.2
- IP65 compliant front panel
- Mounting support: panel/wall/stand/VESA 100mm x 100mm
- DC power input 24V DC

APPC 1760-A01

Overview



Key Features

- 4:3 17" SXGA fanless LED panel computer
- Intel® Processor N97, Quad Core 2.0GHz, 6M Cache
- Flush panel by 5-wire touch screen with slim bezel
- 1 x DDR5 4800MHz with default 8GB installed
- Additional 2nd Display: 1 x DP/1 x USB-C
- Dual Intel® 2.5GbE LAN ports, 2 x USB 3.2, 1 x Line out
- 2 x RS-232/422/485, 1 x RS-232, 1 x Mini PCIe, 2 x M.2
- IP65 compliant front panel
- Mounting support: panel/wall/stand/VESA 100mm x 100mm
- DC power input 24V DC

APPC 1960-A01

Overview



Key Features

- 4:3 19" SXGA fanless LED panel computer
- Intel® Processor N97, Quad Core 2.0GHz, 6M Cache
- Flush panel by 5-wire touch screen with slim bezel
- 1 x DDR5 4800MHz with default 8GB installed
- Additional 2nd Display: 1 x DP/1 x USB-C
- Dual Intel® 2.5GbE LAN ports, 2 x USB 3.2, 1 x Line out
- 2 x RS-232/422/485, 1 x RS-232, 1 x Mini PCIe, 2 x M.2
- IP65 compliant front panel
- Mounting support: panel/wall/stand/VESA 100mm x 100mm
- DC power input 24V DC

APPC 2160-A01

Overview



Key Features

- 16:9 21.5" FHD fanless LED panel computer
- Intel® Processor N97, Quad Core 2.0GHz, 6M Cache
- 10 points P-Cap multi-touch with zero bezel flush front design
- 1 x DDR5 4800MHz with default 8GB installed
- Additional 2nd Display: 1 x DP/1 x USB-C
- Dual Intel® 2.5GbE LAN ports, 2 x USB 3.2, 1 x Line out
- 2 x RS-232/422/485, 1 x RS-232, 1 x Mini PCIe, 2 x M.2
- IP65 compliant front panel
- Mounting support: panel/wall/stand/VESA 100mm x 100mm
- DC power input 24V DC

Specifications

APPC 1260T-A01

Panel

- LCD size: 12.1", 4:3
- Resolution: XGA 1024 x 768
- Luminance: 500cd/m²
- Contrast ratio: 700:1
- LCD Color: 16.7M
- Viewing angle: 70(U), 70(D), 80(L), 80(R)
- Backlight: LED

Touch

- 5-wire resistive (flush panel type)
- Light transmission: 80%
- Interface: USB

System

- CPU: Intel® processor N97 (embedded)
- BIOS: AMI BIOS
- Support TPM 2.0
- System memory: 1 x DDR5 SO-DIMM, 8G memory (pre-installed)
- Storage device:
 - 1 x Key B M.2 2242 (SATA)

Rear I/O interface

- Power button
- 1 x 2-pin remote power on/off Terminal Block

- 24V DC input with 3-pin Terminal Block
- 2 x USB 3.2 Type-A
- Ethernet: 2 x RJ45
- 1 x DP 1.4a, up to 4K@60Hz
- 1 x USB 3.2, Type-C
 - Support DP 1.4a; up to 4K@60Hz
- DB9 for COM1 & COM2
 - COM1: RS-232/422/485 auto flow control
 - COM2: RS-232/422/485 auto flow control
- 1 x DB9 for RS-232 support
- 1 x Line out

Ethernet

- LAN chip: dual Intel® I226-IT Gigabit LAN
- Ethernet interface: 10/100/1000/2500Base-T Ethernet compatible
- Support WoL and PXE

Audio

- HD audio codec: REALTEK ALC888S-VD
- Audio interface: Line out

Internal Slot

- 1 x Mini PCIe (PCIe x1, USB 2.0, SIM) for Wi-Fi/ FBI/ LTE
- 1 x Key B M.2 2242 (SATA) for storage
- 1 x Key B M.2 3042/ 3052 (PCIe x1, USB 3.2, USB 2.0, SIM) for 5G/LTE
- 1 x nano SIM card slot
- 1 x USB 2.0 Type-A

Mechanical & Environment

- Color Pantone black\RAL 15 00 front bezel w/ Pantone 400\C\RAL 090 80 10 metal style membrane and black silver PC box
- IP protection: IP65 front
- Mounting: panel/ wall/ stand/ VESA 100mm x 100mm
- Power
 - Power input: 24V DC \pm 20%
 - AT/ATX power mode (default: ATX)
 - Power adapter: optional AC to DC power adapter (24V DC, 60W)
- Vibration
 - 2G@sine, 5-500Hz, 1hr/axis (M.2 operating), IEC 60068-2-64
 - 2Grms@random condition, 5-500Hz, 1hr/axis (Non-operating), IEC 60068-2-64
- Shock
 - 20G@wall mount, half sine, 11ms, IEC 60068-2-27
- Temperature
 - Operating temperature: -10 °C~55 °C (Ambient with air flow)
 - Storage temperature: -20°C~75°C
- Operating humidity: 10%~90%, non-condensing (limits to be at 90% RH at max 50°C)
- Dimension: 317mm x 243mm x 62.5mm
- Weight: 3.7kg

Certifications

- CE approval
- FCC Class A

OS Support Lists

- Windows 11
- Windows 10, 64bit

APPC 1560-A01/APPC 1660-A01/APPC 1760-A01/APPC 1960-A01/APPC 2160-A01

APPC 1560-A01

Panel

- LCD size: 15", 4:3
- Resolution: XGA 1024 x 768
- Luminance: 350cd/m²
- Contrast ratio: 1000:1
- LCD Color: 16.7M
- Viewing angle: 89 (U), 89 (D), 89 (L), 89 (R)
- Backlight: LED

Touch

- 5-wire resistive (flush panel type)
- Light transmission: 80%
- Interface: USB

Mechanical & Environment

- Color Pantone black\RAL 15 00 front bezel w/ Pantone 400\RAL 090 80 Color: Pantone 400\RAL 090 80 10 aluminum front bezel and black silver PC box
- IP protection: IP65 front
- Mounting: panel/wall/stand/VESA 100mm x 100mm
- Power
 - Power input: 24V DC \pm 20%
 - AT/ATX power mode (default: ATX)
 - Power adapter: optional AC to DC power adapter (24V DC, 60W)

- Vibration
 - 2G@sine, 5~500Hz, 1hr/axis (M.2 operating), IEC 60068-2-64
 - 2Grms@random condition, 5-500Hz, 1hr/axis (Non-operating), IEC 60068-2-64
- Shock
 - 20G@wall mount, half sine, 11ms, IEC 60068-2-27
- Temperature
 - Operating temperature: 0°C~50° (Ambient with air flow)
 - Storage temperature: -20°C~75°C
- Operating humidity
 - 10%~90%, non-condensing (limits to be at 90% RH at max 50°C)

Dimension

- 358.1mm x 281.1mm x 62.35 mm

Weight

- 4.6kg

APPC 1660-A01

Panel

- LCD size: 15.6", 16:9
- Resolution: FHD 1920 x 1080
- Luminance: 400cd/m²
- Contrast ratio: 1000:1
- LCD Color: 16.7M
- Viewing angle: 89 (U), 89 (D), 89 (L), 89 (R)
- Backlight: LED

Touch

- Ten points P-Cap (projected capacitive touch)
- Touch light transmission: 85%
- Anti-scratch surface: 7H hardness
- Touch interface: USB

Mechanical & Environment

- Color Pantone black\RAL 15 00 front bezel w/ Pantone 400\RAL 090 80 Color: Pantone 400\RAL 090 80 10 aluminum front bezel and black silver PC box
- IP protection: IP65 front
- Mounting: panel/wall/stand/VESA 100mm x 100mm
- Power
 - Power input: 24V DC \pm 20%
 - AT/ATX power mode (default: ATX)
 - Power adapter: optional AC to DC power adapter (24V DC, 60W)

- Vibration
 - 2G@sine, 5~500Hz, 1hr/axis, IEC 60068 2-64
 - 2Grms@random condition, 5~500Hz, 0.5hr/axis, IEC 60068-2-64
- Shock
 - 20G@wall mount, half sine, 11ms, IEC 60068-2-27
- Temperature
 - Operating temperature: 0°C~50° (Ambient with air flow)
 - Storage temperature: -20°C~75°C
- Operating humidity
 - 10%~90%, non-condensing
 - (limits to be at 90% RH at max 50°C)

Dimension

- 388.1mm x 245.3mm x 58.8mm

Weight

- 4.61kg

APPC 1760-A01

Panel

- LCD size: 17", 4:3
- Resolution: SXGA 1280 x 1024
- Luminance: 400cd/m²
- Contrast ratio: 1000:1
- LCD Color: 16.7M
- Viewing angle: 80 (U), 80 (D), 85 (L), 85 (R)
- Backlight: LED

Touch

- 5-wire resistive (flush panel type)
- Light transmission: 78%
- Interface: USB

Mechanical & Environment

- Color Pantone black\RAL 15 00 front bezel w/ Pantone 400C\RAL 090 80 Color: Pantone 400C\RAL 090 80 10 aluminum front bezel and black silver PC box
- IP protection: IP65 front
- Mounting: panel/wall/stand/VESA 100mm x 100mm
- Power
 - Power input: 24V DC \pm 20%
 - AT/ATX power mode (default: ATX)
 - Power adapter: optional AC to DC power adapter (24V DC, 60W)

- Vibration
 - 2G@sine, 5~500Hz, 1hr/axis (M.2 operating), IEC 60068-2-6
 - 2Grms@random condition, 5-500Hz, 1hr/axis (Non-operating), IEC 60068-2-64
- Shock
 - 20G@wall mount, half sine, 11ms, IEC 60068-2-27
- Temperature
 - Operating temperature: 0°C~50° (Ambient with air flow)
 - Storage temperature: -20°C~75°C
- Operating humidity
 - 10%~90%, non-condensing (limits to be at 90% RH at max 50°C)

Dimension

- 391.8mm x 325.6mm x 63.65 mm

Weight

- 5.4kg

APPC 1960-A01

Panel

- LCD size: 19", 4:3
- Resolution: SXGA 1280 x 1024
- Luminance: 350cd/m²
- Contrast ratio: 1000:1
- LCD Color: 16.7M
- Viewing angle: 80 (U), 80 (D), 85 (L), 85 (R)
- Backlight: LED

Touch

- 5-wire resistive (flush panel type)
- Light transmission: 80%
- Interface: USB

Mechanical & Environment

- Color Pantone black\RAL 15 00 front bezel w/ Pantone 400\RAL 090 80 Color: Pantone 400\RAL 090 80 10 aluminum front bezel and black silver PC box
- IP protection: IP65 front
- Mounting: panel/wall/stand/VESA 100mm x 100mm
- Power
 - Power input: 24V DC \pm 20%
 - AT/ATX power mode (default: ATX)
 - Power adapter: optional AC to DC power adapter (24V DC, 60W)

- Vibration
 - 2G@sine, 5~500Hz, 1hr/axis (Panel Mounting operating), IEC 60068 2-64
 - 2Grms@random condition, 5~500Hz, 0.5hr/axis (Panel Mounting operating), IEC 60068-2-64
 - 1G@sine, 5~500Hz, 1hr/axis (VESA Mounting operating), IEC 60068 2-64
 - 1Grms@random condition, 5~500Hz, 0.5hr/axis (VESA Mounting operating), IEC 60068-2-64
- Shock
 - 20G@wall mount, half sine, 11ms, IEC 60068-2-27
- Temperature
 - Operating temperature: 0°C~50° (Ambient with air flow)
 - Storage temperature: -20°C~75°C
- Operating humidity
 - 10%~90%, non-condensing (limits to be at 90% RH at max 50°C)

Dimension

- 425.4mm x 350mm x 60.1 mm

Weight

- 6kg

APPC 2160-A01

Panel

- LCD size: 21.5", 16:9
- Resolution: : FHD 1920 x 1080
- Luminance: 500cd/m²
- Contrast ratio: 1000:1
- LCD Color: 16.7M
- Viewing angle: 89 (U), 89 (D), 89 (L), 89 (R)
- Backlight: LED

Touch

- Ten points P-Cap (projected capacitive touch)
- Touch light transmission: 85%
- Anti-scratch surface: 7H hardness
- Touch interface: USB

Mechanical & Environment

- Color Pantone black\RAL 15 00 front bezel w/ Pantone 400\C\RAL 090 80 Color: Pantone 400\C\RAL 090 80 10 aluminum front bezel and black silver PC box
- IP protection: IP65 front
- Mounting: panel/wall/stand/VESA 100mm x 100mm
- Power
 - Power input: 24V DC \pm 20%
 - AT/ATX power mode (default: ATX)
 - Power adapter: optional AC to DC power adapter (24V DC, 60W)

- Vibration
 - 2G@sine, 5~500Hz, 1hr/axis (Panel Mounting operating), IEC 60068 2-64
 - 2Grms@random condition, 5~500Hz, 0.5hr/axis (Panel Mounting operating), IEC 60068-2-64
 - 1G@sine, 5~500Hz, 1hr/axis (VESA Mounting operating), IEC 60068 2-64
 - 1Grms@random condition, 5~500Hz, 0.5hr/axis (VESA Mounting operating), IEC 60068-2-64
- Shock
 - 20G@wall mount, half sine, 11ms, IEC 60068-2-27
- Temperature
 - Operating temperature: 0°C~50° (Ambient with air flow)
 - Storage temperature: -20°C~75°C
- Operating humidity
 - 10%~90%, non-condensing (limits to be at 90%RH at max 40°C; limits to be at 44% RH at max 50°C)

Dimension

- 524.9mm x 321.2mm x 61.8mm

Weight

- 7.23kg

System

- CPU: Onboard Alder Lake N Intel® processor N97
- BIOS: AMI BIOS
- Support TPM 2.0
- System memory: 1 x DDR5 SO-DIMM, 8G memory (pre-installed)
- Storage device:
 - 1 x Key B M.2 2242 (SATA)

Rear I/O interface

- Power button
- 1 x 2-pin remote power on/off Terminal Block
- 24V DC input with 3-pin Terminal Block
- 2 x USB 3.2 Type-A
- Ethernet: 2 x RJ45
- 1 x DP 1.4a, up to 4K@60Hz
- 1 x USB 3.2, Type-C,
 - Support DP 1.4a; up to 4K@60Hz
- DB9 for COM1 & COM2
 - COM1: RS-232/422/485 auto flow control
 - COM2: RS-232/422/485 auto flow control
- 1 x DB9 for RS-232 support
- 1 x Line out

Ethernet

- LAN chip: dual Intel® I226-IT Gigabit LAN
- Ethernet interface: 10/100/1000/2500Base-T Ethernet compatible
- Support WoL and PXE

Audio

- HD audio codec: REALTEK ALC888S-VD

- Audio interface: Line out

Internal Slot

- 1 x Mini PCIe (PCIe x1, USB 2.0, SIM) for Wi-Fi/ FBI/ LTE
- 1 x Key B M.2 2242 (SATA) for storage
- 1 x Key B M.2 3042/ 3052 (PCIe x1, USB 3.0, USB 2.0, SIM) for 5G/LTE
- 1 x nano SIM card slot
- 1 x USB 2.0 Type-A

Certifications

- CE approval
- FCC Class A

OS Support Lists

- Windows 11
- Windows 10, 64bit

Knowing Your APPC Series

Rear Bottom

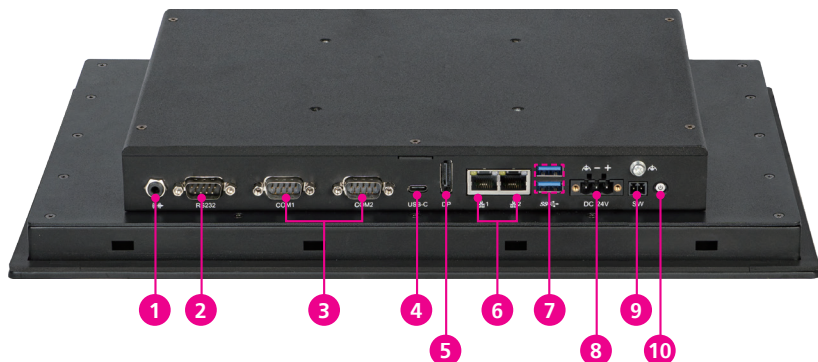

The form factor may vary depending on the model, but the I/O remains the same.

- 1 Line Out**
Used to connect an external audio device.
- 2 RS-232**
Used to connect an RS-232 compatible device.
- 3 COM Ports**
Used to connect RS-232/422/485 compatible devices.
- 4 USB Type-C**
Used to connect a USB 3.2 peripheral or a monitor that supports DP 1.4a Alt. mode.
- 5 DisplayPort 1.4a**
Used to connect a monitor with a DisplayPort 1.4a or lower interface.
- 6 LAN Ports**
Used to connect the system to a local area network.
- 7 USB 3.2**
Used to connect a USB 3.2 or lower peripheral.
- 8 24V DC Input**
Used to plug a DC power cord.
- 9 Remote Power**
Used to connect a remote to power on or off the system.
- 10 Power Button**
Press to power on or off the system.

Rear Bottom



Antenna Mounting Holes

The external antenna mounting holes are used to mount and connect optional Wi-Fi, LTE, or 5G antennas. Refer to [Installing an Antenna](#) for more details.



The form factor may vary depending on the model, but the I/O remains the same.

Rear Panel

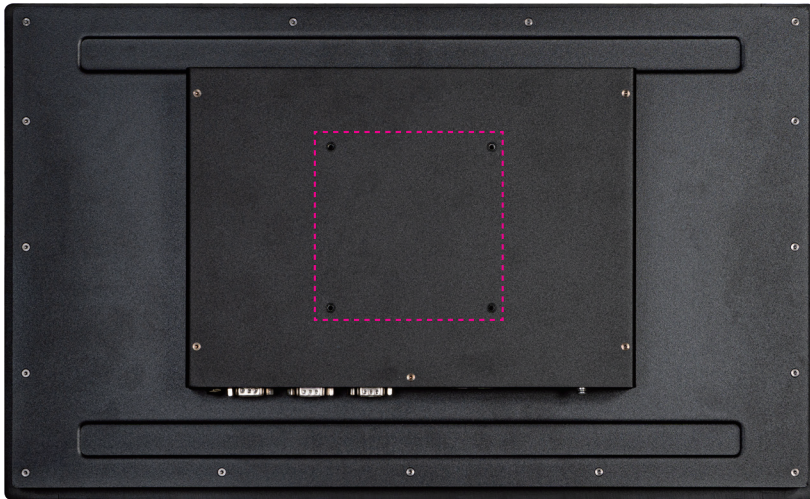

VESA Mounting Holes

The mounting hole specifications for this series of products adhere to the VESA standard. Refer to the red mark in the left image, which indicates the 100 x 100mm mounting hole pattern.



The form factor may vary depending on the model, but the mounting hole patterns remain the same.

Mechanical Dimensions

APPC 1260T-A01

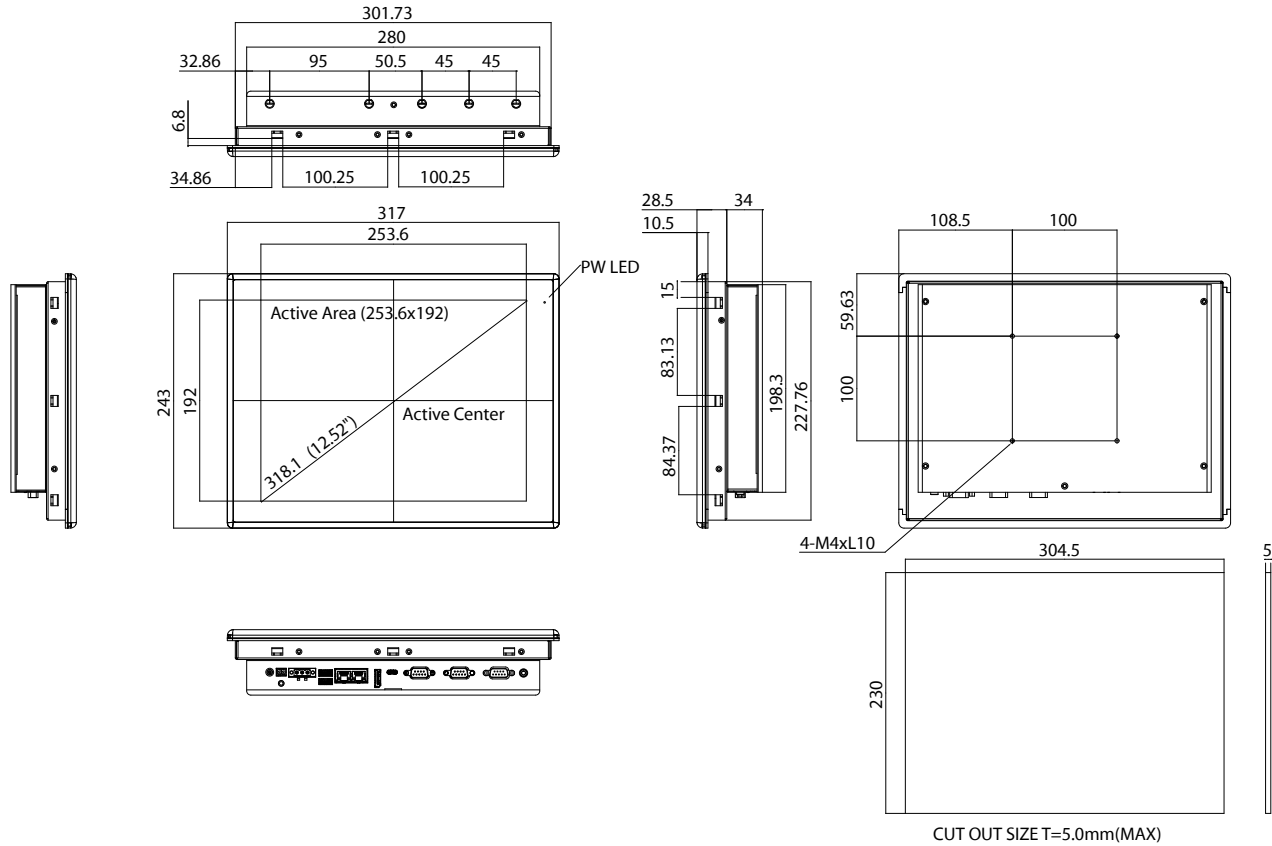

APPC 1560-A01

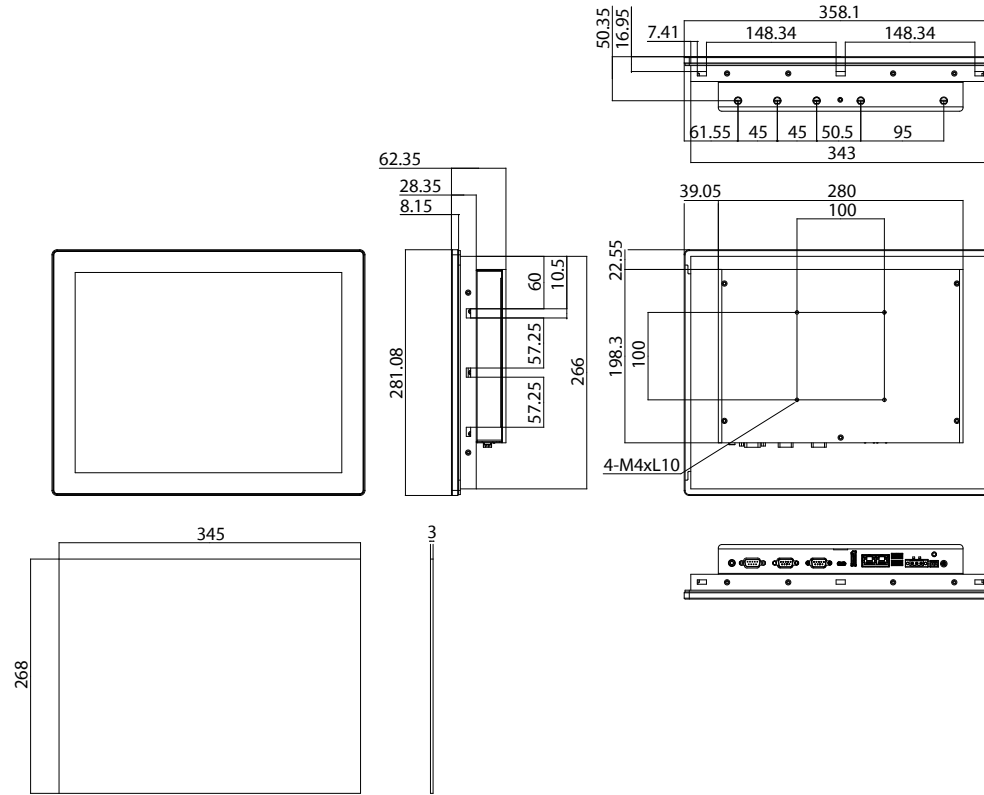

CUT OUT SIZE MAX T=3.0mm

APPC 1660-A01

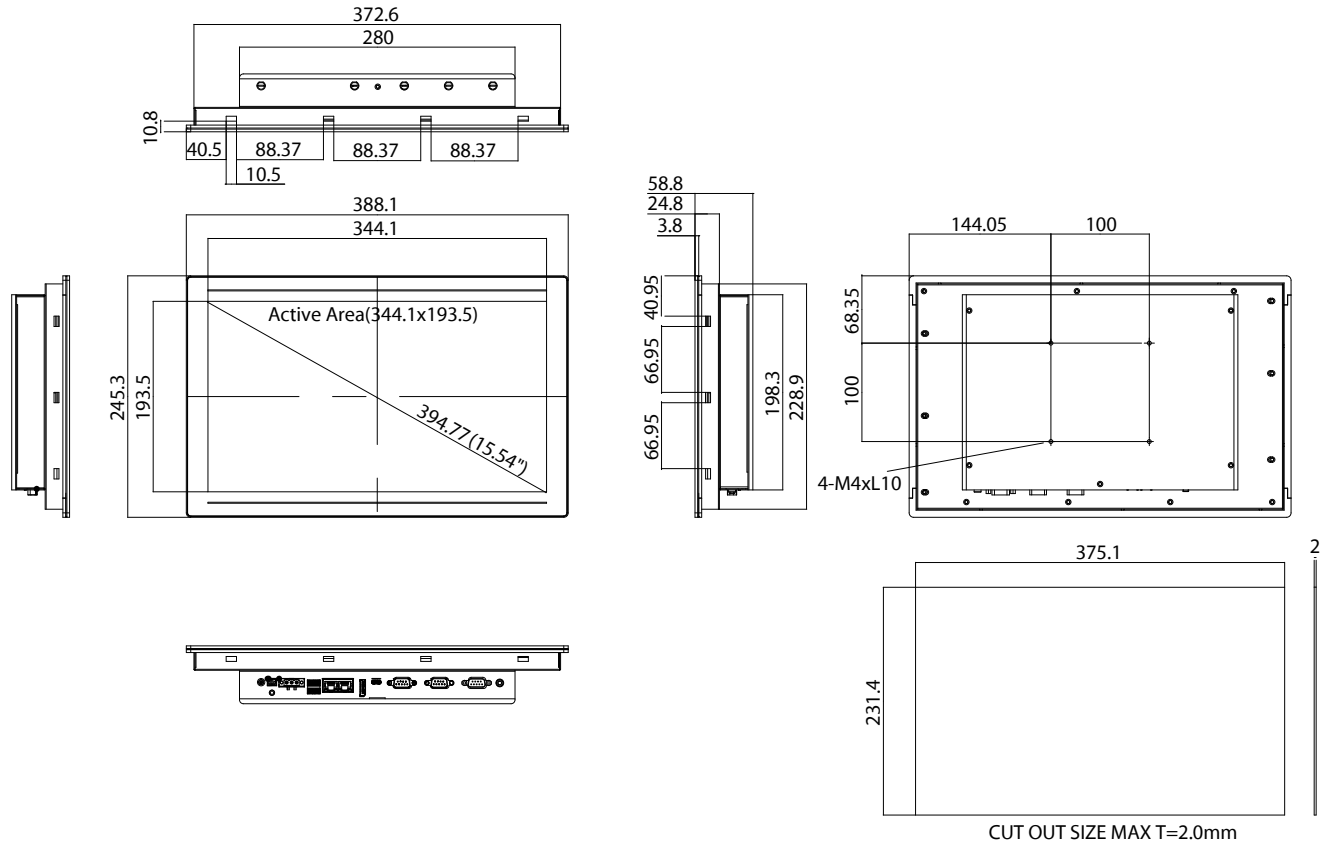

APPC 1760-A01

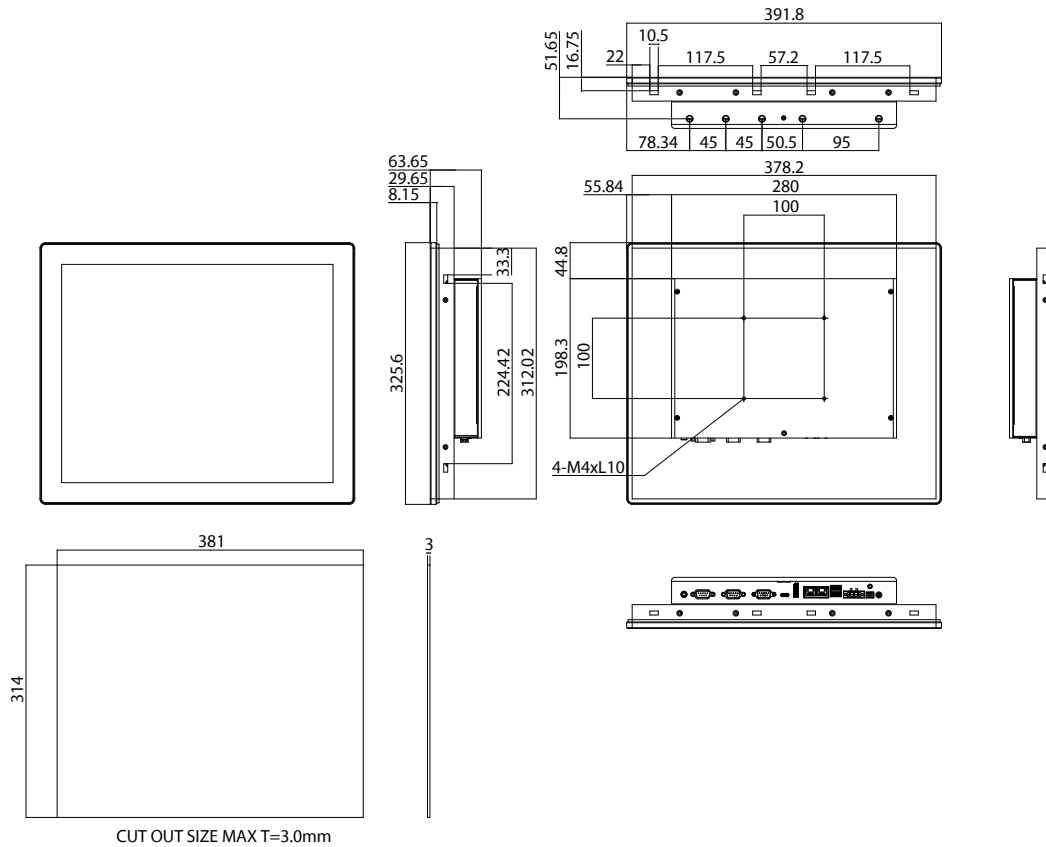

APPC 1960-A01

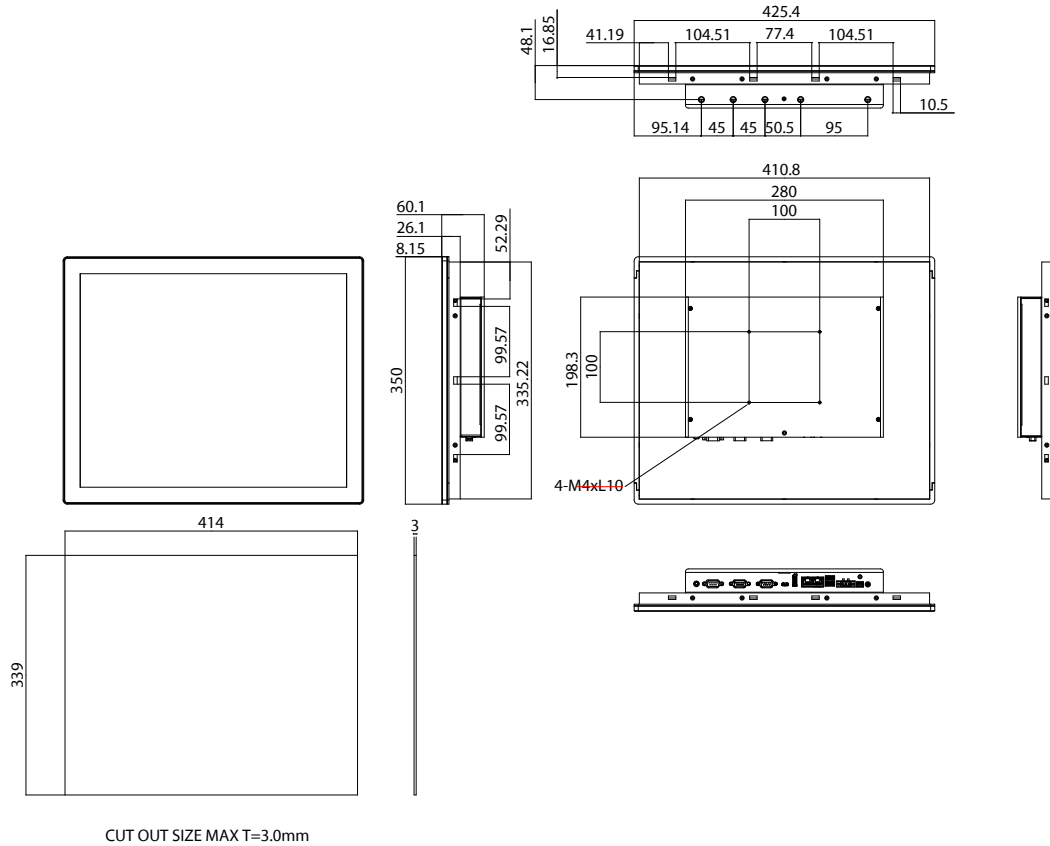

APPC 2160-A01

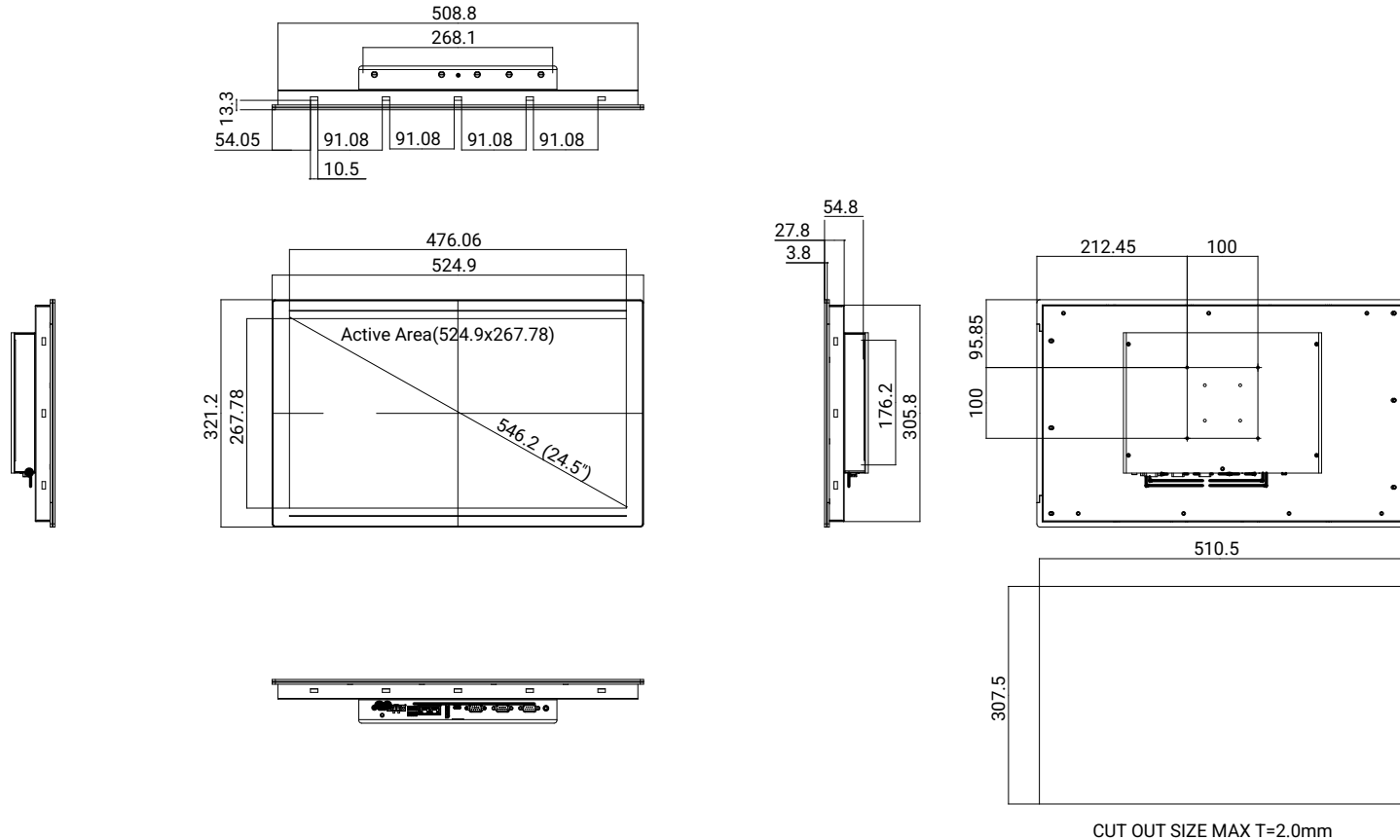

CHAPTER 2: JUMPERS AND CONNECTORS

This chapter describes how to set the jumpers and connectors on the APCC 1260T-A01 and APCC xx60-A01 series motherboard.

Before You Begin

- Ensure you have a stable, clean working environment. Dust and dirt can get into components and cause a malfunction. Use containers to keep small components separated.
- Adequate lighting and proper tools can prevent you from accidentally damaging the internal components. Most of the procedures that follow require only a few simple tools, including the following:
 - A Philips screwdriver
 - A flat-tipped screwdriver
 - A set of jewelers screwdrivers
 - A grounding strap
 - An anti-static pad
- Using your fingers can disconnect most of the connections. It is recommended that you do not use needle-nosed pliers to disconnect connections as these can damage the soft metal or plastic parts of the connectors.
- Before working on internal components, make sure that the power is off. Ground yourself before touching any internal components, by touching a metal object. Static electricity can damage many of the electronic components. Humid environments tend to have less static electricity than

dry environments. A grounding strap is warranted whenever danger of static electricity exists.

Precautions

Computer components and electronic circuit boards can be damaged by discharges of static electricity. Working on computers that are still connected to a power supply can be extremely dangerous.

Follow the guidelines below to avoid damage to your computer or yourself:

- Always disconnect the unit from the power outlet whenever you are working inside the case.
- If possible, wear a grounded wrist strap when you are working inside the computer case. Alternatively, discharge any static electricity by touching the bare metal chassis of the unit case, or the bare metal body of any other grounded appliance.
- Hold electronic circuit boards by the edges only. Do not touch the components on the board unless it is necessary to do so. Don't flex or stress the circuit board.
- Leave all components inside the static-proof packaging that they shipped with until they are ready for installation.
- Use correct screws and do not over tighten screws.

Jumper Settings

A jumper is the simplest kind of electric switch. It consists of two metal pins and a cap. When setting the jumpers, ensure that the jumper caps are placed on the correct pins. When the jumper cap is placed on both pins, the jumper is short. If you remove the jumper cap, or place the jumper cap on just one pin, the jumper is open.

Refer to the illustrations below for examples of what the 2-pin and 3-pin jumpers look like when they are short (on) and open (off).

Two-Pin Jumpers: Open (Left) and Short (Right)

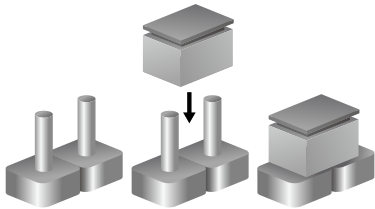

Three-Pin Jumpers: Pins 1 and 2 are Short

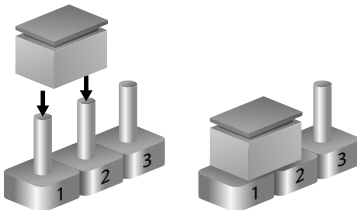

Locations of the Jumpers and Connectors

Top View

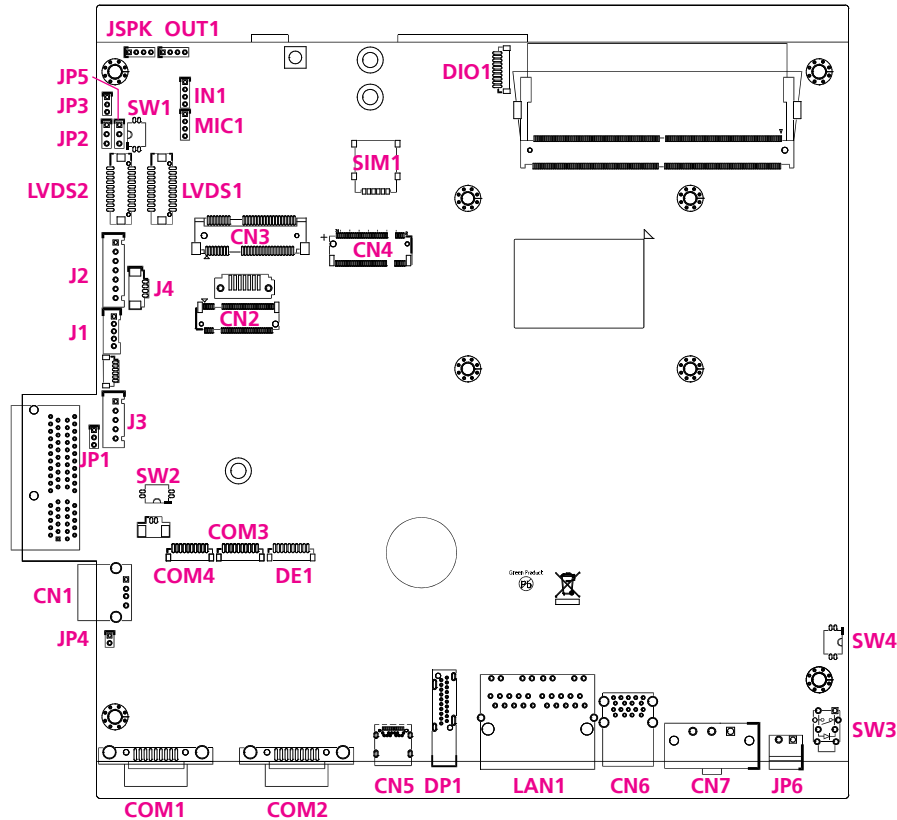

Jumpers

Resistance Touch 4/5 Wire Select

Connector location: JP1

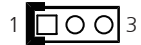

Pin	Settings
1-2 On	5 wire (default)
2-3 On	4 wire

Pin	Definition
1	NA
2	TOUCH_YU
3	SENSE

Panel VCC Power Select

Connector location: JP2



Pin	Definition	Description
1-2 On	VCC3	3.3V (default)
2-3 On	VCC5	5V

LVDS EDP Signal Select

Connector location: JP3

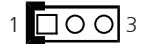

Pin	Settings
1-2 On	eDP
2-3 On	LVDS (default)

LCD Panel VDD Power Select

Connector location: JP5



Pin	Settings
1-2 On	3.3V
2-3 On	5V (default)

LCD Panel Power Requirements

15.6-inch Panel: 3.3V

21.5-inch Panel: 5V

23.8-inch Panel: 5V

Panel Backlight Control Select (CCFL/ PWM Mode)

Connector location: SW1

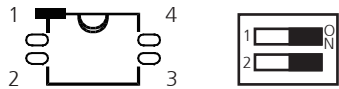

Mode	1-4 Pin	2-3 Pin	Description
CCFL	OFF	ON	
PWM	ON	OFF	Default

Clear CMOS

Connector location: SW2

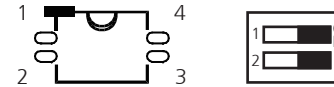

Mode	1-4 Pin	2-3 Pin	Description
Normal	OFF	OFF	Default
Clear CMOS	ON	OFF	Reset BIOS settings to default

AT/ATX Selection DIP Switch

Connector location: SW4

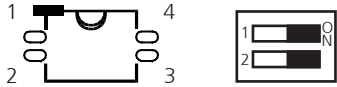

Mode	1-4 Pin	2-3 Pin	Description
AT	ON	ON	Power button enable
AT	ON	OFF	Power button disable
ATX	OFF	ON	Default

External I/O Interfaces

USB 3.2 Type-C

Connector location: CN5



Pin	Definition	Pin	Definition
A1	GND	B1	GND
A2	SSTX1+	B2	SSTX2+
A3	SSTX1-	B3	SSTX2-
A4	VBUS1	B4	VBUS3
A5	CC1	B5	CC2
A6	D1+	B6	D2+
A7	D1-	B7	D2-
A8	SBU1	B8	SBU2
A9	VBUS2	B9	VBUS4
A10	SSRX2-	B10	SSRX1-
A11	SSRX2+	B11	SSRX1+
A12	GND	B12	GND

USB 3.2 Type-A

Connector location: CN6

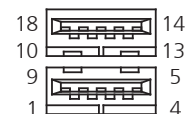

Pin	Definition	Pin	Definition
1	+5VSB	10	+5V
2	USB2_N2	11	USB2_N3
3	USB2_P2	12	USB2_P3
4	GND	13	GND
5	USB3_RXN0	14	USB3_RXN1
6	USB3_RXP0	15	USB3_RXP1
7	GND	16	GND
8	USB3_TXN0	17	USB3_TXN1
9	USB3_TXP0	18	USB3_TXP1
MH1	CHASIS_GND	MH2	CHASIS_GND
MH3	CHASIS_GND	MH4	CHASIS_GND

24V DC Power Input

Connector location: CN7

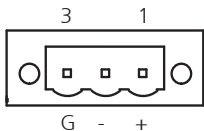

Pin	Definition
1	VCCIN
2	GND
3	Chassis GND

COM 1 Port

Connector interface: RS-232/422/485

Connector location: COM1

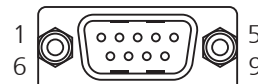

Pin	RS-232	RS-422	RS-485
1	COM1_DCD	COM1_TXD-	COM1_TXD- COM1_RXD-
2	COM1_RXD	COM1_TXD+	COM1_TXD+ COM1_RXD-
3	COM1_TXD	COM1_RXD+	Reserve
4	COM1_DTR	COM1_RXD-	Reserve
5	COM1_GND	COM1_GND	Reserve
6	COM1_DSR	COM1_RTS-	Reserve
7	COM1_RTS	COM1_RTS+	Reserve
8	COM1_CTS	COM1_CTS+	Reserve
9	COM1_RI	COM1_CTS-	Reserve

COM 2 Port

Connector interface: RS-232/422/485

Connector location: COM2

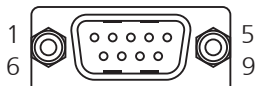

Pin	RS-232	RS-422	RS-485
1	COM2_DCD	COM2_TXD-	COM2_TXD- COM2_RXD-
2	COM2_RXD	COM2_TXD+	COM2_ TXD+COM2_RXD-
3	COM2_TXD	COM2_RXD+	Reserve
4	COM2_DTR	COM2_RXD-	Reserve
5	COM2_GND	COM2_GND	Reserve
6	COM2_DSR	COM2_RTS-	Reserve
7	COM2_RTS	COM2_RTS+	Reserve
8	COM2_CTS	COM2_CTS+	Reserve
9	COM2_RI	COM2_CTS-	Reserve

Reset Pin Header

Connector location: JP4



Pin	Definition	Type	Description
1	SYSRESETN	I	External Reset signal
2	GND		Digital GND

Remote Power

Connector location: JP6

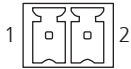

Pin	Definition
1	GND
2	PWRBTN#_J

DisplayPort 1.4a

Connector location: DP1

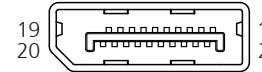

Pin	Definition	Pin	Definition
1	DPTX0P	11	GND
2	GND	12	DPTX3N
3	DPTX0N	13	CFG1
4	DPTX1P	14	CFG2
5	GND	15	DPAUXPCLK
6	DPTX1N	16	GND
7	DPTX2P	17	DPAUXNDAT
8	GND	18	HPD
9	DPTX2N	19	GND
10	DPTX3P	20	VCC3DP
MH1	GND	MH3	GND
MH2	GND	MH4	GND

LAN Ports

Connector location: LAN1

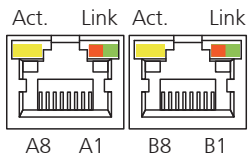

LAN Speed	Act. (Left)	Status
2.5GbE	Blinking yellow	Steady green
1GbE	Blinking yellow	Steady green
100/10Mbps	Blinking yellow	Steady orange

Pin	Definition	Pin	Definition
A1	LAN1MDI0P	B1	LAN2MDI0P
A2	LAN1MDI0N	B2	LAN2MDI0N
A3	LAN1MDI1P	B3	LAN2MDI1P
A4	LAN1MDI1N	B4	LAN2MDI1N
A5	LAN1TVCC1	B5	LAN2TVCC1
A6	GND	B6	GND
A7	LAN1MDI2P	B7	LAN2MDI2P
A8	LAN1MDI2N	B8	LAN2MDI2N
A9	LAN1MDI3P	B9	LAN2MDI3P
A10	LAN1MDI3N	B10	LAN2MDI3N
A11	LAN1LINK1000L	B11	LAN2LINK1000L
A12	LAN1LINK100L1	B12	LAN2LINK100L1
A13	LAN1LEDACTL	B13	LAN2LEDACTL
A14	LAN1LEDPWR	B14	LAN2LEDPWR
NH1	NC	NH2	NC
MH1	CHASIS_GND	MH2	CHASIS_GND

Power Button

Connector location: SW3



Pin	Definition	Pin	Definition
1	GND	2	ATX_PBT
4	GND	3	ATX_PBT
A1	PWRLED_N	C1	N16937976
MH1	NC	MH2	NC

Internal Connectors

USB 2.0

Connector location: CN1

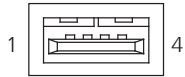

Pin	Definition
1	+5VSB
2	USB2_N0
3	USB2_P0
4	GND
MH1	CHASIS_GND
MH3	CHASIS_GND

M.2 Key B

Connector location: CN2

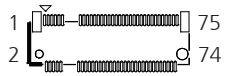

Pin	Definition	Pin	Definition
1	CFG1	2	3VSB
3	GND	4	3VSB
5	GND	6	PWROFF#
7	USB10P	8	M2TEDISL#
9	USB10N	10	NC
11	GND	12	NC
13	NC	14	NC
15	NC	16	NC
17	NC	18	NC
19	NC	20	NC

Pin	Definition	Pin	Definition
21	CFG0	22	NC
23	WAKE#	24	NC
25	NC	26	NC
27	GND	28	NC
29	PCIE_RX6N	30	NC
31	PCIE_RX6P	32	NC
33	GND	34	NC
35	PCIE_TX6N	36	NC
37	PCIE_TX6P	38	NC
39	GND	40	NC

Continued on next page

Pin	Definition	Pin	Definition
41	SATA_OBRXP	42	NC
43	SATA_OBRXN	44	NC
45	GND	46	NC
47	SATA_OBTXN	48	NC
49	SATA_OBTXP	50	RESET#
51	GND	52	SRCCLKREQ15
53	PCIE_CLK_15N	54	WAKE#
55	PCIE_CLK_15P	56	NC
57	GND	58	NC
59	NC	60	NC

Pin	Definition	Pin	Definition
61	NC	62	NC
63	NC	64	NC
65	NC	66	NC
67	NC	68	I_SUSCLK
69	CFG1	70	3VSB
71	GND	72	3VSB
73	GND	74	3VSB
75	CFG2		
MH1	GND	MH2	GND
NH1	NC	NH2	NC

Mini PCIe

Connector location: CN3

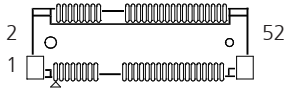

Pin	Definition	Pin	Definition
1	I_WAKEL	2	3VSB_MINILTE
3	NC	4	GND
5	NC	6	1V5_MINI
7	I_PCIECLKREQLO	8	UIM_PWR
9	GND	10	UIM_DATA
11	I_PCIECLKOUTNO	12	UIM_CLK
13	I_PCIECLKOUTPO	14	UIM_RESET
15	GND	16	UIM_VPP
17	NC	18	GND
19	NC	20	LTEDISL
21	GND	22	I_PLTRSTN
23	PCIESATARP	24	3VSB_MINILTE
25	PCIESATARN	26	GND
27	GND	28	1V5_MINI
29	GND	30	I_SMB3P3CLK

Pin	Definition	Pin	Definition
31	PCIESATATN	32	I_SMB3P3DATA
33	PCIESATATP	34	GND
35	GND	36	I_USB2N1
37	GND	38	I_USB2P1
39	3VSB_MINILTE	40	GND
41	3VSB_MINILTE	42	NC
43	GND	44	NC
45	NC	46	NC
47	NC	48	1V5_MINI
49	NC	50	GND
51	NC	52	3VSB_MINILTE
MH1	GND	MH2	GND
MH3	NC	NH4	NC
MH5	NC	MH6	GND
NH1	NC	NH2	NC

M.2 Key B

Connector location: CN4



Pin	Definition	Pin	Definition
1	M2BCONFIG3	2	M2LTEPWR
3	GND	4	M2LTEPWR
5	GND	6	SIO_M22POFF
7	I_USB2P0	8	SIO_M22DIS
9	I_USB2N0	10	NC
11	M2REFCLK-	12	NC
13	NC	14	NC
15	NC	16	NC
17	NC	18	NC
19	NC	20	NC

Pin	Definition	Pin	Definition
21	M2BCONFIG0	22	NC
23	LTEPEWAKE2	24	NC
25	NC	26	NC
27	GND	28	NC
29	USB32_P3_M2_RX_DN	30	UIM_RESET
31	USB32_P3_M2_RX_DP	32	UIM_CLK
33	GND	34	UIM_DATA
35	USB32_P3_M2_TX_DN	36	UIM_PWR
37	USB32_P3_M2_TX_DP	38	NC
39	GND	40	NC

Continued on next page

Pin	Definition	Pin	Definition
41	PCIE_P4_M2_RX_DN	42	NC
43	PCIE_P4_M2_RX_DP	44	NC
45	GND	46	NC
47	PCIE_P4_M2_TX_DN	48	NC
49	PCIE_P4_M2_TX_DP	50	I_PLTRSTN
51	GND	52	NC
53	CLK_PCIE_M2_N0	54	LTEPEWAKE1
55	CLK_PCIE_M2_P0	56	NC
57	GND	58	NC
59	NC	60	NC

Pin	Definition	Pin	Definition
61	NC	62	NC
63	NC	64	NC
65	NC	66	NC
67	M2LTERSTL	68	M2B_SUSCLK
69	M2BCONFIG1	70	M2LTEPWR
71	GND	72	M2LTEPWR
73	GND	74	M2LTEPWR
75	M2BCONFIG2		
MH1	GND	MH2	GND
NH1	NC	NH2	NC

COM Ports

Connector interface: RS-232

Connector location: COM3, COM4



COM3

Pin	Definition
1	Reserve
2	COM3_RXD
3	COM3_TXD
4	Reserve
5	Reserve
6	Reserve
7	COM3_RTS
8	COM3_CTS
9	Reserve

COM4

Pin	Definition
1	Reserve
2	COM4_RXD
3	COM4_TXD
4	Reserve
5	Reserve
6	Reserve
7	COM4_RTS
8	COM4_CTS
9	Reserve

Debug Port

Connector location: DE1



Pin	Definition
1	Digital GND
2	Platform RST#
3	eSPI CLK
4	eSPI CS#
5	eSPI IO3
6	eSPI IO2
7	eSPI IO1
8	eSPI IO0
9	eSPI RST#
10	Debug port 3.3V Power
MH1	Digital GND
MH2	Digital GND

DIO Pin Header

Connector location: DIO1



Pin	Definition	Pin	Definition
1	GND	2	NC
3	DI1	4	DO1
5	NC	6	DI2
7	DO2	8	NC
9	NC	10	GPIO_PWR

Panel LED

Connector location: J1

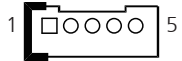

Pin	Definition
1	GND
2	VCC5
3	PWE_GND
4	3VSB
5	VCC5

LED	Status
Green	Off (S5)
Green	Sleep (S3)
Blue	On (S0)

Panel Backlight

Connector location: J2

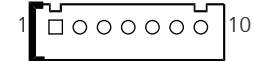

Pin	Definition
1	VCC5
2	12V
3	12V
4	BKCTRL
5	GND
6	GND
7	BKLEN

Resistance Touch

Connector location: J3

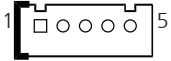

5 Wire

Pin	Definition	Pin	Definition
1	TOUCH_YD	1	TOUCH_YD
2	TOUCH_XR	2	TOUCH_XR
3	SENSE	3	SENSE
4	TOUCH_YU	4	TOUCH_YU
5	TOUCH_XL	5	TOUCH_XL

4 Wire

eDP Panel Backlight Control (Reserved)

Connector location: J4

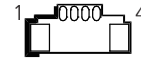

Pin	Definition
1	GND
2	PL_BKLTCTRL
3	GND
4	M_BKLTEN_R

Speaker

Connector location: JSPK



Pin	Definition
1	ROUTP
2	ROUTN
3	LOUTP
4	LOUTN

Line In

Connector location: IN1



Pin	Definition
1	LINE1-L1
2	AGND
3	LINEIN_JD
4	LINE1-R1

Line Out

Connector location: OUT1

1  4

Pin	Definition
1	LINE_OUT_LC
2	AGND
3	LINEOUT_JD
4	LINE_OUT_RC

LVDS

Connector location: LVDS1, LVDS2

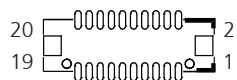

LVDS1

Pin	Definition	Pin	Definition
1	NC	2	NC
3	VDD	4	LVDS_DAT0P/ eDP_HPDP
5	LVDS_DAT3P	6	LVDS_DAT0N
7	LVDS_DAT3N	8	VDD
9	GND	10	LVDS_DAT1P/ eDP_TX1P
11	LVDS_CLK1P/ eDP_AUXP	12	LVDS_DAT1N/ eDP_TX1P
13	LVDS_CLK1N/eDP_AUXN	14	GND
15	GND	16	12V
17	LVDS_DAT2P/ eDP_TX0P	18	12V
19	LVDS_DAT2N/ eDP_TX0N	20	GND

LVDS2

Pin	Definition	Pin	Definition
1	CH_GPIO2	2	CH_GPIO3
3	VCCLCD	4	LVDS_DAT4P
5	LVDS_DAT7P	6	LVDS_DAT4N
7	LVDS_DAT07N	8	VCCLCD
9	GND	10	LVDS_DAT5P
11	LVDS_CLK2P	12	LVDS_DAT5N
13	LVDS_CLK2N	14	GND
15	GND	16	V_INV
17	LVDS_DAT6P	18	V_INV
19	LVDS_DAT6N	20	GND

Mic In

Connector location: MIC1

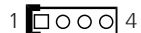

Pin	Definition
1	MIC_OUT-L
2	AGND
3	MIC_JD
4	MIC_OUT-R

nano-SIM

Connector location: SIM1

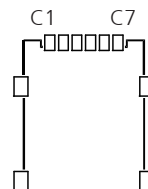

Pin	Definition
C1	UIM_PWR
C2	UIM_RESET
C3	UIM_SIM_CLK
C5	GND
C6	UIM_VPP
C7	UIM_DATA
MH1	GND
MH2	GND
MH3	GND
MH4	GND

CHAPTER 3: SYSTEM SETUP

Removing the Rear Cover



Prior to removing the rear cover, make sure the unit's power is off and disconnected from the power sources to prevent electric shock or system damage.



The form factor shown in this chapter may vary because it uses one of the APPC xx60 series devices as an example, but the installation process remains the same.

- Remove the 6 screws from the rear cover.

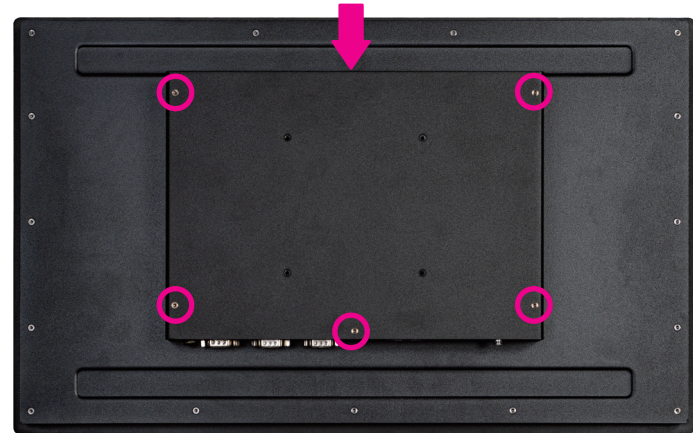

Replacing an SO-DIMM memory module

1. Remove the rear cover before installing the SO-DIMM memory module.
2. The memory module and thermal pads are pre-installed.
3. To replace the memory module, gently push the ejector tabs on both sides of the socket to release the module. The memory module will unlock and pop up at an approximately 30-degree angle.

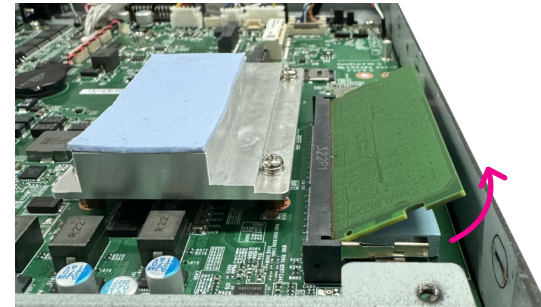
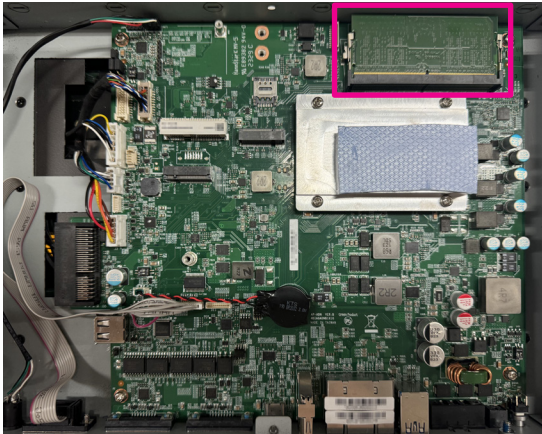

4. Carefully remove the memory module, ensuring the thermal pads remain in their original position.

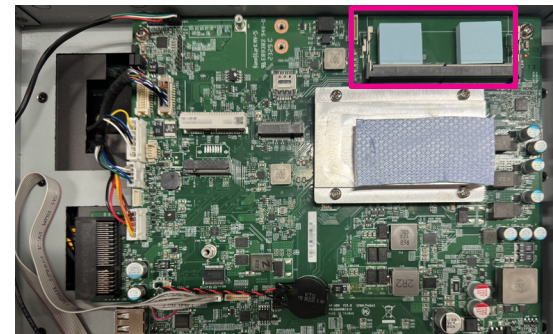

5. Insert the module into the socket at an approximately 30-degree angle until the gold-plated connector on the edge of the module is fully inserted into the socket. Push the module down toward the motherboard until a click is heard. The ejector tabs on both sides of the socket should snap into place, securely locking the memory module.

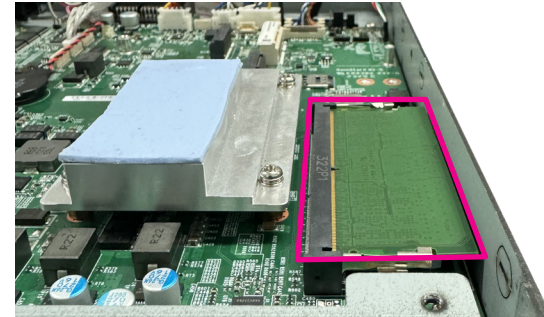
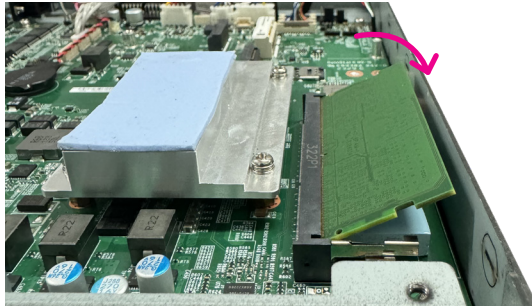

Installing a Wireless LAN Module in a Mini PCIe Slot

1. Refer to the image below to install the Mini PCIe bracket into the wireless LAN module if the module is half size.
2. Remove the rear cover before installing the wireless LAN module, then locate the Mini PCIe slot on the motherboard.

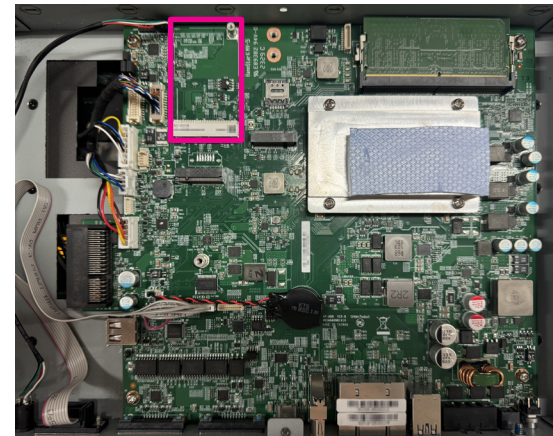
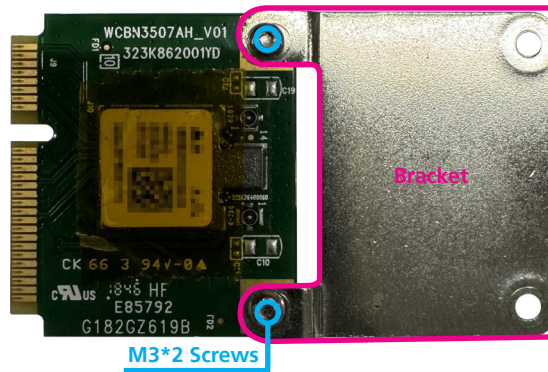

3. Insert the WLAN module into the Mini PCIe slot at a 45-degree angle until the gold-plated connector on the edge of the module is fully inserted into the slot.



4. Push the module down and secure it with a screw.

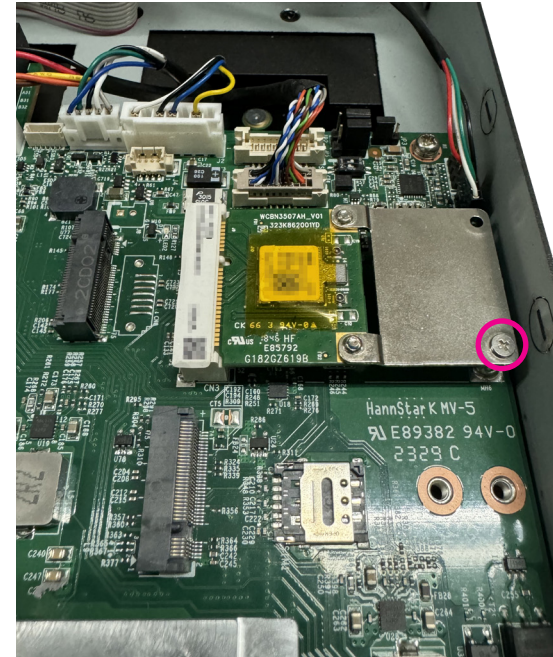

Installing a Wireless LAN Module in an M.2 Key B Slot

1. Remove the rear cover before installing the wireless LAN module, then locate the M.2 Key B slot on the motherboard.
2. This motherboard supports two M.2 Key B lengths, 2242 and 2252. Depending on the installed M.2 module length, ensure that the appropriate copper standoff (included in the accessory box) is installed on the motherboard.

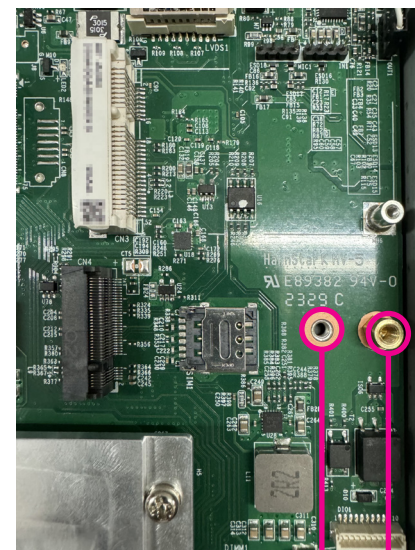
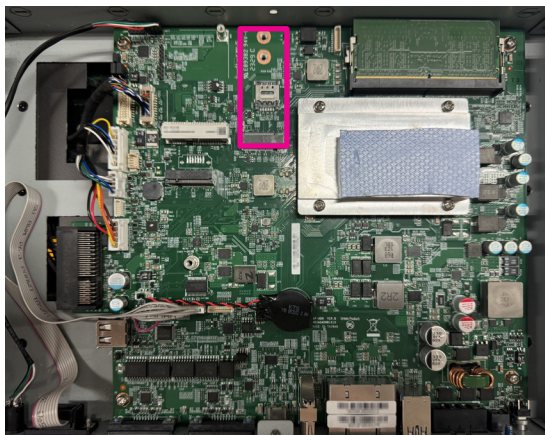

2242 2252

3. Attach the 30mm M.2 card to the adapter bracket with a screw (M2.5 x 4.5L), using the bracket and screw provided in the accessory box.



4. Insert the WLAN module into the Mini PCIe slot at a 45-degree angle until the gold-plated connector on the edge of the module is fully inserted into the slot.

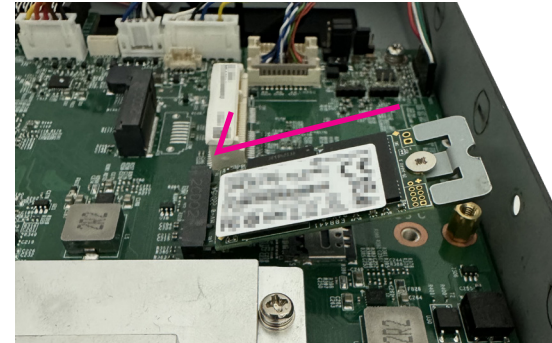

Installing a SIM Card

1. Remove the rear cover before installing the SIM card, then locate the SIM card holder on the motherboard.
2. Follow the arrow indicator to slide the SIM card cover.

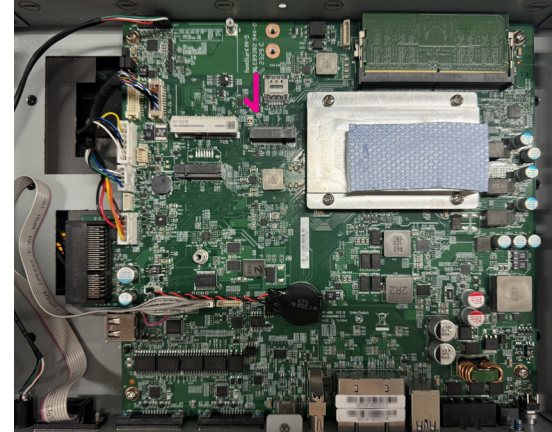
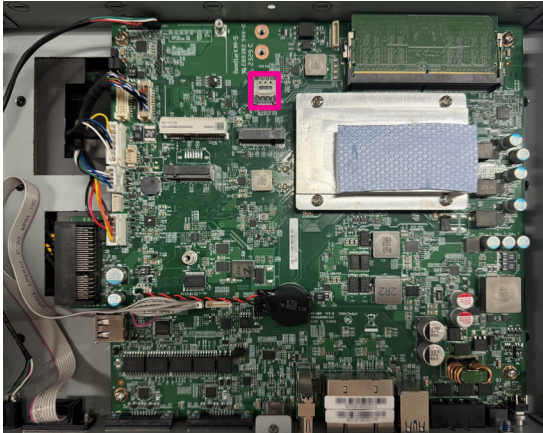

3. Lift the SIM cover.

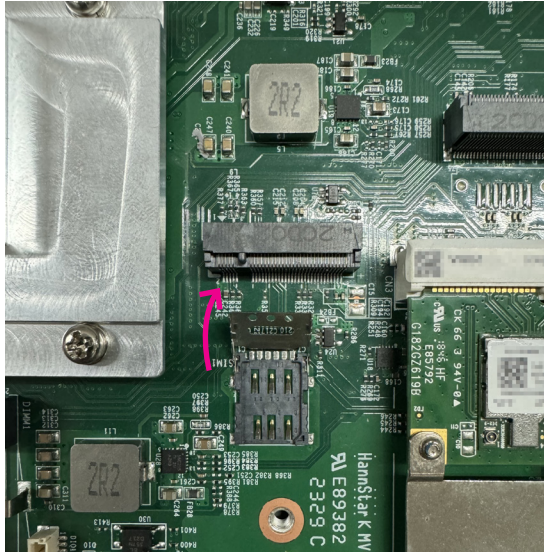

4. Insert the SIM card, matching its shape, and make sure it lies flat.



5. Cover the SIM card and slide the cover to its original location.

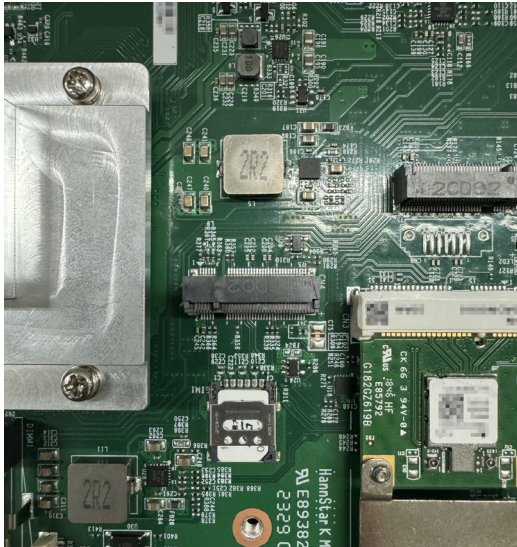

Installing an Antenna

1. Attach the RF cable to the Wi-Fi module.

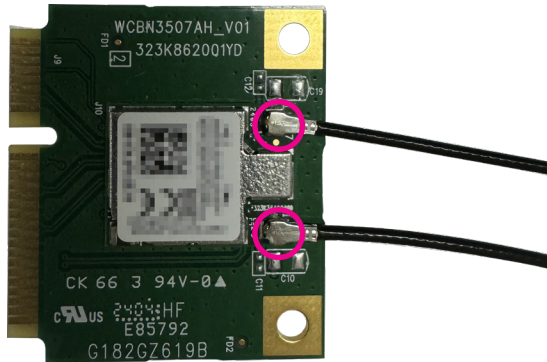

2. To open the antenna hole cover, [remove the rear cover](#) and gently push the cover from the outside of the chassis using a flathead screwdriver.

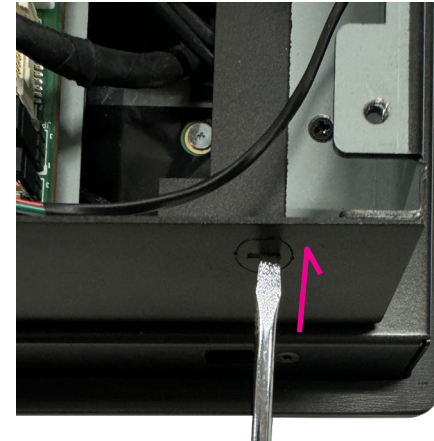

3. Insert a rubber washer onto the antenna jack, then insert the antenna jack with the washer through the antenna hole.
4. Once the previous step is complete, follow the image below to insert the other washer and gaskets. The sequence should be: rubber washer, gasket, and metal nut.
5. Connect the external antenna to the antenna jack.

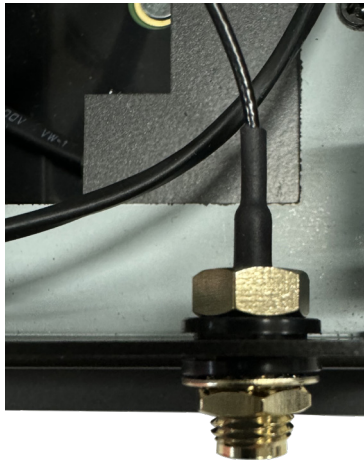

Rubber washer
Chassis
Rubber washer
Gasket
Metal nut



6. Repeat the steps above to install the other antennas.

Panel Mounting

1. Select a location on a flat panel where you will mount the panel PC.
2. Cut out a shape on the flat panel that corresponds to the panel PC's rear dimensions.
3. The thickness of the flat panel (e.g., steel board, plank, acrylic board, wall, etc.) where you will mount the panel PC must not exceed 6.5 mm for APPC 1260T and 3mm for APPC1560/1760/1960. If the distance between the front bezel and the panel mount hole is too wide, the panel mount kit will not fit.

APPC 1260T-A01

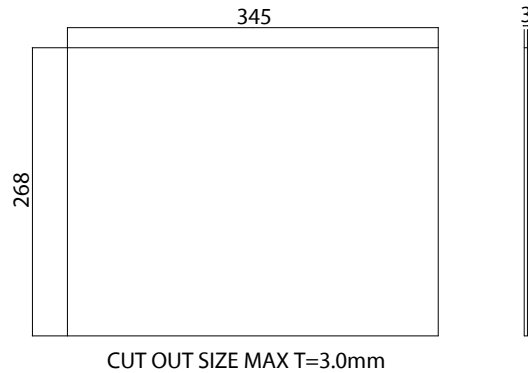
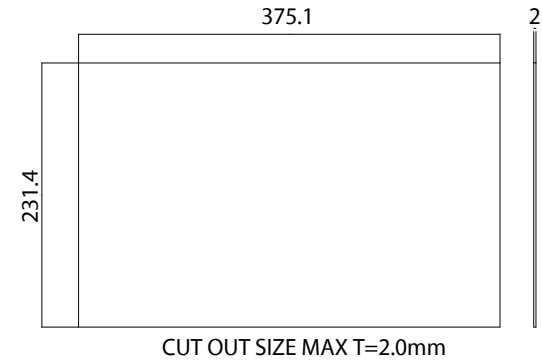

The Torque value for APPC 1260T-A01 is 5.8~6.5 kg-cm. Note that the wall mount bracket of this model is not compatible with the APPC xx60-A01 series.

APPC 1560T-A01**APPC 1660T-A01**

The Torque value for APPC 1560-A01/1660-A01/1760-A01/1960-A01/2160-A01 is 5.0~5.5kg-cm. Note that the wall mount bracket for the models mentioned above is not compatible with the APPC 1260T.

APPC 1760T-A01

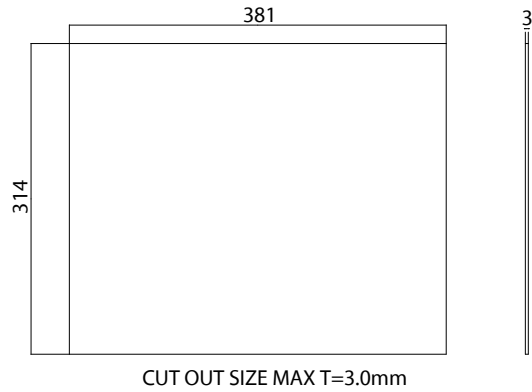

APPC 1960T-A01

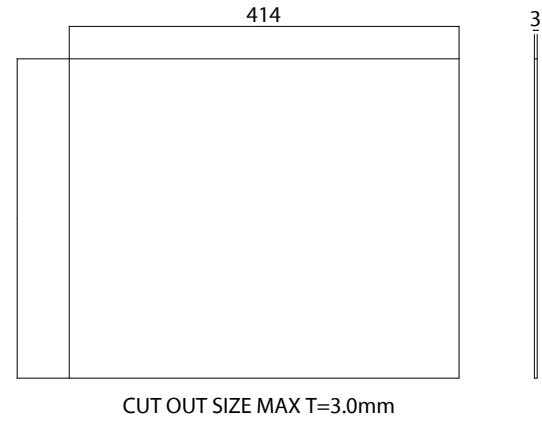

APPC 2160T-A01

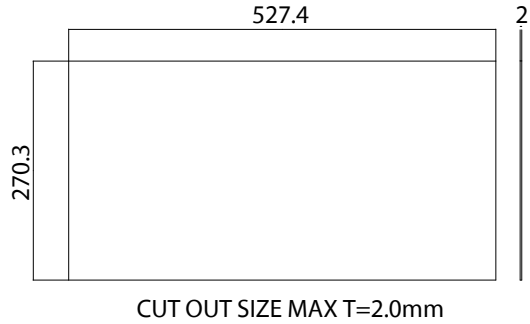

4. Follow the image below to insert the wall mount bracket into the bezel hole (wall mount bracket is provided in the accessory box).
5. Secure the screw of the wall mount bracket, and repeat the same step to secure the other wall mount brackets.

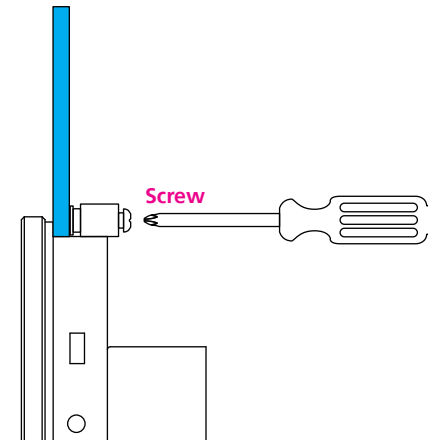
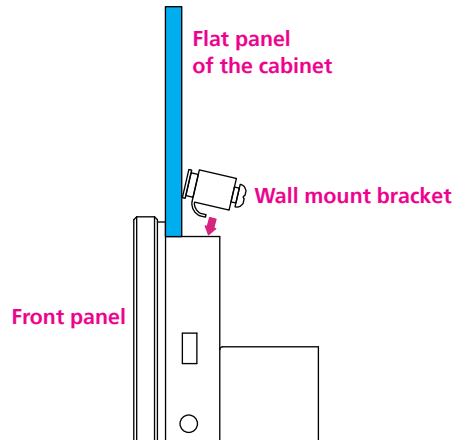

- Once the installation of the wall mount brackets is complete, it should look like the image below.

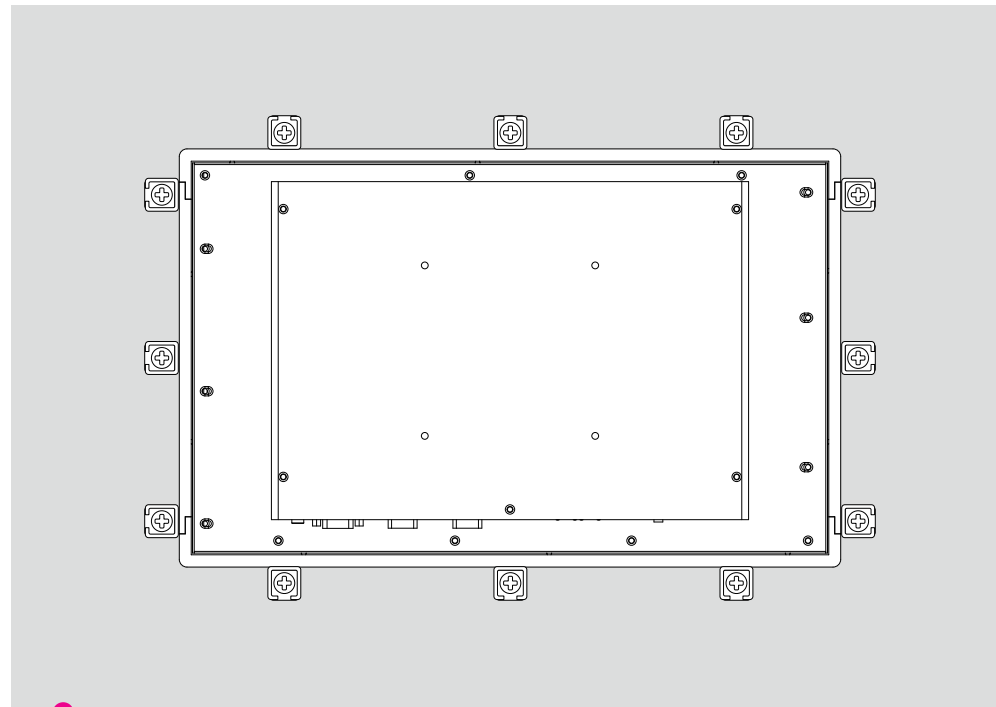

Flat panel of the cabinet

CHAPTER 4: BIOS SETUP

This chapter describes how to use the BIOS setup program for APPC 1260T-A01 and APPC xx60-A01 series. The BIOS screens provided in this chapter are for reference only and may change if the BIOS is updated in the future.

To check for the latest updates and revisions, visit the NexAIoT website at www.nexaiot.com.

About BIOS Setup

The BIOS (Basic Input and Output System) Setup program is a menu driven utility that enables you to make changes to the system configuration and tailor your system to suit your individual work needs. It is a ROM-based configuration utility that displays the system's configuration status and provides you with a tool to set system parameters.

These parameters are stored in non-volatile battery-backed-up CMOS RAM that saves this information even when the power is turned off. When the system is turned back on, the system is configured with the values found in CMOS.

With easy-to-use pull down menus, you can configure items such as:

- Hard drives, diskette drives, and peripherals
- Video display type and display options
- Password protection from unauthorized use
- Power management features

The settings made in the setup program affect how the computer performs.

It is important, therefore, first to try to understand all the setup options, and second, to make settings appropriate for the way you use the computer.

When to Configure the BIOS

- This program should be executed under the following conditions:
 - When changing the system configuration
 - When a configuration error is detected by the system and you are prompted to make changes to the setup program
 - When resetting the system clock
 - When redefining the communication ports to prevent any conflicts
 - When making changes to the Power Management configuration
 - When changing the password or making other changes to the security setup

Normally, CMOS setup is needed when the system hardware is not consistent with the information contained in the CMOS RAM, whenever the CMOS RAM has lost power, or the system features need to be changed.

Default Configuration

Most of the configuration settings are either predefined according to the Load Optimal Defaults settings which are stored in the BIOS or are automatically detected and configured without requiring any actions. There are a few settings that you may need to change depending on your system configuration.

Entering Setup











When the system is powered on, the BIOS will enter the Power-On Self Test (POST) routines. These routines perform various diagnostic checks; if an error is encountered, the error will be reported in one of two different ways:

- If the error occurs before the display device is initialized, a series of beeps will be transmitted.
- If the error occurs after the display device is initialized, the screen will display the error message.

Powering on the computer and immediately pressing allows you to enter Setup.

Press the  key to enter Setup:

Legends

Key	Function
	Moves the highlight left or right to select a menu.
	Moves the highlight up or down between sub-menus or fields.
	Exits the BIOS Setup Utility.
	Scrolls forward through the values or options of the highlighted field.
	Scrolls backward through the values or options of the highlighted field.
	Selects a field.
	Displays General Help.
	Load previous values.
	Load optimized default values.
	Saves and exits the Setup program.
	Press <Enter> to enter the highlighted sub-menu

Scroll Bar

When a scroll bar appears to the right of the setup screen, it indicates that there are more available fields not shown on the screen. Use the up and down arrow keys to scroll through all the available fields.

Submenu

When “▶” appears on the left of a particular field, it indicates that a submenu which contains additional options are available for that field. To display the submenu, move the highlight to that field and press  .

BIOS Setup Utility

Once you enter the AMI BIOS Setup Utility, the Main Menu will appear on the screen. The main menu allows you to select from several setup functions and one exit. Use arrow keys to select among the items and press  to accept or enter the submenu.

Main

The Main menu is the first screen that you will see when you enter the BIOS Setup Utility.

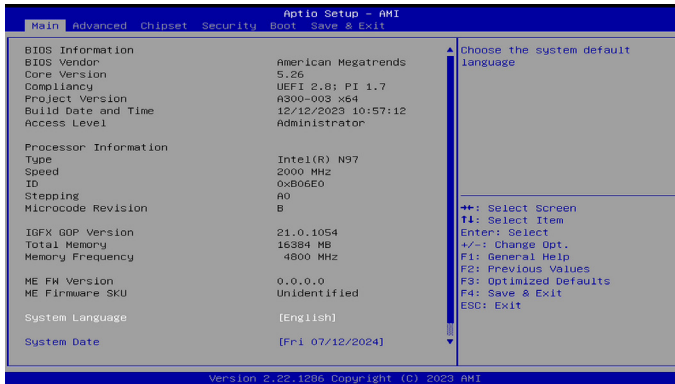

System Date

The date format is <day>, <month>, <date>, <year>. Day displays a day, from Monday to Sunday. Month displays the month, from January to December. Date displays the date, from 1 to 31. Year displays the year, from 2005 to 2099.

System Time

The time format is <hour>, <minute>, <second>. The time is based on the 24-hour military-time clock. For example, 1 p.m. is 13:00:00. Hour displays hours from 00 to 23. Minute displays minutes from 00 to 59. Second displays seconds from 00 to 59.

Advanced

The Advanced menu allows you to configure your system for basic operation. Some entries are defaults required by the system board, while others, if enabled, will improve the performance of your system or let you set some features according to your preference.



Setting incorrect field values may cause the system to malfunction.

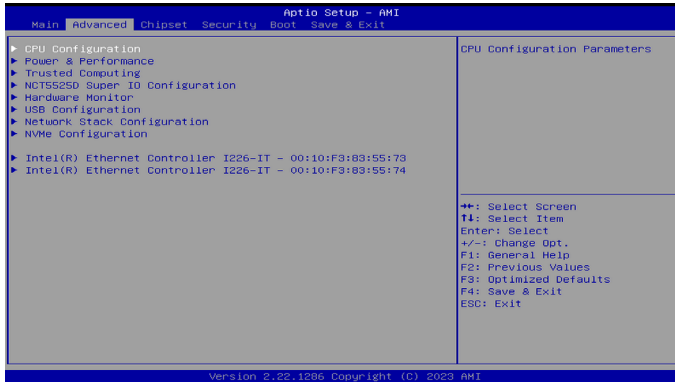

CPU Configuration

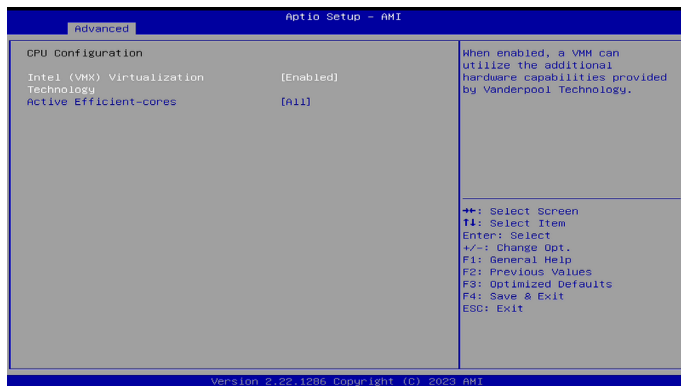

Intel (VMX) Virtualization

When enabled, a VMM can utilize the additional hardware capabilities provides by Venderpool technology.

Active Efficient-cores

Number of E-cores to enable in each processor package. Note: Number of Cores and E-cores are looked at together. When both are [0,0] Pcode will enable all cores.

Power & Performance

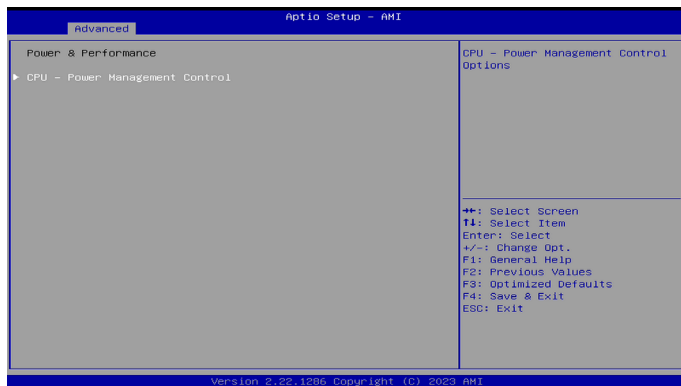

CPU - Power Management Control

Enter the CPU - Power Management Control submenu.

CPU - Power Management Control

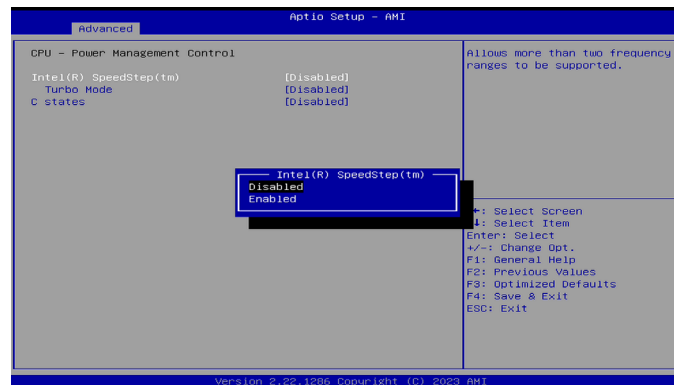

Intel(R) SpeedStep(tm)

Allow more than two frequency ranges to be supported.

Turbo Mode

Enable or disable processor Turbo Mode (requires EMTTM enabled too). Auto means enabled.

C states

Enable or disable CPU Power Management. Allow CPU to go to C states when it's not 100% utilized.

Trusted Computing

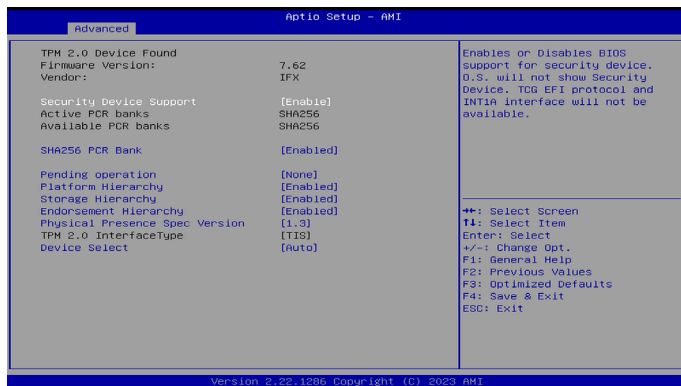

Security Device Support

Enable or disable BIOS support for security device. O.S will not show Security Device. TCG EFI protocol and INT1A interface will not be available.

SHA256 PCR Bank

Enable or disable SHA256 PCR Bank.

Pending operation

Schedule an operation for the security device. Note: Your computer will reboot during restart in order to change state of Security Device.

Platform Hierarchy

Enable or disable platform hierarchy.

Storage Hierarchy

Enable or disable storage hierarchy.

Endorsement Hierarchy

Enable or disable endorsement hierarchy.

TPM2.0 UEFI Spec Version

Configure the TPM2.0 UEFI spec version.

Physical Presence Spec Version

Configure the physical presence spec version.

Device Select

TPM 1.2 will restrict support to TPM 1.2 devices. TPM 2.0 will restrict support to TPM 2.0 devices. Auto will support both TPM 1.2 and 2.0 devices with the default set to TPM 2.0 devices if not found, and TPM 1.2 devices will be enumerated.

NCT5525D Super IO Configuration

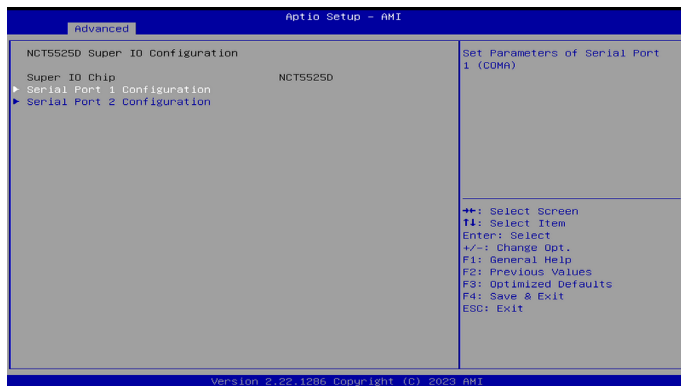

Serial Port 1/2 Configuration

Enter the Serial Port 1/2 Configuration submenu.

Serial Port 1/2 Configuration

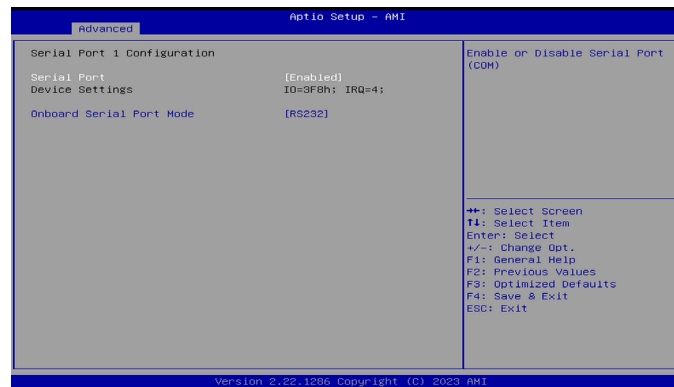

Serial Port (Port1/2)

Enable or disable the serial port.

Onboard Series Port Mode (Port1/2)

Change the series port mode.

Hardware Monitor

This section is used to monitor hardware status such as temperature and voltages.

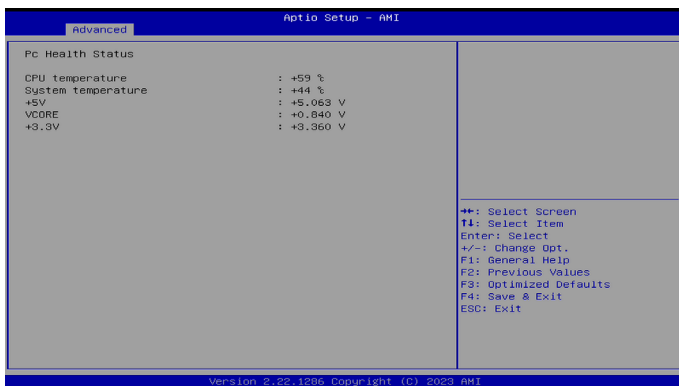

USB Configuration

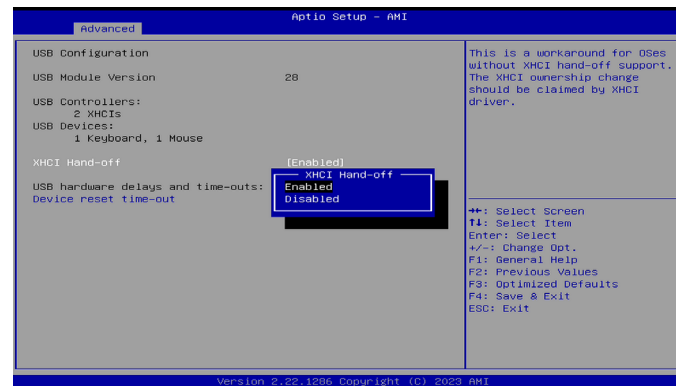

XHCI Hand-off

This is a workaround for OSe without XHCI hand-off support. The XHCI ownership change should be claimed by the XHCI driver.

Device reset time-out

Select mass storage device start unit command time-out.

Network Stack Configuration

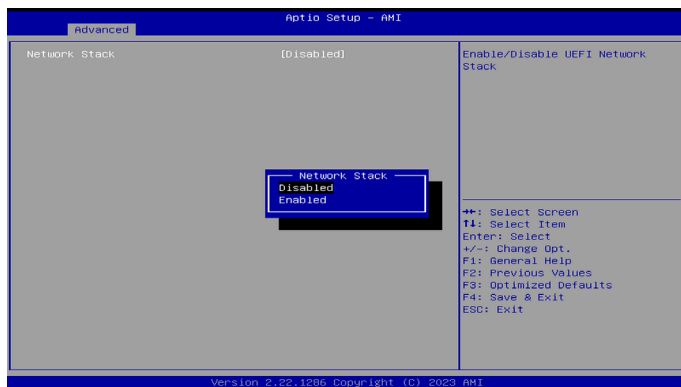

Network Stack

Enable or disable UEFI Network Stack.

NVMe Configuration

This section is used to configure the NVMe devices installed. The options will become available upon installation of the NVMe device.

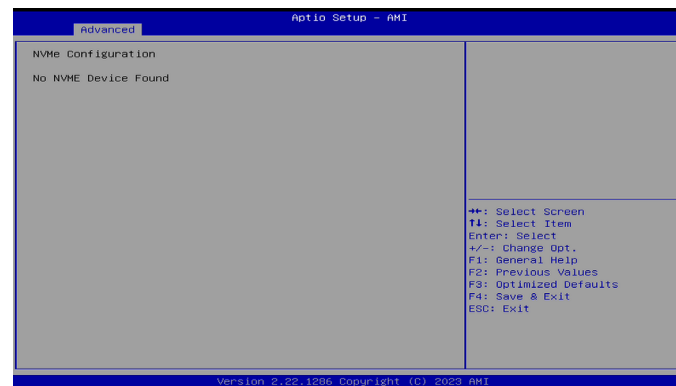

Intel(R) Ethernet Controller

This section is used to monitor the built-in Ethernet controller.

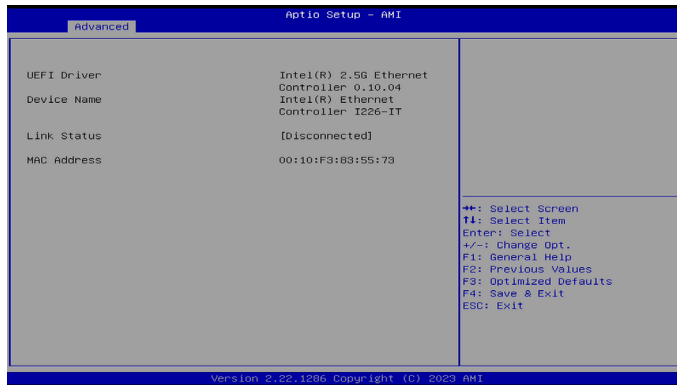

Chipset

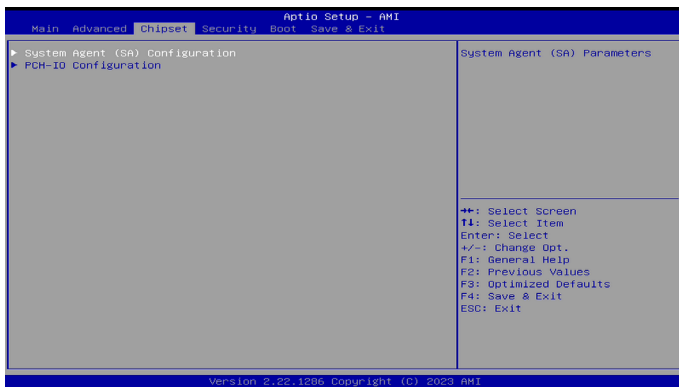

System Agent (SA) Configuration

Enter the System Agent Configuration submenu.

PCH-IO Configuration

Enter the PCH-IO Configuration submenu.

System Agent (SA) Configuration



Graphics Configuration

Enter the Graphics Configuration submenu.

VT-d

Enable or disable VT-d capability.

Graphics Configuration

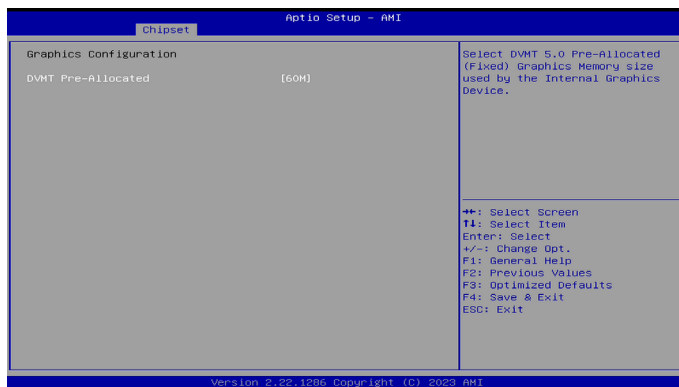

DVMT Pre-Allocated

Select DVMT 5.0 pre-allocated (fixed) graphics memory size used by the Internal graphics device.

PCH-IO Configuration

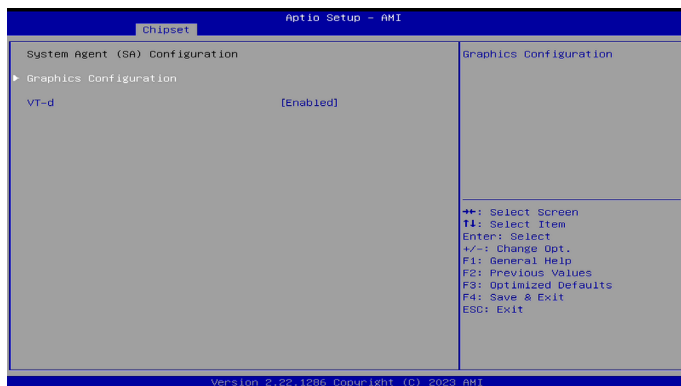

SATA Configuration



SATA Configuration

Enter the SATA Configuration submenu.

Security Configuration

Enter the Security Configuration submenu.

Seriallo Configuration

Enter the Seriallo Configuration submenu.

State After G3

Specify what state to go to when power is re-applied after a power failure (G3 state)

USB Power State in Standby

Select USB power state in standby.

SATA Controller(s)

Enable or disable SATA device.

RTC Memory Lock

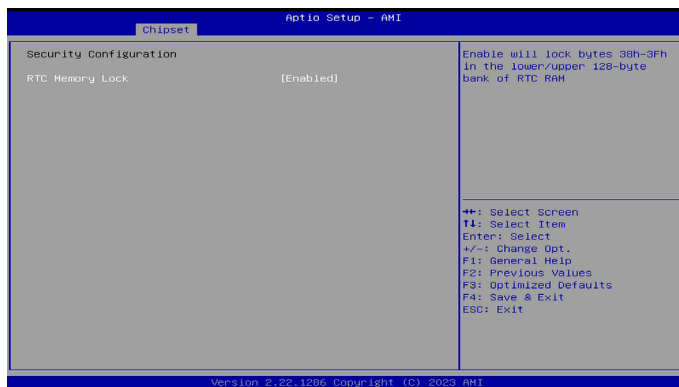

RTC Memory Lock

Enable will lock bytes 38h-3Fh in the lower/upper 128-byte bank of RTC RAM.

Seriallo Configuration

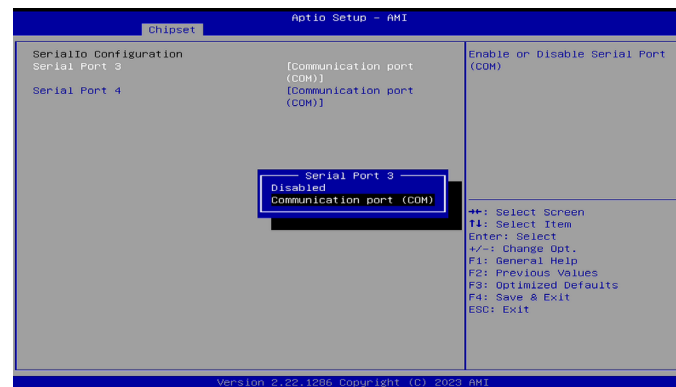

Serial 3/4

Enable or disable serial port (COM).

Security

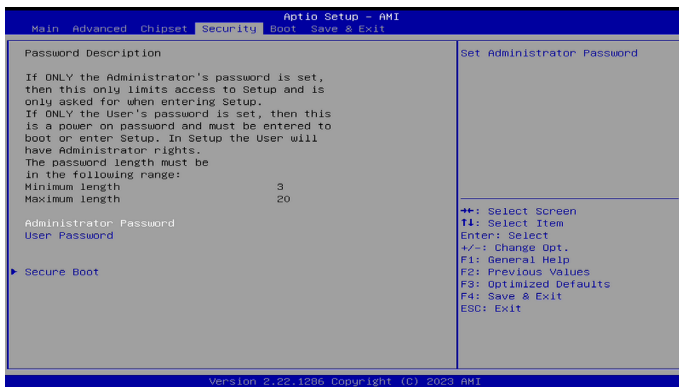

Administrator Password

Select this to reconfigure the administrator's password.

User Password

Select this to reconfigure the user's password.

Secure Boot

Enter the Secure Boot submenu.

Secure Boot



Secure Boot

Enable or disable Secure Boot. Secure Boot only works when the system is running in user mode and requires a platform reset.

Secure Boot Mode

Standard: Fixed secure boot policy.

Custom: Secure boot policy variables can be configured by a physically present user without full authentication.

Restore Factory Keys

Allow you to install factory default secure boot key databases.

Reset to Setup Mode

Delete all Secure Boot Key databases from NVRAM.

Key Management

Enable experienced users to modify Secure Boot variables.

Boot

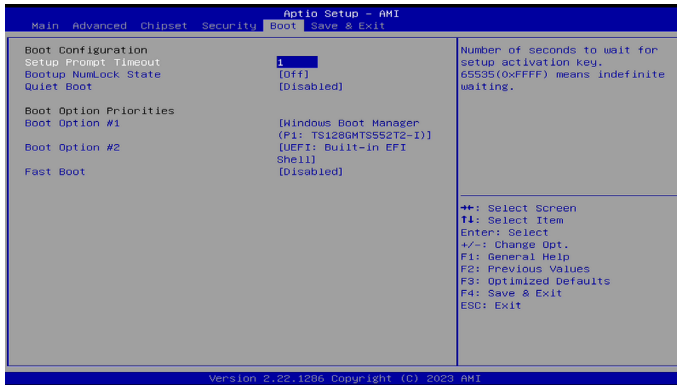

Setup Prompt Timeout

Number of seconds to wait for setup activation key. 65535(0xFFFF) means indefinite waiting.

Bootup NumLock State

Select the keyboard numlock state.

Quiet Boot

Enable or disable quiet boot option.

Boot Option

Adjust the boot sequence of the system. Boot Option #1 is the first boot device that the system will boot from, next will be #2 and so forth.

Fast Option

When enabled, the BIOS will shorten or skip some check items during POST. This will decrease the time needed to boot the system.

Save & Exit

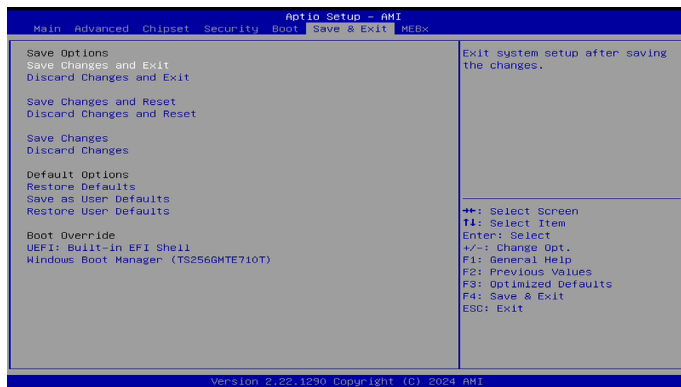

Save Changes and Exit

To save the changes and reset, select this field then press <Enter>. A dialog box will appear. Confirm by selecting Yes.

Discard Changes and Exit

To exit the Setup utility without saving the changes, select this field then press <Enter>. You may be prompted to confirm again before exiting. You can also press <ESC> to exit without saving the changes.

Save Changes and Reset

To save the changes and reset, select this field then press <Enter>. A dialog box will appear. Confirm by selecting Yes

Discard Changes and Reset

To exit the Setup utility and reset without saving the changes, select this field then press <Enter>. You may be prompted to confirm again before exiting.

Save Changes

To save changes and continue configuring the BIOS, select this field then press <Enter>. A dialog box will appear. Confirm by selecting Yes.

Discard Changes

To discard the changes, select this field then press <Enter>. A dialog box will appear. Confirm by selecting Yes to discard all changes made and restore the previously saved settings.

Restore Defaults

To restore the BIOS to default settings, select this field then press <Enter>. A dialog box will appear. Confirm by selecting Yes.

Save as User Defaults

To use the current configurations as user default settings for the BIOS, select this field then press <Enter>. A dialog box will appear. Confirm by selecting Yes.

Restore User Defaults

To restore the BIOS to user default settings, select this field then press <Enter>. A dialog box will appear. Confirm by selecting Yes, then press <Enter>. You may be prompted to confirm again before exiting.

Boot Override

To bypass the boot sequence from the Boot Option List and boot from a particular device, select the desired device and press <Enter>.

APPENDIX A: POWER CONSUMPTION

Test Equipment/Software

Item	Description
Main Board	20IA00ADN00X0-AP-ADN
CPU	Intel® Processor N97, Quad Core 2.0GHz, 6M Cache
RAM	Transcend 16GB DDR5 16GB DDR5 4800 SO-DIMM 1Rx8 2Gx8 CL40 1.1V, SAMSUNG-1Y, 0~95°C
M.2	Innodisk M.2(S42) 3TE7
M.2 3052	Quectel RM500Q-GL
BIOS Ver.	A300T006
mPCIe	博飛-ML225IT Mini PCIe to LAN
PCIe	INTEL GIGABIT CT DESKTOP EXP1930 (LAN controller Intel® 82574L)
Power Supply	FSP060-DAAN2 24V-2.5A
Operation System	Windows 10

Power consumption

Model	Voltage	Max Load current (A)	Standby current (A)	Sleep current (A)
APPC1260T-A01	24V	1.605A	0.911A	0.194A
APPC1560-A01		1.736A	0.905A	0.172A
APPC1760-A01		1.840A	0.999A	0.174A
APPC1960-A01		1.719A	1.472A	0.772A
APPC1660-A01		1.934A	1.059A	0.166A
APPC2160-A01		2.236A	1.321A	0.169A