

NEXCOM International Co., Ltd.

**Mobile Computing Solutions**  
**Fanless Railway Computer**  
**nROK 3000**  
User Manual

# Contents

## Preface

Copyright .....	iv
Disclaimer .....	iv
Acknowledgements .....	iv
Regulatory Compliance Statements .....	iv
Declaration of Conformity.....	iv
RoHS Compliance .....	v
Warranty and RMA .....	vi
Safety Information .....	vii
Installation Recommendations.....	vii
Safety Precautions.....	viii
Technical Support and Assistance.....	ix
Conventions Used in this Manual.....	ix
Global Service Contact Information.....	x
Package Contents.....	xii
Ordering Information .....	xiii

## Chapter 1: Product Introduction

Overview .....	1
Key Features.....	1
Hardware Specifications.....	3
Getting to Know nROK 3000.....	4
Front Panel.....	4
Rear Panel.....	9

## Chapter 2: Jumpers and Connectors

Before You Begin .....	11
Precautions .....	11
Jumper .....	12
Locations of the Jumpers and Connectors.....	13
Jumper Settings .....	14
IGNITION Select (JP7) .....	14
IGNITION Select ( JP8) (default NC).....	14
CMOS Input Voltage Select (J3).....	14
TEMP SENSOR (JP5) .....	14
PCI104 V/I/O Select Voltage (J9 ) .....	14
MCU Download (JP4) .....	14
GAL Download (JP2).....	14
MCU COM PORT (JP6).....	14
Connectors.....	15
UART CONNECTOR (RS232/422/485&GPIO) (CN1) .....	15
DVI+VGA CONNECTOR (CN2) .....	15
GPS Connector COM6 (J4) .....	16
AUDIO CONNECTOR (J11) .....	16
GAL Programmer PIN Header (JP2).....	17
MCU Programmer PIN Header (JP4) .....	17
LAN connector (J5)(J7)(J8).....	18
FRONT USB connector (J10) .....	18
REAR USB connector (USB1) .....	19
PCI-104 V/I/O voltage setting (J9).....	19

PCI-104 connector (CN21).....	20
RESET BUTTON (SW2) .....	21
MCU COM PORT (JP6).....	21
TEMP SENSOR (JP5) .....	22
POWER INPUT .....	22
+12V DC Power Input Connector (CON1).....	22
12VSD DC Power Input Connector (CON2) .....	23
12VSD GPIO (J6).....	23
POWER ON ,HD ,WWAN ,WLAN Active LED (LED1).....	24
Serial-ATA (CN3).....	24
Serial-ATA POWER INPUT (J1).....	25
Mini-PCIe (3.5G)(CN6).....	25
Mini-PCIe (WLAN)(CN7).....	26
SIM CARD CONNECTOR (CN4) (CN5) .....	26

### Chapter 3: System Setup

Removing the Chassis Cover .....	27
Installing the Wi-Fi and GPRS/UMTS/HSDPA Modules .....	29
Installing SSD Drive .....	30
Rackmount Brackets .....	32

### Appendix A: I/O Address Function

I/O Address Function.....	33
---------------------------	----

### Appendix B: Power Consumption

Power Consumption .....	37
-------------------------	----

# Preface

## Copyright

This publication, including all photographs, illustrations and software, is protected under international copyright laws, with all rights reserved. No part of this manual may be reproduced, copied, translated or transmitted in any form or by any means without the prior written consent from NEXCOM International Co., Ltd.

## Disclaimer

The information in this document is subject to change without prior notice and does not represent commitment from NEXCOM International Co., Ltd. However, users may update their knowledge of any product in use by constantly checking its manual posted on our website: <http://www.nexcom.com>. NEXCOM shall not be liable for direct, indirect, special, incidental, or consequential damages arising out of the use of any product, nor for any infringements upon the rights of third parties, which may result from such use. Any implied warranties of merchantability or fitness for any particular purpose is also disclaimed.

## Acknowledgements

nROK 3000 is a trademark of NEXCOM International Co., Ltd. All other product names mentioned herein are registered trademarks of their respective owners.

## Regulatory Compliance Statements

This section provides the FCC compliance statement for Class A devices and describes how to keep the system CE compliant.

## Declaration of Conformity

### FCC

This equipment has been tested and verified to comply with the limits for a Class A digital device, pursuant to Part 15 of FCC Rules. These limits are designed to provide reasonable protection against harmful interference when the equipment is operated in a commercial environment. This equipment generates, uses, and can radiate radio frequency energy and, if not installed and used in accordance with the instructions, may cause harmful interference to radio communications. Operation of this equipment in a residential area (domestic environment) is likely to cause harmful interference, in which case the user will be required to correct the interference (take adequate measures) at their own expense.

### CE

The product(s) described in this manual complies with all applicable European Union (CE) directives if it has a CE marking. For computer systems to remain CE compliant, only CE-compliant parts may be used. Maintaining CE compliance also requires proper cable and cabling techniques.

## RoHS Compliance

### NEXCOM RoHS Environmental Policy and Status Update



NEXCOM is a global citizen for building the digital infrastructure. We are committed to providing green products and services, which are compliant with European Union RoHS (Restriction on Use of Hazardous Substance in Electronic Equipment) directive 2002/95/EU, to be your trusted green partner and to protect our environment.

RoHS restricts the use of Lead (Pb) < 0.1% or 1,000ppm, Mercury (Hg) < 0.1% or 1,000ppm, Cadmium (Cd) < 0.01% or 100ppm, Hexavalent Chromium (Cr6+) < 0.1% or 1,000ppm, Polybrominated biphenyls (PBB) < 0.1% or 1,000ppm, and Polybrominated diphenyl Ethers (PBDE) < 0.1% or 1,000ppm.

In order to meet the RoHS compliant directives, NEXCOM has established an engineering and manufacturing task force in to implement the introduction of green products. The task force will ensure that we follow the standard NEXCOM development procedure and that all the new RoHS components and new manufacturing processes maintain the highest industry quality levels for which NEXCOM are renowned.

The model selection criteria will be based on market demand. Vendors and suppliers will ensure that all designed components will be RoHS compliant.

### How to recognize NEXCOM RoHS Products?

For existing products where there are non-RoHS and RoHS versions, the suffix "(LF)" will be added to the compliant product name.

All new product models launched after January 2006 will be RoHS compliant. They will use the usual NEXCOM naming convention.

## Warranty and RMA

### NEXCOM Warranty Period

NEXCOM manufactures products that are new or equivalent to new in accordance with industry standard. NEXCOM warrants that products will be free from defect in material and workmanship for 2 years, beginning on the date of invoice by NEXCOM. HCP series products (Blade Server) which are manufactured by NEXCOM are covered by a three year warranty period.

### NEXCOM Return Merchandise Authorization (RMA)

- ✘ Customers shall enclose the “NEXCOM RMA Service Form” with the returned packages.
- ✘ Customers must collect all the information about the problems encountered and note anything abnormal or, print out any on-screen messages, and describe the problems on the “NEXCOM RMA Service Form” for the RMA number apply process.
- ✘ Customers can send back the faulty products with or without accessories (manuals, cable, etc.) and any components from the card, such as CPU and RAM. If the components were suspected as part of the problems, please note clearly which components are included. Otherwise, NEXCOM is not responsible for the devices/parts.
- ✘ Customers are responsible for the safe packaging of defective products, making sure it is durable enough to be resistant against further damage and deterioration during transportation. In case of damages occurred during transportation, the repair is treated as “Out of Warranty.”
- ✘ Any products returned by NEXCOM to other locations besides the customers’ site will bear an extra charge and will be billed to the customer.

### Repair Service Charges for Out-of-Warranty Products

NEXCOM will charge for out-of-warranty products in two categories, one is basic diagnostic fee and another is component (product) fee.

#### System Level

- ✘ Component fee: NEXCOM will only charge for main components such as SMD chip, BGA chip, etc. Passive components will be repaired for free, ex: resistor, capacitor.
- ✘ Items will be replaced with NEXCOM products if the original one cannot be repaired. Ex: motherboard, power supply, etc.
- ✘ Replace with 3<sup>rd</sup> party products if needed.
- ✘ If RMA goods can not be repaired, NEXCOM will return it to the customer without any charge.

## Board Level

- ✘ Component fee: NEXCOM will only charge for main components, such as SMD chip, BGA chip, etc. Passive components will be repaired for free, ex: resistors, capacitors.

If RMA goods can not be repaired, NEXCOM will return it to the customer without any charge.

## Warnings

Read and adhere to all warnings, cautions, and notices in this guide and the documentation supplied with the chassis, power supply, and accessory modules. If the instructions for the chassis and power supply are inconsistent with these instructions or the instructions for accessory modules, contact the supplier to find out how you can ensure that your computer meets safety and regulatory requirements.

## Cautions

Electrostatic discharge (ESD) can damage system components. Do the described procedures only at an ESD workstation. If no such station is available, you can provide some ESD protection by wearing an antistatic wrist strap and attaching it to a metal part of the computer chassis.

## Safety Information

Before installing and using the device, note the following precautions:

- ✘ Read all instructions carefully.
- ✘ Do not place the unit on an unstable surface, cart, or stand.
- ✘ Follow all warnings and cautions in this manual.

- When replacing parts, ensure that your service technician uses parts specified by the manufacturer.
- Avoid using the system near water, in direct sunlight, or near a heating device.
- The load of the system unit does not solely rely for support from the rackmounts located on the sides. Firm support from the bottom is highly necessary in order to provide balance stability.

The computer is provided with a battery-powered real-time clock circuit. There is a danger of explosion if battery is incorrectly replaced. Replace only with the same or equivalent type recommended by the manufacturer. Discard used batteries according to the manufacturer's instructions.

## Installation Recommendations

Ensure you have a stable, clean working environment. Dust and dirt can get into components and cause a malfunction. Use containers to keep small components separated.

Adequate lighting and proper tools can prevent you from accidentally damaging the internal components. Most of the procedures that follow require only a few simple tools, including the following:

- A Philips screwdriver
- A flat-tipped screwdriver
- A grounding strap
- An anti-static pad

Using your fingers can disconnect most of the connections. It is recommended that you do not use needlenose pliers to disconnect connections as these can damage the soft metal or plastic parts of the connectors.

## Safety Precautions

1. Read these safety instructions carefully.
2. Keep this User Manual for later reference.
3. Disconnect this equipment from any AC outlet before cleaning. Use a damp cloth. Do not use liquid or spray detergents for cleaning.
4. For plug-in equipment, the power outlet socket must be located near the equipment and must be easily accessible.
5. Keep this equipment away from humidity.
6. Put this equipment on a stable surface during installation. Dropping it or letting it fall may cause damage.
7. Do not leave this equipment in either an unconditioned environment or in a above 40°C storage temperature as this may damage the equipment.
8. The openings on the enclosure are for air convection to protect the equipment from overheating. **DO NOT COVER THE OPENINGS.**
9. Make sure the voltage of the power source is correct before connecting the equipment to the power outlet.
10. Place the power cord in a way so that people will not step on it. Do not place anything on top of the power cord. Use a power cord that has been approved for use with the product and that it matches the voltage and current marked on the product's electrical range label. The voltage and current rating of the cord must be greater than the voltage and current rating marked on the product.
11. All cautions and warnings on the equipment should be noted.
12. If the equipment is not used for a long time, disconnect it from the power source to avoid damage by transient overvoltage.
13. Never pour any liquid into an opening. This may cause fire or electrical shock.
14. Never open the equipment. For safety reasons, the equipment should be opened only by qualified service personnel.
15. If one of the following situations arises, get the equipment checked by service personnel:
  - a. The power cord or plug is damaged.
  - b. Liquid has penetrated into the equipment.
  - c. The equipment has been exposed to moisture.
  - d. The equipment does not work well, or you cannot get it to work according to the user's manual.
  - e. The equipment has been dropped and damaged.
  - f. The equipment has obvious signs of breakage.
16. Do not place heavy objects on the equipment.
17. The unit uses a three-wire ground cable which is equipped with a third pin to ground the unit and prevent electric shock. Do not defeat the purpose of this pin. If your outlet does not support this kind of plug, contact your electrician to replace your obsolete outlet.
18. **CAUTION:** DANGER OF EXPLOSION IF BATTERY IS INCORRECTLY REPLACED. REPLACE ONLY WITH THE SAME OR EQUIVALENT TYPE RECOMMENDED BY THE MANUFACTURER. DISCARD USED BATTERIES ACCORDING TO THE MANUFACTURER'S INSTRUCTIONS.
19. The computer is provided with CD drives that comply with the appropriate safety standards including IEC 60825.



## Technical Support and Assistance

1. For the most updated information of NEXCOM products, visit NEXCOM's website at [www.nexcom.com](http://www.nexcom.com).
2. For technical issues that require contacting our technical support team or sales representative, please have the following information ready before calling:
  - Product name and serial number
  - Detailed information of the peripheral devices
  - Detailed information of the installed software (operating system, version, application software, etc.)
  - A complete description of the problem
  - The exact wordings of the error messages

### Warning!

1. Handling the unit: carry the unit with both hands and handle it with care.
2. Maintenance: to keep the unit clean, use only approved cleaning products or clean with a dry cloth.
3. CompactFlash: Turn off the unit's power before inserting or removing a CompactFlash storage card.

## Conventions Used in this Manual



**Warning:** Information about certain situations, which if not observed, can cause personal injury. This will prevent injury to yourself when performing a task.



**Caution:** Information to avoid damaging components or losing data.



**Note:** Provides additional information to complete a task easily.

## Battery - Safety Measures

### Caution

- Risk of explosion if battery is replaced by an incorrect type.
- Dispose of used batteries according to the instructions.

### Safety Warning



This equipment is intended for installation in a Restricted Access Location only.

## Resetting the Date and Time



**Note:** Remember to reset the date and time upon receiving the product. You can set them in the AMI BIOS. Refer to chapter 4 for more information.

## Global Service Contact Information

### Headquarters

#### **NEXCOM International Co., Ltd.**

15F, No. 920, Chung-Cheng Rd.,  
ZhongHe District, New Taipei City, 23586,  
Taiwan, R.O.C.

Tel: +886-2-8226-7786

Fax: +886-2-8226-7782

[www.nexcom.com](http://www.nexcom.com)

### America

#### **USA**

#### **NEXCOM USA**

2883 Bayview Drive,  
Fremont CA 94538, USA

Tel: +1-510-656-2248

Fax: +1-510-656-2158

Email: [sales@nexcom.com](mailto:sales@nexcom.com)

[www.nexcom.com](http://www.nexcom.com)

### Asia

#### **Taiwan**

#### **Central Taiwan Office**

16F, No.250, Sec. 2, Chongde Rd.,  
Beitun Dist., Taichung City 406, R.O.C.

Tel: +886-4-2249-1179

Fax: +886-4-2249-1172

Email: [sales@nexcom.com.tw](mailto:sales@nexcom.com.tw)

[www.nexcom.com.tw](http://www.nexcom.com.tw)

### Japan

#### **NEXCOM Japan**

9F, Tamachi Hara Bldg., 4-11-5, Shiba Minato-ku,  
Tokyo, 108-0014, Japan

Tel: +81-3-5419-7830

Fax: +81-3-5419-7832

Email: [sales@nexcom-jp.com](mailto:sales@nexcom-jp.com)

[www.nexcom-jp.com](http://www.nexcom-jp.com)

### China

#### **NEXCOM China**

2F, Block 4, Venus Plaza, Bldg. 21,  
ZhongGuanCun Software Park, No. 8,  
Dongbeiwang West Rd., Haidian District,  
Beijing, 100193, China

Tel: +86-10-8282-6599

Fax: +86-10-8282-5955

Email: [sales@nexcom.cn](mailto:sales@nexcom.cn)

[www.nexcom.cn](http://www.nexcom.cn)

### Shanghai Office

Room 603/604, Huiyinmingzun Plaza Bldg., 1,  
No.609, Yunlin East Rd.,  
Shanghai, 200062, China

Tel: +86-21-5278-5868

Fax: +86-21-3251-6358

Email: [sales@nexcom.cn](mailto:sales@nexcom.cn)

[www.nexcom.cn](http://www.nexcom.cn)

## Shenzhen Office

Room1707, North Block, Pines Bldg.,  
No.7 Tairan Rd., Futian Area,  
Shenzhen, 518040, China  
Tel: +86-755-8332-7203  
Fax: +86-755-8332-7213  
Email: sales@nexcom.cn  
www.nexcom.cn

## Wuhan Office

1-C1804/ 1805, Mingze Liwan,  
No. 519 South Luoshi Rd.,  
Hongshan District,  
Wuhan, 430070, China  
Tel: +86-27-8722-7400  
Fax: +86-27-8722-7400  
Email: sales@nexcom.cn  
www.nexcom.cn

## Chengdu Office

9F, Shuxiangxie, Xuefu Garden,  
No.12 Section 1, South Yihuan Rd.,  
Chengdu, 610061, China  
Tel: +86-28-8523-0186  
Fax: +86-28-8523-0186  
Email: sales@nexcom.cn  
www.nexcom.cn

## Europe

### Italy

#### NEXCOM ITALIA S.r.l

Via Gaudenzio Ferrari 29,  
21047 Saronno (VA), Italia  
Tel: +39 02 9628 0333  
Fax: +39 02 9286 9215  
Email: nexcomitalia@nexcom.eu  
www.nexcomitalia.it

### United Kingdom

#### NEXCOM EUROPE

10 Vincent Avenue,  
Crownhill Business Centre,  
Milton Keynes, Buckinghamshire MK8 0AB,  
United Kingdom  
Tel: +44-1908-267121  
Fax: +44-1908-262042  
Email: sales.uk@nexcom.eu  
www.nexcom.eu

## Package Contents

Before continuing, verify that the package that you received is complete. Your package should have all the items listed in the following table.

Item	P/N	Name	Specification	Qty
1	50311F0110X00	FLAT HEAD SCREW	F3x5 NI NYLOK	4
2	60233SAM05X00	GPS ANTENNA	5M /SMA180P	1
3	602DCD0393X00	CD DRIVER		1

## Ordering Information

The following provides ordering information.

- **nROK 3000-A (P/N: 10A00300000X0)**
  - Intel® Atom™ D525 fanless railway computer with 24VDC isolation power input
- **nROK 3000-F (P/N: 10A00300001X0)**
  - Intel® Atom™ D525 fanless railway computer with 110VDC isolation power input
- **POWER CABLE (P/N: 60233PW243X00)**
  - Waterproof 4P L:300mm
- **M12 TO USB CABLE (P/N: 60233USB89X00)**
  - Waterproof M12 TO USB CON L:200mm
- **AUDIO CABLE (P/N: 60233AUD27X00)**
  - Waterproof MINI SIZE 6P TO DC3.5mm FEMALEx2 L:300mm
- **DVI Y-CABLE (P/N: 60233DVI26X00)**
  - Waterproof DVI(24+5P) to DVI(24+5P)/D-SUB(15P) L:100mm
- **COM CABLE (P/N: 6023331451X00)**
  - Waterproof 31PIN to DB9 MALEx4/DB9 FEMALEx1 L=150mm

# Chapter 1: Product Introduction

## Overview



Front View



Rear View

### Key Features

- Built-in Intel® Atom™ D525 Dual Core 1.8GHz processor
- Fanless and rugged design
- Availability of GPS, GPRS/ UMTS/ HSDPA
- Multiple display connections: Dual VGA and DVI-D
- PCI-104 and 2 x Mini card expansion interface
- Rich I/O interface with secure lock
- Isolation RS-232/ 422/ 485 and GPIO
- Easy maintenance
- Removable 2.5" SSD tray
- Optional 24V/110V DC input with isolated protection
- Compliant IP65 design
- Certified by EN50155

The latest transportation computing solution nROK 3000 fanless computer certified with EN50155 is specially designed for railway related applications.

Based on Intel® Atom™ D525 processor, nROK 3000 is designed with isolated DC input protection to ensure stable operation in harsh environments. Adopting lock concept, all connectors, such as M12 Ethernet connector on nROK 3000, are designed for anti-vibration.

Equipped with a SIM card holder, CFast socket and mini-PCIe socket for optional 3G wireless module, nROK 3000 allows data to be transmitted over network and stored in a convenient SSD (Solid-State Drive) or CFast card for better vibration and shock protection. The EN50155-certified nROK 3000 is a reliable solution for railway applications.

## Hardware Specifications

### Main Chipset

- Intel® ICH-8M

### CPU

- Intel® Atom™ D525 Dual Core 1.8GHz

### Memory

- 1GB DDR3 1333MHz SODIMM (up to 4GB)

### Expansion

- Mini PCIe socket (USB) x 1 (for 3.5G module)
- 1 x GPS module
- Mini PCIe socket (PCIe + USB) x 1 (for WLAN module)

### I/O Interfaces - Front

- 1 x DVI-I connector with DVI-D and VGA output
- 1 x 26-pin circular connector in support of RS-232/422/485 with isolation, 4-channel digital input and 4-channel digital output
- 1 x USB 2.0 with M12 connector
- 1 x Mic-in & 1 x Line-out
- 3 x 10/100 Ethernet with M12 connector
- Wireless communication
  - 1 x External accessible SIM card socket
  - 3 x Antenna holes for WWAN/ WLAN/ GPS
- 4 x LED for power, SSD, WWAN and WLAN
- DC Input
  - 24V with 500V isolated (range: 16.8V ~ 30V)
  - Optional: 110V with 1.5KV isolation (range: 66V ~ 154V)

### I/O Interfaces - Rear

- SSD accessible
- 2 x USB 2.0

### Expandable Storage

- 1 x SATA 2.5" SSD Bay
- 1 x CFast slot with protection cover

### Dimensions

- 260mm (W) x 178mm (D) x 70mm (H) (10.24"x 7"x 2.76")

### Construction

- Aluminum enclosure with fanless design

### Environment

- Operating temperatures
  - Ambient with air: -40°C to 55°C (EN50155 Class T2)
- Storage temperatures: -40°C to 80°C
- Damp heat test: 55°C, 95% RH (non-operating, EN 50155)
- Relative humidity: 0% to 90% (non-condensing)
- Vibration (random):
  - Compliance with EN61373 Category 1 Class B
- Shock:
  - Compliance with EN61373 Category 1 Class B

### Certifications

- CE approval
- FCC Class A
- Compliance with EN50155



# Getting to Know nROK 3000

## Front Panel

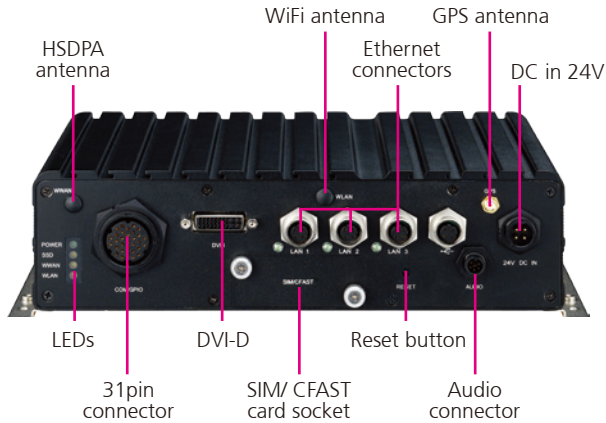

## 31pin Connector

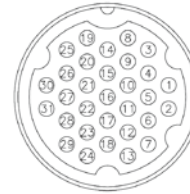

Pin	Definition	Pin	Definition
1	RS422_RX+_A	2	SP_TXD_1
3	RS422_RX-_A	4	SP_RI_1
5	RS422_TX+_A	6	SP_DTR_1
7	RS422_TX-_A	8	SP_CTS_1
9	RS485_TX+_A	10	SP_DCD_1
11	RS485_TX-_A	12	SP_RTS_1
13	RS4852_TX+_A	14	SP_RXD_1
15	RS4852_TX-_A	16	SP_DSR_1
17	NC	18	NC
19	NC	20	NC
21	ISO1_GND	22	ISO1_GND
23	G_I_1	24	G_O_1
25	G_I_2	26	G_O_2
27	G_I_3	28	G_O_3
29	G_I_4	30	G_O_4
31	N/A		

### Pin Map

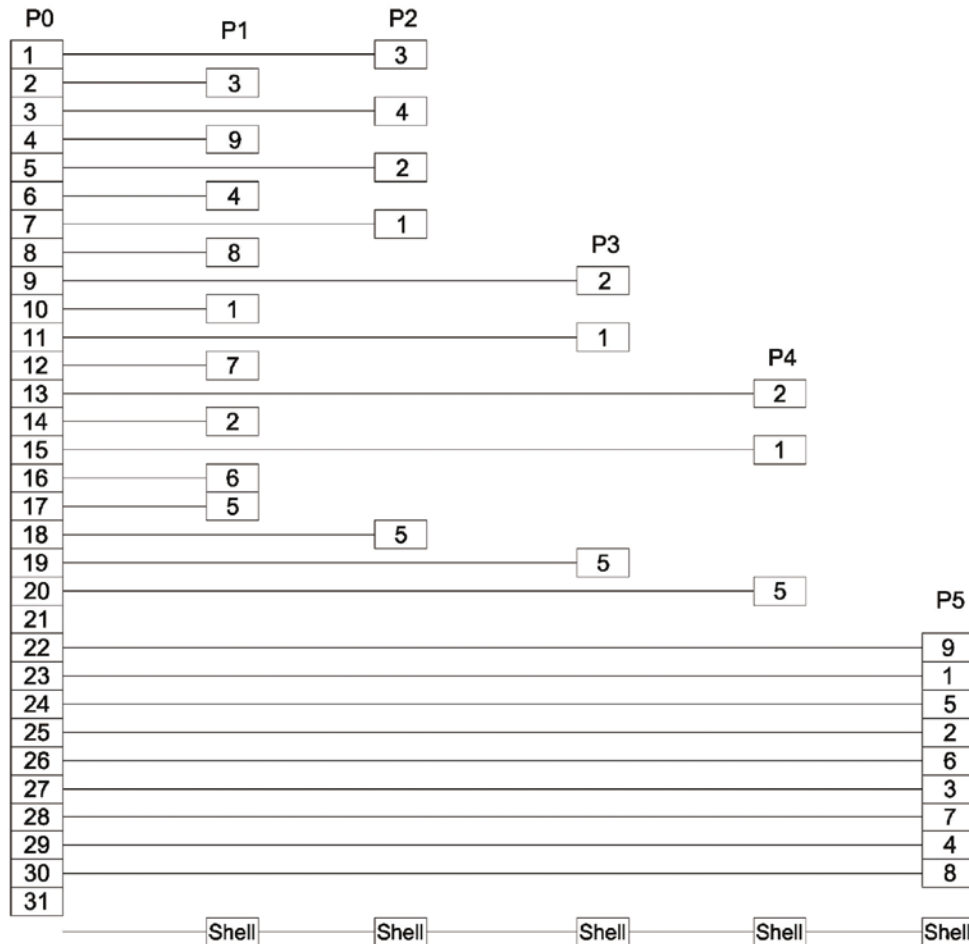

## Getting to Know nROK 3000

### VGA and DVI Connector

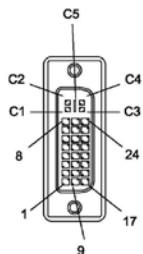

Pin	Definition	Pin	Definition
1	CH_TX2_N	2	CH_TX2_P
3	CH_GND	4	NC
5	NC	6	DVI_I_DDC_C_R
7	DVI_I_DDC_D_R	8	VGA1_VSYNC
9	CH_TX1_N	10	CH_TX1_P
11	CH_GND	12	NC
13	NC	14	VGA1_PWR_L
15	CH_GND	16	HPDET_I
17	CH_TX0_N	18	CH_TX0_P
19	CH_GND	20	VGA1_DDCCLK
21	VGA1_DDCCDAT	22	NC
23	CH_CLK_P	24	CH_CLK_N
C1	VGA1_RED	C2	VGA1_GREEN
C3	VGA1_BLUE	C4	VGA1_HSYNC
C5	CH_GND; M_DET		

### Audio Connector



Pin	Definition	Pin	Definition
1	SURR_OUT_L_CA	2	SURR_JD
3	SURR_OUT_R_CA	4	MIC_OUT-R
5	MIC_JD	6	C_GND

## Getting to Know nROK 3000

### M12 FOR LAN

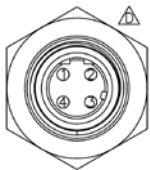

Pin	Definition	Pin	Definition
1	LAN_MDI_OP_R	2	LAN_MDI_1P_R
3	LAN_MDI_ON_R	4	LAN_MDI_1N_R

### M12 FOR USB

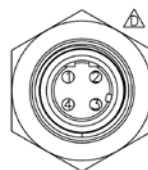

Pin	Definition	Pin	Definition
1	USB_ON	2	USB_VCC0
3	USB_OP	4	UGND_1

## Getting to Know nROK 3000

### POWER Connector

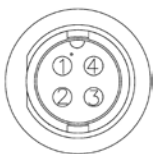

Pin	Definition	Pin	Definition
1	DC INPUT +	2	DC INPUT -
3	IGNITION SIGNAL INPUT	4	CHASSIS GND

NOTE: Only nROK3000-A supports ignition function

### External POWER Cable

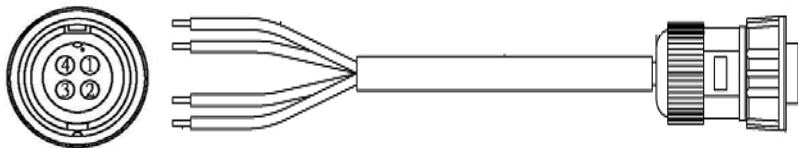

Pin	Definition	Pin	Definition
1	DC INPUT +(RED)	2	DC INPUT -(BLACK)
3	IGNITION SIGNAL INPUT(YELLOW)	4	CHASSIS GND(GREEN)

### SIM Card Socket

nROK3000 can be internally integrated with a 3.5G Mini Card module.

The SIM card bracket is on the board. When using the GPRS/UMTS/HSDPA function, insert the SIM card into the SIM card socket. Make sure to turn off nROK3000 before inserting the SIM card.

### CFast Socket

nROK3000 provides CFast Socket, it can be used in storage and also can support system driver.

### Reset Button

Press this button to restart nROK3000.

### WIFI/HSDPA Module Antenna Mounting Hole

The antenna mounting holes are used to mount and connect antennas to the WIFI/HSDPA module.

## Getting to Know nROK 3000

### Rear Panel



### Removable SSD tray

nROK 3000 allows data to be transmitted over network and stored in a convenient SSD (Solid-State Drive) or CFast card for better vibration and shock protection.

### USB Ports x 2

The USB port complies with USB 2.0 specifications. The special cover design is for water proof protection.

nROK 3000

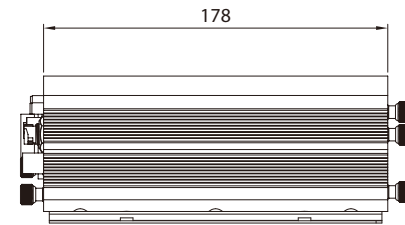
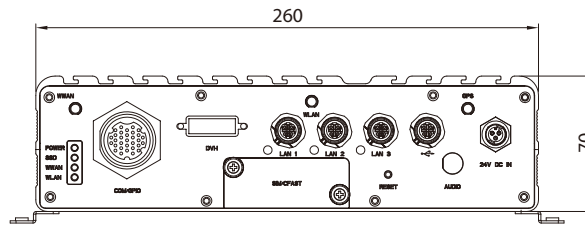
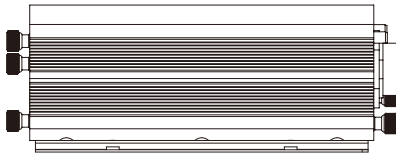
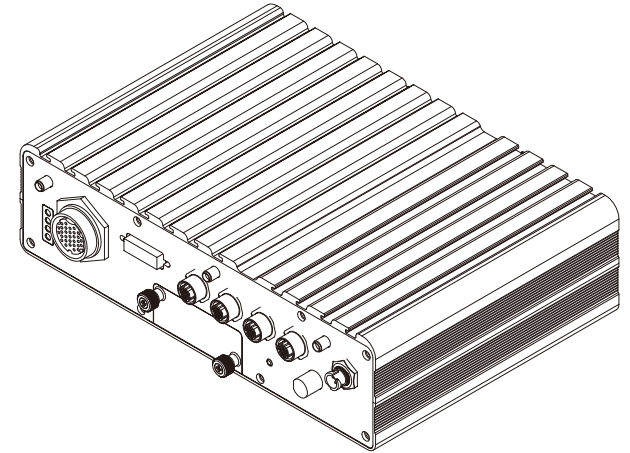
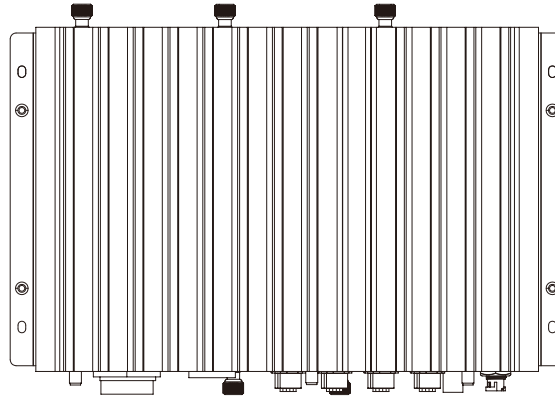
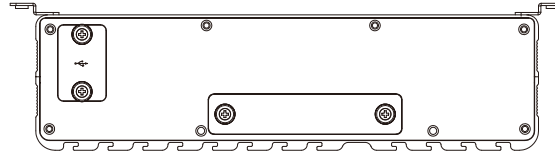

# Chapter 2: Jumpers and Connectors

This chapter describes how to set the jumpers on the motherboard. Note that the following procedures are generic for all nROK3000 series.

## Before You Begin

- Ensure you have a stable, clean working environment. Dust and dirt can get into components and cause a malfunction. Use containers to keep small components separated.
- Adequate lighting and proper tools can prevent you from accidentally damaging the internal components. Most of the procedures that follow require only a few simple tools, including the following:
  - A Philips screwdriver
  - A flat-tipped screwdriver
  - A set of jewelers Screwdrivers
  - A grounding strap
  - An anti-static pad
- Using your fingers can disconnect most of the connections. It is recommended that you do not use needle-nosed pliers to disconnect connections as these can damage the soft metal or plastic parts of the connectors.
- Before working on internal components, make sure that the power is off. Ground yourself before touching any internal components, by touching a metal object. Static electricity can damage many of the electronic components. Humid environment tend to have less static electricity than

dry environments. A grounding strap is warranted whenever danger of static electricity exists.

## Precautions

Computer components and electronic circuit boards can be damaged by discharges of static electricity. Working on the computers that are still connected to a power supply can be extremely dangerous.

Follow the guidelines below to avoid damage to your computer or yourself:

- Always disconnect the unit from the power outlet whenever you are working inside the case.
- If possible, wear a grounded wrist strap when you are working inside the computer case. Alternatively, discharge any static electricity by touching the bare metal chassis of the unit case, or the bare metal body of any other grounded appliance.
- Hold electronic circuit boards by the edges only. Do not touch the components on the board unless it is necessary to do so. Don't flex or stress the circuit board.
- Leave all components inside the static-proof packaging that they shipped with until they are ready for installation.
- Use correct screws and do not over tighten screws.



## Jumper

A jumper is the simplest kind of electric switch. It consists of two metal pins and a cap. When setting the jumpers, ensure that the jumper caps are placed on the correct pins. When the jumper cap is placed on both pins, the jumper is **short**. If you remove the jumper cap, or place the jumper cap on just one pin, the jumper is **open**.

Refer to the illustrations below for examples of what the 2-pin and 3-pin jumpers look like when they are short (on) and open (off).

Two-Pin Jumpers: Open (Left) and Short (Right)

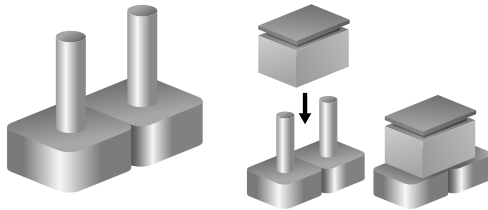

Three-Pin Jumpers: Pins 1 and 2 Are Short

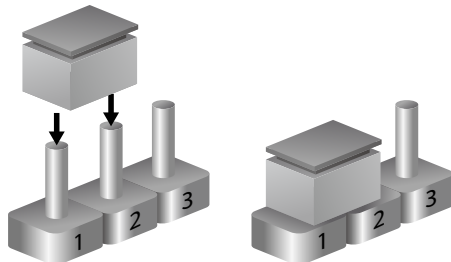

## Locations of the Jumpers and Connectors

The figure below is the main board which is the board used in the nROK3000 system. It shows the locations of the jumpers and connectors.

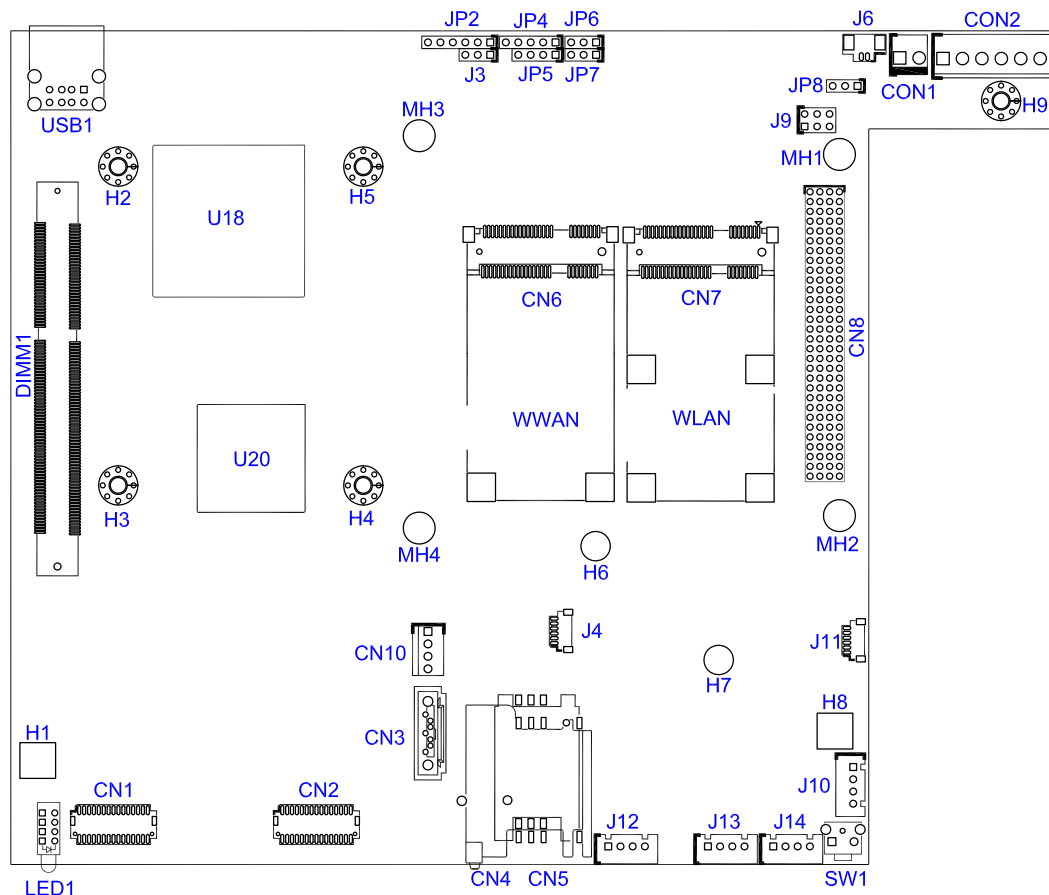

## Jumper Settings

(\*) for default setting

### IGNITION Select (JP7)

Pin No.	Status	Function Description
1-2	Short	IGNITION
2-3(*)	Short*	+12V

NOTE: Only nROK3000-A supports ignition function

### IGNITION Select ( JP8) (default NC)

Pin No.	Status	Function Description
1-2	Short	IGNITION
2-3	Short	+12V

### CMOS Input Voltage Select (J3)

Pin No.	Status	Function Description
1-2(*)	Short*	VBAT IN
2-3	Short	Clear CMOS

### TEMP SENSOR (JP5)

Pin No.	Function Description
1	SENSOR+
2	GND

### PCI104 VI/O Select Voltage (J9 )

Pin No.	Status	Function Description
1-4(*)	Short*	+3.3V
3-6	Short	+5V

### MCU Download (JP4)

Pin	Function Description
1	+V3.3ALW
2	C2D
3	MRST
4	C2CK
5	GND
6	WP
7	SI
8	GND

### GAL Download (JP2)

Pin	Function Description
1	+V3.3S
2	GND
3	TCK
4	TDO
5	TDI
6	TMS

### MCU COM PORT (JP6)

Pin No.	Status	Function Description
1	TX	+3.3V
2	RX	+5V
3	GND	

## Connectors

### UART CONNECTOR (RS232/422/485&GPIO) (CN1)

A. Connector size: 2 x 15 = 30 Pins PIN Header, ( 1.0 mm Pitch)

B. Connector location:

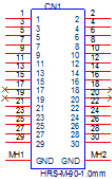

#### Connector pin definition

Pin	Definition	Pin	Definition
1	RS422_RX+_A	2	SP_TXD_1
3	RS422_RX-_A	4	SP_RI_1
5	RS422_TX+_A	6	SP_DTR_1
7	RS422_TX-_A	8	SP_CTS_1
9	RS485_TX+_A	10	SP_DCD_1
11	RS485_TX-_A	12	SP_RTS_1
13	RS4852_TX+_A	14	SP_RXD_1
15	RS4852_TX-_A	16	SP_DSR_1
17	NC	18	NC
19	NC	20	NC
21	ISO1_GND	22	ISO1_GND
23	G_I_1	24	G_O_1
25	G_I_2	26	G_O_2
27	G_I_3	28	G_O_3
29	G_I_4	30	G_O_4

### DVI+VGA CONNECTOR (CN2)

A. Connector size: 2 x 15 = 30 Pins PIN Header, ( 1.0 mm Pitch)

B. Connector location:

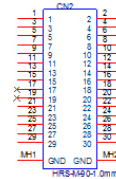

#### Connector pin definition

Pin	Definition	Pin	Definition
1	CH_CLK_N	2	DVI_I_5V
3	CH_CLK_P	4	HPDET_I
5	CH_TX0_N	6	DVI_I_DDC_D_R
7	CH_TX0_P	8	DVI_I_DDC_C_R
9	CH_TX1_N	10	CH_GND
11	CH_TX1_P	12	CH_GND
13	CH_TX2_N	14	CH_GND
15	CH_TX2_P	16	CH_GND
17	NC	18	NC
19	NC	20	NC
21	CH_GND	22	VGA1_HSYNC
23	VGA1_RED	24	VGA1_VSYNC
25	VGA1_BLUE	26	VGA1_DDCDAT
27	VGA1_GREEN	28	VGA1_DDCCLK
29	M_DET	30	VGA1_PWR_L

## Connectors

### GPS Connector COM6 (J4)

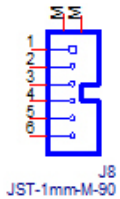

#### Connector pin definition

Pin	Definition	Pin	Definition
1	GPS_BAT	2	GPS_LED#
3	SP_TX1	4	SP_RX1
5	GND	6	VCC3_3S

### AUDIO CONNECTOR (J11)

A. Connector size: 1 x 6 = 6 Pins PIN Header, ( 1.0 mm Pitch )

B. Connector location:

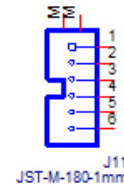

#### Connector pin definition

Pin	Definition	Pin	Definition
1	SURR_OUT_L_CA	2	SURR_JD
3	SURR_OUT_R_CA	4	MIC_OUT-R
5	MIC_JD	6	C_GND

## Connectors

### GAL Programmer PIN Header (JP2)

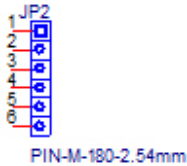

#### Connector pin definition

Pin	Definition	Pin	Definition
1	VCC3_3	2	GND
3	TCK	4	TDO
5	TDI	6	TMS

### MCU Programmer PIN Header (JP4)

A. Connector size: 1 x 6 = 6 Pins PIN Header, ( 1.0 mm Pitch )

B. Connector location:

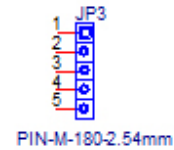

#### Connector pin definition

Pin	Definition	Pin	Definition
1	+3.3ALW	2	C2D
3	MRST	4	C2CK
5	GND		

## Connectors

### LAN connector (J5)(J7)(J8)

- A. Connector size: M12
- B. Connector location

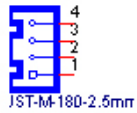

#### Connector pin definition

Pin	Definition	Pin	Definition
1	LAN_MDI_OP_R	2	LAN_MDI_ON_R
3	LAN_MDI_1P_R	4	LAN_MDI_1N_R

### FRONT USB connector (J10)

- A. Connector size: M12
- B. Connector location

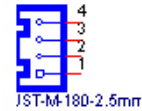

#### Connector pin definition

Pin	Definition	Pin	Definition
1	USB_ON	2	USB_OP
3	USB_VCC0	4	UGND_1

## Connectors

### REAR USB connector (USB1)

Connector location:



#### Connector pin definition

Pin	Definition	Pin	Definition
1	VCC	2	DATA1-
3	DATA1+	4	GND
5	VCC	6	DATA-
7	DATA+	8	GND

### PCI-104 VI/O voltage setting (J9)

A. Connector size: M12

B. Connector location

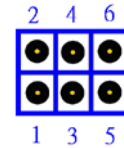

#### Connector pin definition

Pin No.	Status	Function Description
(1-3)(2-4) (*)	Short	+3.3V
(3-5)(4-6)	Short	+5V



## Connectors

### PCI-104 connector (CN21)

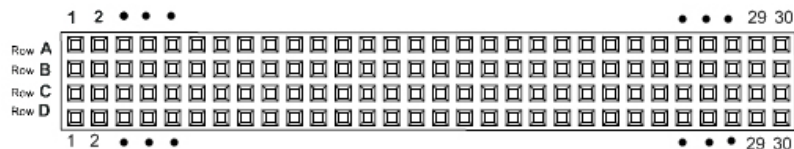

#### Connector pin definition

Pin	A	B	C	D
1	GND	Reserved	+5	AD00
2	V/I/O	AD02	AD01	+5V
3	AD05	GND	AD04	AD03
4	C/BE0#	AD07	GND	AD06
5	GND	AD09	AD08	GND
6	AD11	V/I/O	AD10	M66EN
7	AD14	AD13	GND	AD12
8	+3.3V	C/BE1#	AD15	+3.3V
9	SERR3	GND	Reserved	PAR
10	GND	PERR#	+3.3V	Reserved
11	STOP#	+3.3V	LOCK#	GND
12	+3.3V	TRDY#	GND	DEVSEL#
13	FRAME#	GND	IRDY#	+3.3V
14	GND	AD16	+3.3V	C/BE2#
15	AD18	+3.3V	AD17	GND

Pin	A	B	C	D
16	AD21	AD20	GND	AD19
17	+3.3V	AD23	AD22	+3.3V
18	IDSEL0	GND	IDSEL1	IDSEL2
19	AD24	C/BE3#	V/I/O	IDSEL3
20	GND	AD26	AD25	GND
21	AD29	+5V	AD28	AD27
22	+5V	AD30	GND	AD31
23	REQ0#	GND	REQ1#	V/I/O
24	GND	REQ2#	+5V	GNT0#
25	GNT1#	V/I/O	GNT2#	GND
26	+5V	CLK0	GND	CLK1
27	CLK2	+5V	CLK3	GND
28	GND	INTD#	+5V	RST#
29	+12V	INTA#	INTB#	INTC#
30	+12V	REQ3#	GNT3#	GND

## Connectors

### RESET BUTTON (SW2)



#### Connector pin definition

Pin	Function Description
1	GND
2	RST_BTN#

### MCU COM PORT (JP6)



PIN-M-180-2.54mm

#### Connector pin definition

Pin	Function Description
1	TX
2	RX
3	GND

## Connectors

### TEMP SENSOR (JP5)



#### Connector pin definition

Pin	Function Description
1	SENSOR+
2	GND

### POWER INPUT

#### +12V DC Power Input Connector (CON1)

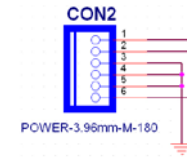

#### Connector pin definition

Pin	Function Description
1	+12v
2	+12v
3	GND
4.	GND
5.	GND
6.	Ignition

## Connectors

### 12VSD DC Power Input Connector (CON2)

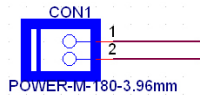

#### Connector pin definition

Pin	Function Description
1	12VSD
2	GND

### 12VSD GPIO (J6)

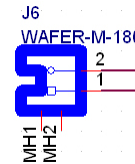

#### Connector pin definition

Pin	Function Description
1	3VSB
2	GND

## Connectors

### POWER ON ,HD ,WWAN ,WLAN Active LED (LED1)



#### Connector pin definition

Pin	Function Description
1	POWER LED
2	HD LED
3	WWAN LED
4	WLAN LED

### Serial-ATA (CN3)

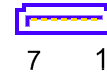

#### Connector pin definition

Pin	Definition	Pin	Definition
1	GND	2	SATA_TXP0 -
3	SATA_TXN0	4	GND
5	SATA_RXN0	6	SATA_RXP0
7	GND		

## Connectors

### Serial-ATA POWER INPUT (J1)



#### Connector pin definition

Pin	Definition	Pin	Definition
1	12V	2	GND
3	GND	4	VCC5

### Mini-PCle (3.5G)(CN6)

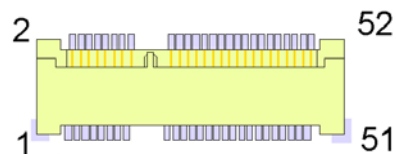

#### Connector pin definition

Pin	Definition	Pin	Definition	Pin	Definition	Pin	Definition
1	MIC +	2	+V3.3S	27	GND	28	NC
3	MIC -	4	GND	29	GND	30	NC
5	SPK +	6	NC	31	NC	32	NC
7	GND	8	USIM PWR	33	RESET	34	GND
9	GND	10	USIM DATA	35	GND	36	USB_D-
11	VCC_MSM26_DIG	12	USIM CLK	37	GND	38	USB_D+
13	NC	14	USIM RST	39	+V3.3S	40	GND
15	GND	16	NC	41	+V3.3S	42	LED_WWAN#
17	NC	18	GND	43	GND	44	NC
19	NC	20	W_DISABLE#	45	NC	46	NC
21	GND	22	NC	47	NC	48	NC
23	NC	24	NC	49	NC	50	GND
25	NC	26	GND	51	NC	52	+V3.3S

## Connectors

### Mini-PCIe (WLAN)(CN7)

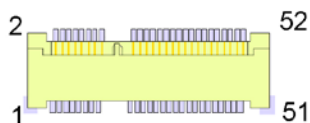

#### Connector pin definition

Pin	Definition	Pin	Definition	Pin	Definition	Pin	Definition
1	WAKE#	2	+V3.3S	27	GND	28	+V1.5S
3	NC	4	GND	29	GND	30	SMB_CLK
5	NC	6	+V1.5S	31	PETn0	32	SMB_DATA
7	CLKREQ#	8	NC	33	PETp0	34	GND
9	GND	10	NC	35	GND	36	USB_D-
11	REFCLK-	12	NC	37	NC	38	USB_D+
13	REFCLK+	14	NC	39	NC	40	GND
15	GND	16	NC	41	NC	42	LED_WWAN#
17	NC	18	GND	43	NC	44	LED_WLAN#
19	NC	20	DISABLE#	45	NC	46	LED_WPAN#
21	GND	22	PERST#	47	NC	48	+V1.5S
23	PERn0	24	+3.3S	49	NC	50	GND
25	PERp0	26	GND	51	NC	52	+V3.3S

### SIM CARD CONNECTOR (CN4) (CN5)



#### Connector pin definition

Pin	Definition	Pin	Definition
C1	POWER VOLTAGE	C2	RESET SIGNAL
C3	CLOCK SIGNAL	C5	GND
C6	VPP:PROGRAM VOLTAGE	C7	I/O
SW	Contact present switch		

# Chapter 3: System Setup

## Removing the Chassis Cover



Prior to removing the chassis cover, make sure the unit's power is off and disconnected from the power sources to prevent electric shock or system damage.

1. The screws on the chassis are used to secure the cover to the chassis. Remove these screws and put them in a safe place for later use



Front View



Rear View



Base View





## Removing the Chassis Cover

2. Lift the cover upward then remove it from the chassis.



## Installing the Wi-Fi and GPRS/UMTS/HSDPA Modules

1. Remove the screws and SSD tray.

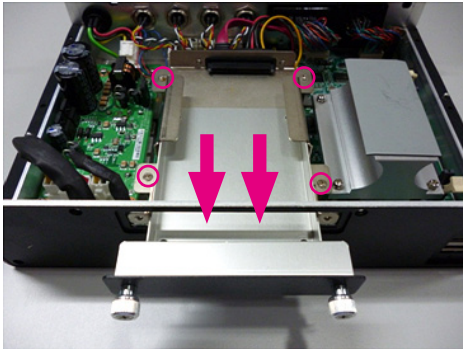

2. The Mini PCI Express slot shown below is used to install a Wi-Fi, 3.5G communication module such as GPRS, UMTS or HSDPA module.

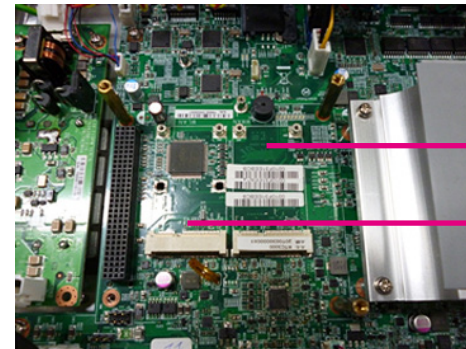

WWAN  
Mini PCI  
Express slot

Wi-Fi  
Mini PCI  
Express slot

3. Insert the module into the Mini PCI Express slot at a 45 degrees angle until the gold-plated connector on the edge of the module completely disappears inside the slot.
4. Push the module down then secure it with mounting screws.
5. Attach one end of the RF cable onto the module

## Installing SSD Drive

1. Remove the SSD drive tray.

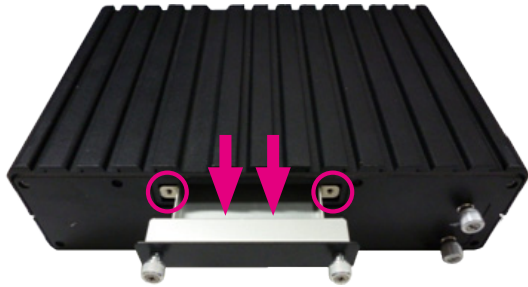

2. Place the SSD drive into the tray and then tighten the four screws.



## Installing SSD Drive

3. Installing the HDD tray, and then tighten the screws to secure the drive to the chassis.

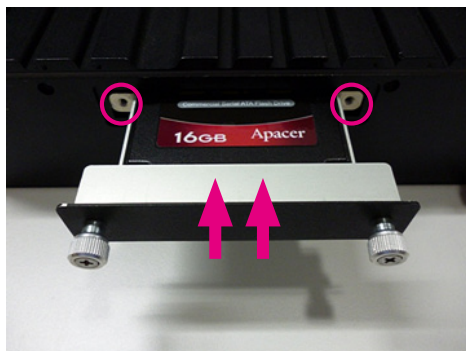

## Rackmount Brackets

The rackmount brackets provide a convenient and economical way of mounting the system on the wall.

1. The mounting holes are located at the bottom of the system. Secure the brackets on each side of the system using the provided mounting screws.

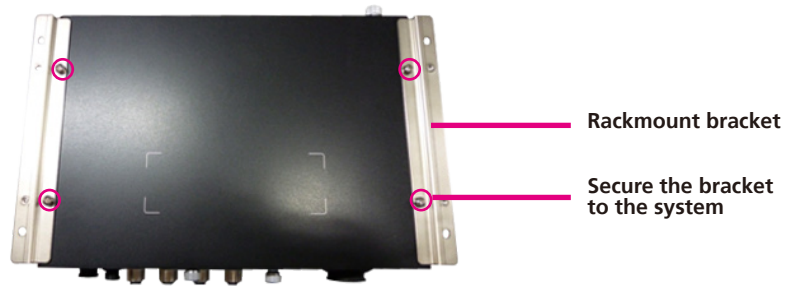

2. Now mount the system on the wall by fastening screws through the bracket's mounting holes.

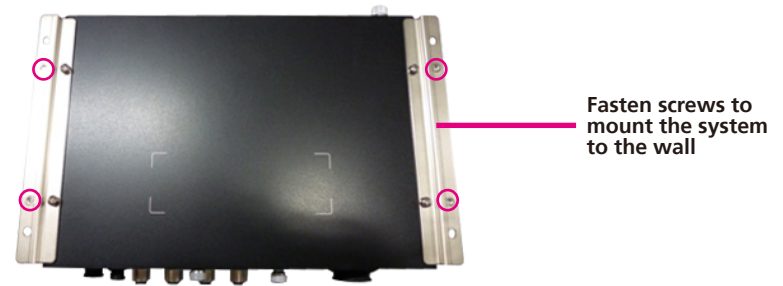

# Appendix A: I/O Address Function

(\*) for default setting

## GPIO LED / UMTS LED / Ignition Status

I/O port : 0EE0H

Bit	Function Description
Bit 0	GPIO LED 0: OFF (*) 1: ON
Bit 1	UMTS LED 0: LED for Wireless (*) 1: LED for 3.5G and Wireless

## GPIO

I/O port : 0EE4H

Bit	Function Description
Bit 0-3	GPO 1-4
Bit 4-7	GPI 1-4

**WDT**

I/O port : 0EE5H

Bit	Function Description
Bit 3	WDT Disable/Enable 0: Disable (*) 1: Enable

**Bit 2, 1, 0: Time Setting**

Bit 2~0	Time (sec)
000	1 (*)
001	2
010	4
011	8
100	16
101	32
110	64
111	128

Auto clear WDT timer when reading/writing I/O port 0EE5H.

**Onboard Module Disable/Enable(1)**

I/O port : 0EE6H

Bit	Function Description
Bit 0	3.5G module 0: Disable 1: Enable (*)
Bit 1	WLAN module 0: Disable 1: Enable (*)

### Delay Time Setting

I/O port : 0EE7H

Bit7	Power On Delay
0	Disable(*)
1	Enable

Bit6	Power Off Delay
0	Disable(*)
1	Enable

### Delay On Time Setting

Bit3~5	Function Description
000	10 sec
001	30 sec
010	1 min
011	5 min
100	10 min
101	15 min
110	30 min
111	1 hour

### Delay Off Time Setting

Bit 2~0	Time (sec)
000	20 sec
001	1 min
010	5 min
011	10 min
100	30 min
101	1 hour
110	6 hour
111	18 hour



**Setup Command**

I/O port : 0EE9H

Restart the Setup Command

<b>Enable byte</b>
<b>AA</b>

Using end byte to tell the data flow end

<b>Data</b>	<b>End byte</b>
(Delay time)(Startup/Shutdown voltage setting)	55

**Onboard Module Disable/Enable(1)**

I/O port : 0EEAH

<b>Enable byte</b>
<b>AA</b>

**GAL Download control**

I/O port : 0EEBH

Restart the Setup Command

<b>Enable byte</b>
<b>AA</b>

# Appendix B: Power Consumption

## Test Equipment/Tool

DUT#1 : nROK3000 with SSD

DUT#2 : nROK3000 with SSD and 3.5G module

Windows XP

Burn-in Software: Version 5.0

## Test Condition

Room temperature

Power supply graduation: 12V 5A

## Test Procedure:

1. Start of all function at DUT and measure power consumption.
2. Get system into suspend mode and measure power consumption.

Unit	Idle Mode	100% Burn-in Mode	S3	S4	S5
DUT#1	1.03A	1.18A	90mA	10mA	10mA
DUT#2	1.13A	1.24A	140mA	50mA	50mA

\* Device: N/A