

NEXCOM International Co., Ltd.

**Mobile Computing Solutions**  
**Vehicle Mount Computer**  
**VMC 1000**  
User Manual

# Contents

## Preface

Copyright .....	iv
Disclaimer .....	iv
Acknowledgements .....	iv
Regulatory Compliance Statements .....	iv
Declaration of Conformity.....	iv
RoHS Compliance .....	v
Warranty and RMA .....	vi
Safety Information .....	vii
Installation Recommendations.....	vii
Safety Precautions.....	viii
Technical Support and Assistance.....	ix
Conventions Used in this Manual.....	ix
Global Service Contact Information.....	x
Package Contents.....	xii
Ordering Information.....	xiii

## Chapter 1: Product Introduction

Overview .....	1
Key Features .....	1
Hardware Specifications.....	3
Getting to Know VTC 1000 .....	7
Front Panel .....	7
Rear Panel.....	8

Lateral Side .....	9
I/O Connectors .....	0
GPS Connector .....	10
Multi-Connector .....	11
DC Power Connector .....	12
DC Power Cable Connector .....	12
SIM CARD Connector .....	13
USB Connector .....	13
Mic in Jack .....	14
Line-out Jack .....	14

## Chapter 2: Jumpers And Connectors

Before You Begin .....	15
Precautions.....	15
Jumper .....	16
Locations of the Jumpers and Connectors.....	17
Panel Connector .....	18
Touch Screen Connector .....	19
Button & Sensor & LED Connector .....	19
Speaker Connector .....	20
8051 Download Connector .....	20
RTC Control Connector .....	21
RTC Battery Connector .....	21
Backlight Connector(power) .....	22
Backlight Connector(data) .....	22

CCD Conector .....	23
PORT 80 Connector .....	23
MINI PCIE Connector .....	24
GAL Download Connector .....	27
Input Voltage Control Switch .....	27
POWER_IN Connector .....	28

### **Chapter 3: System Setup**

Installing a WLAN module or WWAN module.....	29
----------------------------------------------	----

### **Appendix A: I/O Address Function**

I/O Address Function .....	31
----------------------------	----

### **Appendix B: Vehicle Power Management Setup**

Vehicle Power Management Setup.....	37
-------------------------------------	----

### **Appendix C: Power Consumption**

Power Consumption .....	44
-------------------------	----

### **Appendix D: SMS Wake-up setting**

SMS Wake-up setting .....	45
---------------------------	----

### **Appendix E: RTC Wake-up setting**

RTC Wake-up setting .....	51
---------------------------	----

# Preface

## Copyright

This publication, including all photographs, illustrations and software, is protected under international copyright laws, with all rights reserved. No part of this manual may be reproduced, copied, translated or transmitted in any form or by any means without the prior written consent from NEXCOM International Co., Ltd.

## Disclaimer

The information in this document is subject to change without prior notice and does not represent commitment from NEXCOM International Co., Ltd. However, users may update their knowledge of any product in use by constantly checking its manual posted on our website: <http://www.nexcom.com>. NEXCOM shall not be liable for direct, indirect, special, incidental, or consequential damages arising out of the use of any product, nor for any infringements upon the rights of third parties, which may result from such use. Any implied warranties of merchantability or fitness for any particular purpose is also disclaimed.

## Acknowledgements

VMC 1000 is a trademark of NEXCOM International Co., Ltd. All other product names mentioned herein are registered trademarks of their respective owners.

## Regulatory Compliance Statements

This section provides the FCC compliance statement for Class A devices and describes how to keep the system CE compliant.

## Declaration of Conformity

### FCC

This equipment has been tested and verified to comply with the limits for a Class A digital device, pursuant to Part 15 of FCC Rules. These limits are designed to provide reasonable protection against harmful interference when the equipment is operated in a commercial environment. This equipment generates, uses, and can radiate radio frequency energy and, if not installed and used in accordance with the instructions, may cause harmful interference to radio communications. Operation of this equipment in a residential area (domestic environment) is likely to cause harmful interference, in which case the user will be required to correct the interference (take adequate measures) at their own expense.

### CE

The product(s) described in this manual complies with all applicable European Union (CE) directives if it has a CE marking. For computer systems to remain CE compliant, only CE-compliant parts may be used. Maintaining CE compliance also requires proper cable and cabling techniques.

## RoHS Compliance

### NEXCOM RoHS Environmental Policy and Status Update



NEXCOM is a global citizen for building the digital infrastructure. We are committed to providing green products and services, which are compliant with European Union RoHS (Restriction on Use of Hazardous Substance in Electronic Equipment) directive 2002/95/EU, to be your trusted green partner and to protect our environment.

RoHS restricts the use of Lead (Pb) < 0.1% or 1,000ppm, Mercury (Hg) < 0.1% or 1,000ppm, Cadmium (Cd) < 0.01% or 100ppm, Hexavalent Chromium (Cr6+) < 0.1% or 1,000ppm, Polybrominated biphenyls (PBB) < 0.1% or 1,000ppm, and Polybrominated diphenyl Ethers (PBDE) < 0.1% or 1,000ppm.

In order to meet the RoHS compliant directives, NEXCOM has established an engineering and manufacturing task force in to implement the introduction of green products. The task force will ensure that we follow the standard NEXCOM development procedure and that all the new RoHS components and new manufacturing processes maintain the highest industry quality levels for which NEXCOM are renowned.

The model selection criteria will be based on market demand. Vendors and suppliers will ensure that all designed components will be RoHS compliant.

### How to recognize NEXCOM RoHS Products?

For existing products where there are non-RoHS and RoHS versions, the suffix "(LF)" will be added to the compliant product name.

All new product models launched after January 2006 will be RoHS compliant. They will use the usual NEXCOM naming convention.

# Warranty and RMA

## NEXCOM Warranty Period

NEXCOM manufactures products that are new or equivalent to new in accordance with industry standard. NEXCOM warrants that products will be free from defect in material and workmanship for 2 years, beginning on the date of invoice by NEXCOM. HCP series products (Blade Server) which are manufactured by NEXCOM are covered by a three year warranty period.

## NEXCOM Return Merchandise Authorization (RMA)

- ✘ Customers shall enclose the “NEXCOM RMA Service Form” with the returned packages.
- ✘ Customers must collect all the information about the problems encountered and note anything abnormal or, print out any on-screen messages, and describe the problems on the “NEXCOM RMA Service Form” for the RMA number apply process.
- ✘ Customers can send back the faulty products with or without accessories (manuals, cable, etc.) and any components from the card, such as CPU and RAM. If the components were suspected as part of the problems, please note clearly which components are included. Otherwise, NEXCOM is not responsible for the devices/parts.
- ✘ Customers are responsible for the safe packaging of defective products,

making sure it is durable enough to be resistant against further damage and deterioration during transportation. In case of damages occurred during transportation, the repair is treated as “Out of Warranty.”

- ✘ Any products returned by NEXCOM to other locations besides the customers’ site will bear an extra charge and will be billed to the customer.

## Repair Service Charges for Out-of-Warranty Products

NEXCOM will charge for out-of-warranty products in two categories, one is basic diagnostic fee and another is component (product) fee.

### System Level

- ✘ Component fee: NEXCOM will only charge for main components such as SMD chip, BGA chip, etc. Passive components will be repaired for free, ex: resistor, capacitor.
- ✘ Items will be replaced with NEXCOM products if the original one cannot be repaired. Ex: motherboard, power supply, etc.
- ✘ Replace with 3<sup>rd</sup> party products if needed.
- ✘ If RMA goods can not be repaired, NEXCOM will return it to the customer without any charge.

## Board Level

- ✘ Component fee: NEXCOM will only charge for main components, such as SMD chip, BGA chip, etc. Passive components will be repaired for free, ex: resistors, capacitors.

If RMA goods can not be repaired, NEXCOM will return it to the customer without any charge.

## Warnings

Read and adhere to all warnings, cautions, and notices in this guide and the documentation supplied with the chassis, power supply, and accessory modules. If the instructions for the chassis and power supply are inconsistent with these instructions or the instructions for accessory modules, contact the supplier to find out how you can ensure that your computer meets safety and regulatory requirements.

## Cautions

Electrostatic discharge (ESD) can damage system components. Do the described procedures only at an ESD workstation. If no such station is available, you can provide some ESD protection by wearing an antistatic wrist strap and attaching it to a metal part of the computer chassis.

## Safety Information

Before installing and using the device, note the following precautions:

- Read all instructions carefully.
- Do not place the unit on an unstable surface, cart, or stand.
- Follow all warnings and cautions in this manual.

- When replacing parts, ensure that your service technician uses parts specified by the manufacturer.
- Avoid using the system near water, in direct sunlight, or near a heating device.
- The load of the system unit does not solely rely for support from the rackmounts located on the sides. Firm support from the bottom is highly necessary in order to provide balance stability.

The computer is provided with a battery-powered real-time clock circuit. There is a danger of explosion if battery is incorrectly replaced. Replace only with the same or equivalent type recommended by the manufacturer. Discard used batteries according to the manufacturer's instructions.

## Installation Recommendations

Ensure you have a stable, clean working environment. Dust and dirt can get into components and cause a malfunction. Use containers to keep small components separated.

Adequate lighting and proper tools can prevent you from accidentally damaging the internal components. Most of the procedures that follow require only a few simple tools, including the following:

- A Philips screwdriver
- A flat-tipped screwdriver
- A grounding strap
- An anti-static pad

Using your fingers can disconnect most of the connections. It is recommended that you do not use needlenose pliers to disconnect connections as these can damage the soft metal or plastic parts of the connectors.

## Safety Precautions

1. Read these safety instructions carefully.
2. Keep this User Manual for later reference.
3. Disconnect this equipment from any AC outlet before cleaning. Use a damp cloth. Do not use liquid or spray detergents for cleaning.
4. For plug-in equipment, the power outlet socket must be located near the equipment and must be easily accessible.
5. Keep this equipment away from humidity.
6. Put this equipment on a stable surface during installation. Dropping it or letting it fall may cause damage.
7. Do not leave this equipment in either an unconditioned environment or in a above 40°C storage temperature as this may damage the equipment.
8. The openings on the enclosure are for air convection to protect the equipment from overheating. DO NOT COVER THE OPENINGS.
9. Make sure the voltage of the power source is correct before connecting the equipment to the power outlet.
10. Place the power cord in a way so that people will not step on it. Do not place anything on top of the power cord. Use a power cord that has been approved for use with the product and that it matches the voltage and current marked on the product's electrical range label. The voltage and current rating of the cord must be greater than the voltage and current rating marked on the product.
11. All cautions and warnings on the equipment should be noted.
12. If the equipment is not used for a long time, disconnect it from the power source to avoid damage by transient overvoltage.
13. Never pour any liquid into an opening. This may cause fire or electrical shock.
14. Never open the equipment. For safety reasons, the equipment should be opened only by qualified service personnel.
15. If one of the following situations arises, get the equipment checked by service personnel:
  - a. The power cord or plug is damaged.
  - b. Liquid has penetrated into the equipment.
  - c. The equipment has been exposed to moisture.
  - d. The equipment does not work well, or you cannot get it to work according to the user's manual.
  - e. The equipment has been dropped and damaged.
  - f. The equipment has obvious signs of breakage.
16. Do not place heavy objects on the equipment.
17. The unit uses a three-wire ground cable which is equipped with a third pin to ground the unit and prevent electric shock. Do not defeat the purpose of this pin. If your outlet does not support this kind of plug, contact your electrician to replace your obsolete outlet.
18. **CAUTION:** DANGER OF EXPLOSION IF BATTERY IS INCORRECTLY REPLACED. REPLACE ONLY WITH THE SAME OR EQUIVALENT TYPE RECOMMENDED BY THE MANUFACTURER. DISCARD USED BATTERIES ACCORDING TO THE MANUFACTURER'S INSTRUCTIONS.
19. The computer is provided with CD drives that comply with the appropriate safety standards including IEC 60825.



## Technical Support and Assistance

1. For the most updated information of NEXCOM products, visit NEXCOM's website at [www.nexcom.com](http://www.nexcom.com).
2. For technical issues that require contacting our technical support team or sales representative, please have the following information ready before calling:
  - Product name and serial number
  - Detailed information of the peripheral devices
  - Detailed information of the installed software (operating system, version, application software, etc.)
  - A complete description of the problem
  - The exact wordings of the error messages

### Warning!

1. Handling the unit: carry the unit with both hands and handle it with care.
2. Maintenance: to keep the unit clean, use only approved cleaning products or clean with a dry cloth.
3. CompactFlash: Turn off the unit's power before inserting or removing a CompactFlash storage card.

## Conventions Used in this Manual



Warning: Information about certain situations, which if not observed, can cause personal injury. This will prevent injury to yourself when performing a task.



Caution: Information to avoid damaging components or losing data.



Note: Provides additional information to complete a task easily.

## Battery - Safety Measures

### Caution

- Risk of explosion if battery is replaced by an incorrect type.
- Dispose of used batteries according to the instructions.

### Safety Warning



This equipment is intended for installation in a Restricted Access Location only.

## Resetting the Date and Time



Note: Remember to reset the date and time upon receiving the product. You can set them in the AMI BIOS. Refer to chapter 4 for more information.

# Global Service Contact Information

## Headquarters

### **NEXCOM International Co., Ltd.**

15F, No. 920, Chung-Cheng Rd.,  
ZhongHe District, New Taipei City, 23586,  
Taiwan, R.O.C.

Tel: +886-2-8226-7786

Fax: +886-2-8226-7782

[www.nexcom.com](http://www.nexcom.com)

## America

### **USA**

#### **NEXCOM USA**

2883 Bayview Drive,  
Fremont CA 94538, USA

Tel: +1-510-656-2248

Fax: +1-510-656-2158

Email: [sales@nexcom.com](mailto:sales@nexcom.com)

[www.nexcom.com](http://www.nexcom.com)

## Asia

### **Taiwan**

#### **Central Taiwan Office**

16F, No.250, Sec. 2, Chongde Rd.,  
Beitun Dist., Taichung City 406, R.O.C.

Tel: +886-4-2249-1179

Fax: +886-4-2249-1172

Email: [sales@nexcom.com.tw](mailto:sales@nexcom.com.tw)

[www.nexcom.com.tw](http://www.nexcom.com.tw)

## Japan

### **NEXCOM Japan**

9F, Tamachi Hara Bldg., 4-11-5, Shiba Minato-ku,  
Tokyo, 108-0014, Japan

Tel: +81-3-5419-7830

Fax: +81-3-5419-7832

Email: [sales@nexcom-jp.com](mailto:sales@nexcom-jp.com)

[www.nexcom-jp.com](http://www.nexcom-jp.com)

## China

### **NEXCOM China**

2F, Block 4, Venus Plaza, Bldg. 21,  
ZhongGuanCun Software Park, No. 8,  
Dongbeiwang West Rd., Haidian District,  
Beijing, 100193, China

Tel: +86-10-8282-6599

Fax: +86-10-8282-5955

Email: [sales@nexcom.cn](mailto:sales@nexcom.cn)

[www.nexcom.cn](http://www.nexcom.cn)

## Shanghai Office

Room 603/604, Huiyinmingzun Plaza Bldg., 1,  
No.609, Yunlin East Rd.,  
Shanghai, 200062, China

Tel: +86-21-5278-5868

Fax: +86-21-3251-6358

Email: [sales@nexcom.cn](mailto:sales@nexcom.cn)

[www.nexcom.cn](http://www.nexcom.cn)

## Shenzhen Office

Room1707, North Block, Pines Bldg.,  
No.7 Tairan Rd., Futian Area,  
Shenzhen, 518040, China  
Tel: +86-755-8332-7203  
Fax: +86-755-8332-7213  
Email: sales@nexcom.cn  
www.nexcom.cn

## Wuhan Office

1-C1804/ 1805, Mingze Liwan,  
No. 519 South Luoshi Rd.,  
Hongshan District,  
Wuhan, 430070, China  
Tel: +86-27-8722-7400  
Fax: +86-27-8722-7400  
Email: sales@nexcom.cn  
www.nexcom.cn

## Chengdu Office

9F, Shuxiangxie, Xuefu Garden,  
No.12 Section 1, South Yihuan Rd.,  
Chengdu, 610061, China  
Tel: +86-28-8523-0186  
Fax: +86-28-8523-0186  
Email: sales@nexcom.cn  
www.nexcom.cn

## Europe

### Italy

#### NEXCOM ITALIA S.r.l

Via Gaudenzio Ferrari 29,  
21047 Saronno (VA), Italia  
Tel: +39 02 9628 0333  
Fax: +39 02 9286 9215  
Email: nexcomitalia@nexcom.eu  
www.nexcomitalia.it

### United Kingdom

#### NEXCOM EUROPE

10 Vincent Avenue,  
Crownhill Business Centre,  
Milton Keynes, Buckinghamshire MK8 0AB,  
United Kingdom  
Tel: +44-1908-267121  
Fax: +44-1908-262042  
Email: sales.uk@nexcom.eu  
www.nexcom.eu

# Package Contents

Before continuing, verify that the VMC 1000 package that you received is complete. Your VMC 1000 package should have all the items listed in the following table.

Item	P/N	Name	Specification	Qty
1	5044440135X00	THERMAL PAD E-LIN	25x25x1mm K=5w/mk TP-1800G	4
2	5044440303X00	THERMAL PAD FOR VMC1000 E-LIN:TP1800G	25x25x2mm K=5w/mk	1
3	6023303701X00	(N)DB37 CABLE FOR VMC1000 SUNJET:SL812822805	D-SUB M37P SR L=300mm	1
4	60233PW236X00	(N)POWER DOCKING CABLE FOR VMC1000 SUNJET:SL812822822	UL2464 20AWG L=130mm	1
5	60233SAM05X00	GPS ANTENNA	5M /SMA180P	1
6	602DCD0405X00	CD DRIVER		1

# Ordering Information

The following provides ordering information for VMC 1000.

- **VMC 1000 (P/N: 10VC0100000X0)**
  - 7-inch All in One Vehicle Mount Computer with Touch Screen and Smart Brightness Control and Intel® Atom™ E640 1.0Ghz processor with 1GB DDR2, GPS module and GPS antenna

# Chapter 1: Product Introduction

## Overview



VMC 1000 Front View



VMC 1000 Rear View

## Key Features

- 7" WVGA TFT LCD with LED backlight
- Compact and fanless design
- Built-in Intel® Atom™ E640 1.0GHz processor
- Wake on RTC /SMS
- GPS receiver on board
- Variety wireless communication options
- Wide Range DC input from 6~36V
- Compliant with IP54
- Certified by CE/ FCC/ e13 Mark

VMC 1000, a 7-inch all in one vehicle computer, is designed for the transportation application. Adopting the latest low power consumption processor, Intel® Atom™ E640, it integrates the high resolution LCD with the brightness of 400 nits and 4-wire resistive touch sensor.

VMC 1000 does not compromise with its space to scarify its functional features. It provides RS-232/422/485, USB 2.0, GPIO and LAN signal via DB37 connector to secure the cable simultaneously in the vehicle vibration. Its mounting hole is compatible with VESA75 and can be installed in the vehicle with limited space via RAM mount kits.

## Hardware Specifications

### Main Chipset

- Intel® EG20T

### CPU

- Intel® Atom™ E640 1.0GHz

### Memory

- On board 1GB DDR2 800MHz

### Expansion

- Mini PCIe socket (USB) x 1 (for 3.5G module)
- 1 x GPS module
- Mini PCIe socket (PCIe + USB + SATA) x 1 (for WLAN module)

### I/O Interfaces - Front

- On Screen Display Buttons x 5 Power On/ Off Volume Control (+/-) Brightness Control (+/-)
- Light Sensor
- 2 x LED indicators
- 2 x Built-in Speakers (1W)

### I/O Interfaces - Lateral Side

- 1 x Line-in
- 1 x Line-out
- 1 x USB
- 1 x SIM slot
- 1 x Power Button
- 1 x Reset Button

### Bottom Side

- 1 x DB9 male connector (RS-232)
- 1 x DB37 female connector (1x LAN ; 2x USB ; 1x RS232 ; 1 x RS422/485 ; 6 x GPIO ; 1 x CAN)
- 6~36V Wide Range DC power input
- 1 x SMA connector for GPS antenna

### Expandable Storage

- 1 x mSATA

### Power Management

- Selectable boot-up & shut-down voltage for low power protection
- HW design ready for 8-level delay time on/off at user's self configuration
- Power on/off ignition, software detectable
- Supports S3/S4 suspend mode ; wake on RTC/ SMS



## Hardware Specifications

### Dimensions

- 185.4 mm (W) x 141.4 mm (D) x 50.42 mm (H) (7.3" x 5.57" x 1.99")
- 1 Kg (2.20 Lb)

### Construction

- Plastic case with aluminum die casting heatsink
- Compliant with IP54

### Environment

- Operating temperatures:  
Ambient with air:  
-20°C to 50°C
- Storage temperatures: -30°C to 80°C
- Relative humidity: 10% to 90% (Non-condensing)
- Vibration (random): 2g@5~500 Hz
- Vibration  
Operating: MIL-STD-810F, Method 514.5, Category 20, Ground Vehicle – Highway Truck  
Storage: MIL-STD-810F, Method 514.5, Category 24, Integrity Test

- Shock (with SSD)
  - Operating: MIL-STD-810F, Method 516.5, Procedure I, Trucks and semi-trailers=20g
  - Crash Hazard: MIL-STD-810F, Method 516.5, Procedure V, Ground equipment=75g

### Certifications

- CE approval
- FCC Class B
- e13 Mark

### Power Management

- Power-on delay time is selectable by BIOS to disable and enable in 10sec / 30sec / 1min / 5min / 10 min / 15min / 30min / 1hr.
- Power-off delay time is selectable by BIOS to disable and enable in 20sec / 1min / 5min / 10min / 30min / 1hr / 6hr / 18hr.
- S4 suspend mode
- Ignition On/Off status detectable by SW
- Low battery status detectable by SW
- Ignition enable/disable is jumper selectable

- Shut down system automatically when the system's internal temperature is over 80C.
- VMC 1000 will automatically shut down 5 minutes after the duration of low battery voltage is over 60 sec. User can detect this situation via software.
- If the ignition is off and the system is still on after 3 minutes, VMC 1000 will shut down automatically.
- If the ignition is off, the user can detect this status via the software.
- If the ignition is turned on again and the power-off delay is in progress, VMC 1000 will cancel the delay function and will continue to operate normally.
- If the ignition is turned on again and the power-off delay ended, VMC 1000 will shut down completely will power-on again automatically.
- If the ignition is turned off again and power-on delay is in progress, VMC 1000 will cancel the delay and stay in power-off status.
- If the ignition is turned off again and the power-on delay ended (in BIOS process), VMC 1000 will shut down immediately.
- If VMC 1000 is off, only below 10mA is used.

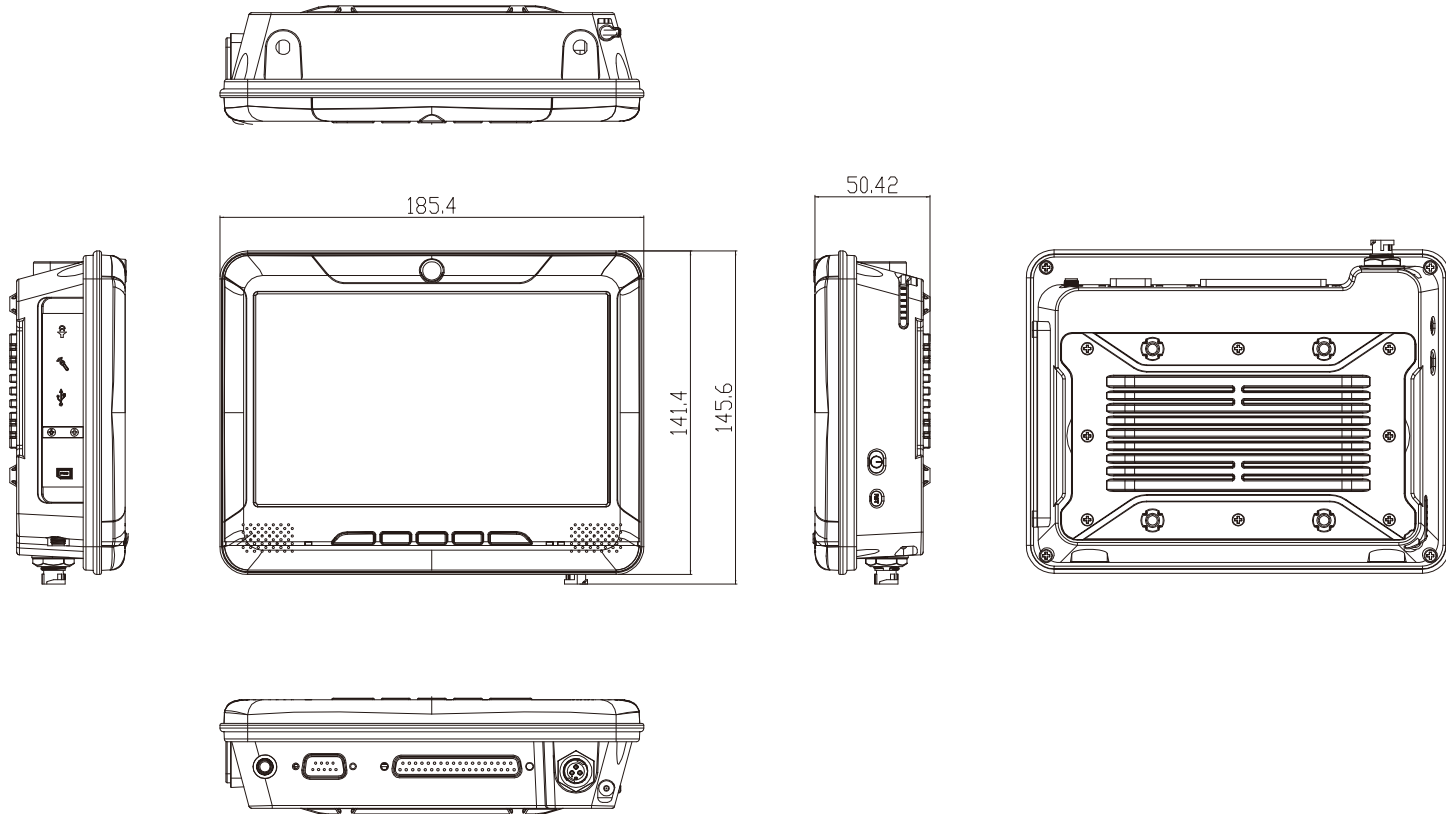

## Getting to Know VMC 1000

### Front View



#### 1.Power On/Off Control

Press this button for 4 seconds -- the monitor will turn on.

#### 2.Brightness Control

There are two modes for Brightness Control: Manual Mode

LCD brightness can be adjusted in 4 levels using the "+" or "-" buttons.

#### Auto Mode

The built-in light sensor will detect environmental brightness and adjust LCD brightness automatically.

#### Switching between Manual Mode and Auto Mode

To toggle between Manual Mode and Auto Mode, press and hold the "+" or "-" buttons for 4 seconds.

#### 3.Volume Control

Audio volume can be adjusted in 8 levels using the buttons.

#### 4.LED

PWR LED is turned on when VMD 1000 is powered on.

Mode LED is turned on when brightness control is in Auto Mode

#### 5.Light Sensor

#### 6.HSDPA Module Antenna Mounting Hole

#### 7.WIFI Module Antenna Mounting Hole

## Rear View



**1. GPS antenna mounting.**

**2. RS-232 Connector (DB9)**

**3. DB37 female connector (1x LAN ; 2x USB ; 1x RS232 ; 1 x RS422/485 ; 6 x GPIO ; 1x CAN)**

**4. 6~36V Wide Range DC power input**

## Getting to Know VMC 1000

### Lateral Side



1.SIM slot

2.USB 2.0/1.1

3.Mic-in

4.Line-out

Another side is power button and reset button3.Volume Control

# Getting to Know VMC 1000

## GPS Connector

Connector location: **CN6**

Connector size: GPS SMA Connector 5 Pin

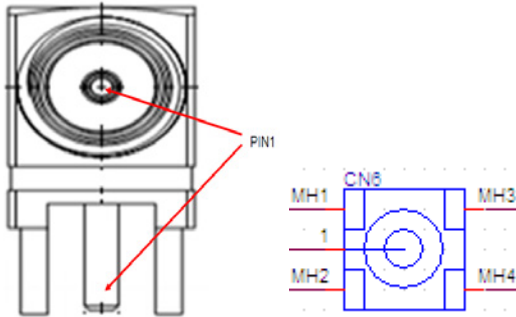

Pin	Definition
1	RF_IN_F
MH1	GND
MH2	GND
MH3	GND
MH4	GND

## RS232 Connector

Connector location: **CN10**

Connector size: Male DSUB-9 PIN

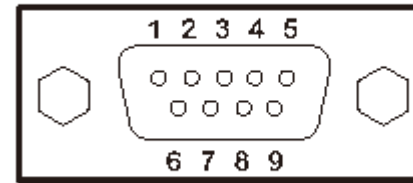

Pin	Definition
1	SP_DCD_0
2	SP_RXD_0
3	SP_TXD_0
4	SP_DTR_0
5	CON0_GND
6	SP_DSR_0
7	SP_RTS_0
8	SP_CTS_0
9	SP_RL_0

## DB37 PIN Connector

Connector location: CN9

Connector size: Female DB37 PIN Connector

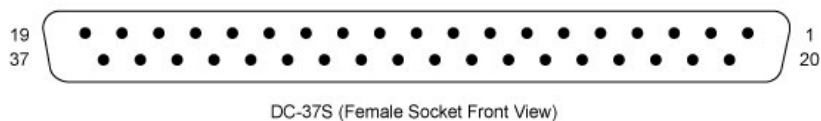

Pin	Definition	Pin	Definition
1	LAN_M0P	20	LAN_M0N
2	LAN_M1P	21	LAN_M1N
3	LAN_M2P	22	LAN_M2N
4	LAN_M3P	23	LAN_M3N
5	L_GND	24	G_OUT1
6	G_IN1	25	G_OUT2
7	G_IN2	26	G_OUT3
8	G_IN3	27	USB_VCC5
9	USB_VCC5	28	HUSB_6N_R
10	HUSB_6P_R	29	HUSB_7N_R
11	HUSB_7P_R	30	RS422_TX+
12	U_GND	31	RS422_TX-
13	RS422_RX+ / RS485_+	32	CANH
14	RS422_RX- / RS485_-	33	CANL
15	SP_RI_1	34	C_GND
16	SP_DCD_1	35	SP_RXD_1
17	SP_TXD_1	36	SP_RTS_1
18	SP_CTS_1	37	SP_DSR_1
19	SP_DTR_1		



## DC Power connector

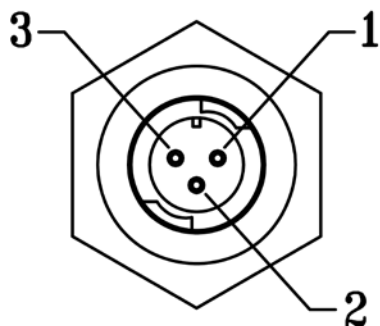

Pin	Definition
1	V_IN 6~36V
2	IGNITION
3	GND

## DC Power cable connector

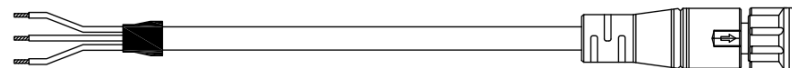

Pin color	Definition
YEL, HT	Solder together for V_IN
BLK	GND

## SIM Card Reader Connector

Connector location: CN5

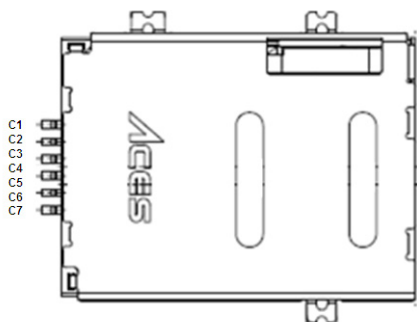

Pin	Definition
C1	UIM_PWR2
C2	UIM_RST2
C3	UIM_CLK2
C5	GND
C6	NC
C7	UIM_DAT2

## USB Connector

Connector location: USB1

Connector size: Single USB 4Pin



Pin	Definition
1	VCC
2	DATA-( USB_ON)
3	DATA+( USB_OP)
4	GND

## Mic-in Jack

**Connector location: CN7**

Connector size: EAR PHONE JACK PINK



Pin	Definition
1	FRONT_OUT_RC
2	LINE_OUTD
3	NC
4	FRONT_OUT_LC
5	ACON_GND
6	ACON_GND

## Line-out Jack

**Connector location: CN8**

Connector size: EAR PHONE JACK GREEN



Pin	Definition
1	NC
2	MIC_JD
3	NC
4	MIC_OUT-L
5	ACON_GND
6	ACON_GND

# Chapter 2: Jumpers and Connectors

This chapter describes how to set the jumpers on the motherboard. Note that the following procedures are generic for all VTC 1000 series.

## Before You Begin

- Ensure you have a stable, clean working environment. Dust and dirt can get into components and cause a malfunction. Use containers to keep small components separated.
- Adequate lighting and proper tools can prevent you from accidentally damaging the internal components. Most of the procedures that follow require only a few simple tools, including the following:
  - A Philips screwdriver
  - A flat-tipped screwdriver
  - A set of jewelers Screwdrivers
  - A grounding strap
  - An anti-static pad
- Using your fingers can disconnect most of the connections. It is recommended that you do not use needle-nosed pliers to disconnect connections as these can damage the soft metal or plastic parts of the connectors.
- Before working on internal components, make sure that the power is off. Ground yourself before touching any internal components, by touching a metal object. Static electricity can damage many of the electronic com-

ponents. Humid environment tend to have less static electricity than dry environments. A grounding strap is warranted whenever danger of static electricity exists.

## Precautions

Computer components and electronic circuit boards can be damaged by discharges of static electricity. Working on the computers that are still connected to a power supply can be extremely dangerous.

Follow the guidelines below to avoid damage to your computer or yourself:

- Always disconnect the unit from the power outlet whenever you are working inside the case.
- If possible, wear a grounded wrist strap when you are working inside the computer case. Alternatively, discharge any static electricity by touching the bare metal chassis of the unit case, or the bare metal body of any other grounded appliance.
- Hold electronic circuit boards by the edges only. Do not touch the components on the board unless it is necessary to do so. Don't flex or stress the circuit board.
- Leave all components inside the static-proof packaging that they shipped with until they are ready for installation.
- Use correct screws and do not over tighten screws.

## Jumper

A jumper is the simplest kind of electric switch. It consists of two metal pins and a cap. When setting the jumpers, ensure that the jumper caps are placed on the correct pins. When the jumper cap is placed on both pins, the jumper is **short**. If you remove the jumper cap, or place the jumper cap on just one pin, the jumper is **open**.

Refer to the illustrations below for examples of what the 2-pin and 3-pin jumpers look like when they are short (on) and open (off).

Two-Pin Jumpers: Open (Left) and Short (Right)

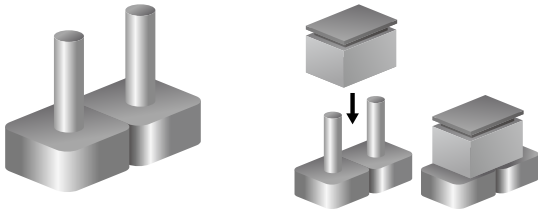

Three-Pin Jumpers: Pins 1 and 2 Are Short

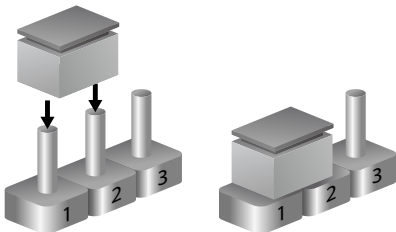

## Locations of the Jumpers and Connectors

The figure below is the main board which is the board used in the VMC 1000 system. It shows the locations of the jumpers and connectors.

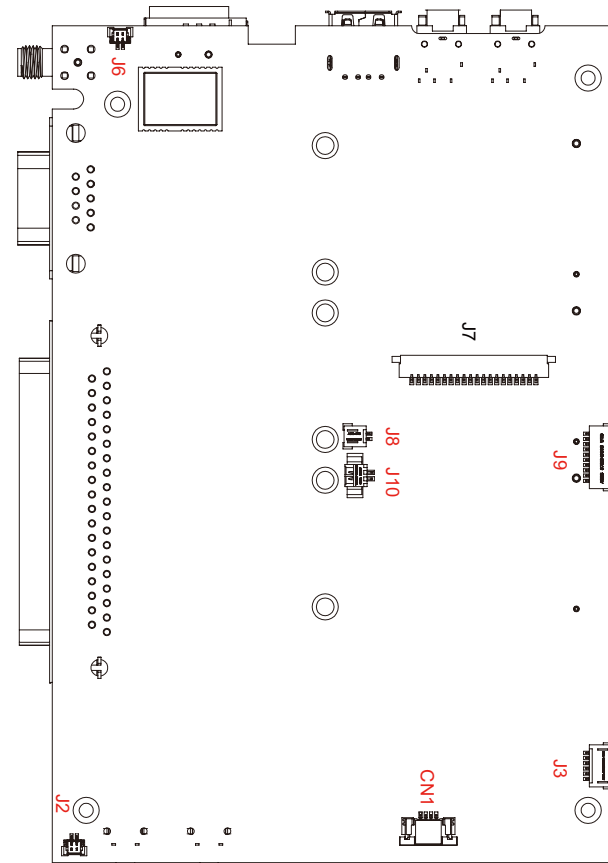
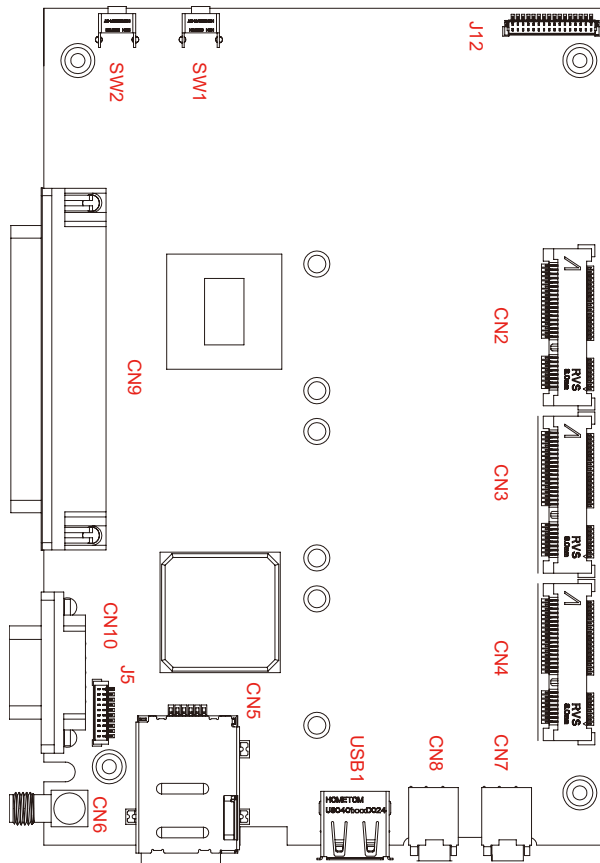

# Internal Connectors and Jumper Settings

## Panel Connector

Connector size: 1.25mm WAFER 20P  
 Connector location: J7

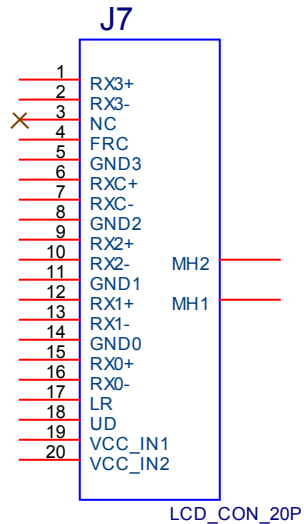
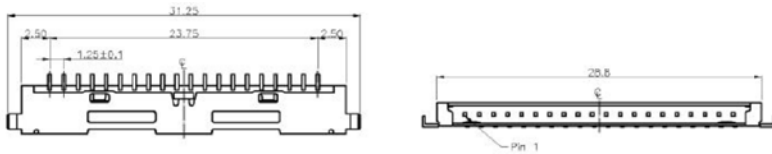

PIN	Definition	PIN	Definition
1	RX3+	11	GND1
2	RX3-	12	RX1+
3	NC	13	RX1-
4	FRC	14	GND0
5	GND3	15	RX0+
6	RXC+	16	RX0-
7	RXC-	17	LR(default:1)
8	GND2	18	UD(default:0)
9	RX2+	19	VCC_IN1
10	RX2-	20	VCC_IN2

### Touch Screen Connector

Connector size: FPC\_1X4P-1mm

Connector location: CN1

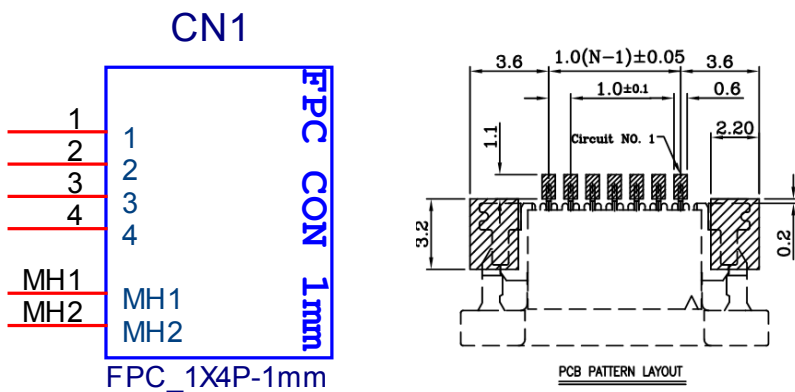

PIN	Definition
1	TOUCH_XL
2	TOUCH_YD
3	TOUCH_XR
4	TOUCH_YU

### Button & Sensor & LED Connector

Connector size: 1mm Wafer 10 Pin180°

Connector location: J5

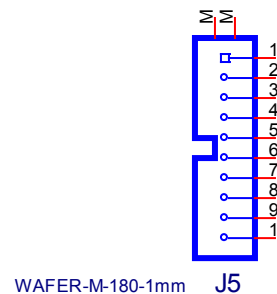

PIN	Definition
1	LS_D
2	LS_A
3	KEY_V+
4	KEY_V-
5	KEY_BL+
6	KEY_BL-
7	BOT_M_N
8	AUTO_BL_LED
9	POWER_LED
10	GND



### Speaker Connector

Connector size: 1mm Wafer 2Pin 180°  
 Connector location: J2, J6

**J2** WAFER-M-90-1mm

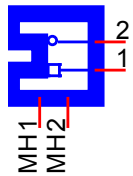

J2	
PIN	Definition
1	FRONT_A_R+_R
2	FRONT_A_R-_R

J6	
PIN	Definition
1	FRONT_A_L+_R
2	FRONT_A_L-_R

### 8051 Download Connector

Connector size: 2.54mm PIN HEADER 5Pin 180°  
 Connector location: JP3, JP5

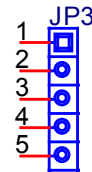

PIN-M-180-2.54mm

JP3	
PIN	Definition
1	+V3.3ALW
2	C2D_1
3	MRST_1
4	C2CK_1
5	GND

JP5	
PIN	Definition
1	+V_MCU2
2	C2D_2
3	MRST_2
4	C2CK_2
5	GND

### RTC Control Connector

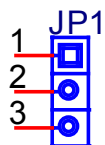

PIN-M-180-2.54mm

JP1	
PIN	Definition
1	RTCRSTN
2	RTC_CLR
3	RTCGND#

### RTC Battery Connector

Connector size: WAFER-M-180-1.25mm

Connector location: J4

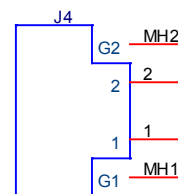

WAFER-M-180-1.25mm

J4	
PIN	Definition
1	GND
2	VBAT1
MH1	GND
MH2	GND

### Backlight Connector(power)

Connector size: 1.25mm Wafer 2 Pin 90°  
 Connector location: J10

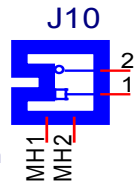

WAFER-M-90-1.25mm

J10	
PIN	Definition
1	GND
2	Panel_backlight

### Backlight Connector(data)

Connector size: 1mm Wafer 2Pin 90°  
 Connector location: J8

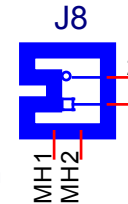

WAFER-M-90-1mm

J8	
PIN	Definition
1	Brightness
2	BK_EN

### CCD Conector

Connector size: 1mm Wafer 6 Pin 90°

Connector location: J3

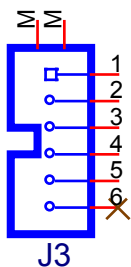

WAFER-M-90-1mm

J3	
PIN	Definition
1	CCD_PWR
2	HUSB_9N
3	HUSB_9P
4	GND
5	CCD_EN_L
6	NC

### PORT 80 Connector

Connector size: 1mm Wafer 10 Pin 90°

Connector location: J9

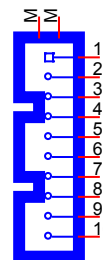

WAFER-M-90-1mm J9

J9	
PIN	Definition
1	VCC3_S
2	VCC3_S
3	LPC_AD0
4	LPC_AD1
5	LPC_AD2
6	LPC_AD3
7	LPC_FRAME#
8	LPC_CLK2
9	SIO_RST#
10	GND

### MINI PCIE Connector

MINI PCIE Connector Interface: M-Sata

Connector location: CN2

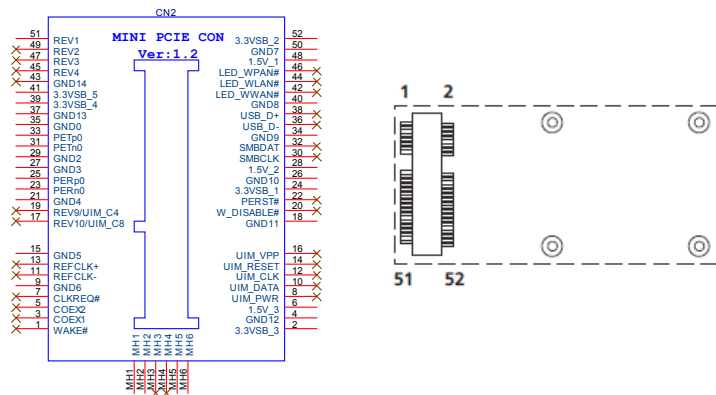

PIN	Definition	PIN	Definition
1	NC	27	GND
2	+3.3C_MINI	28	D15VS
3	NC	29	GND
4	GND	30	NC
5	NC	31	SATA_RXN1
6	D15VS	32	NC
7	NC	33	SATA_RXP1

PIN	Definition	PIN	Definition
8	NC	34	GND
9	GND	35	GND
10	NC	36	NC
11	NC	37	GND
12	NC	38	NC
13	NC	39	+3.3C_MINI
14	NC	40	GND
15	GND	41	+3.3C_MINI
16	NC	42	NC
17	NC	43	NC
18	GND	44	NC
19	NC	45	NC
20	NC	46	NC
21	GND	47	NC
22	NC	48	D15VS
23	SATA_TXP1	49	NC
24	+3.3C_MINI	50	GND
25	SATA_TXN1	51	GND
26	GND	52	+3.3C_MINI

MINI PCIE Connector Interface: Standard Mini-PCI-e/ M-Sata  
Connector location: CN3

PIN	Definition	PIN	Definition
1	PCIE_WAKE#	27	GND
2	+3.3B_MINI	28	D15VS
3	NC	29	GND
4	GND	30	SMB_CLK
5	NC	31	mPCIE_TX_N
6	D15VS	32	SMB_DATA
7	CLKREQ#	33	mPCIE_TX_P
8	NC	34	GND
9	GND	35	GND
10	NC	36	USB_IN
11	MC_PCIE_CLK_N	37	GND
12	NC	38	USB_IP
13	MC_PCIE_CLK_P	39	+3.3B_MINI
14	NC	40	GND
15	GND	41	+3.3B_MINI
16	NC	42	NC
17	NC	43	GND
18	GND	44	LED_WLAN#
19	NC	45	NC

PIN	Definition	PIN	Definition
20	MINICARD1_DIS#	46	NC
21	GND	47	NC
22	WLAN_RESET#	48	D15VS
23	mPCIE_RX_N	49	NC
24	+3.3B_MINI	50	GND
25	mPCIE_RX_P	51	PRE-DEC
26	GND	52	+3.3B_MINI

## MINI PCIE Connector Interface: USB ONLY

Connector location: CN4

PIN	Definition	PIN	Definition
1	NC	27	GND
2	+3.3A_MINI	28	NC
3	NC	29	GND
4	GND	30	NC
5	NC	31	NC
6	NC	32	SMS_RI_3.5G
7	UMTS_GND	33	UMTS_RESET#
8	UIM_PWR2	34	GND
9	GND	35	GND
10	UIM_DAT2	36	USB_3N
11	VCC_MSM26_DIG	37	GND
12	UIM_CLK2	38	USB_3P
13	NC	39	+3.3A_MINI
14	UIM_RST2	40	GND
15	GND	41	+3.3A_MINI
16	NC	42	3.5G_LED#
17	NC	43	GND
18	GND	44	NC
19	NC	45	NC

PIN	Definition	PIN	Definition
20	3.5G_DIS#	46	NC
21	GND	47	NC
22	NC	48	NC
23	NC	49	MINI_RXD_PCMDOUT_NC
24	NC	50	GND
25	NC	51	MINI_TXD_PCMSY_NC
26	GND	52	+3.3A_MINI

### GAL Download Connector

Connector size: 2.54mm PIN HEADER 6Pin 180°  
 Connector location: JP2

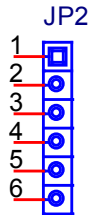

PIN-M-180-2.54mm

PIN	Definition
1	V3P3_G
2	GND
3	TCK
4	TDO
5	TDI
6	TMS

### Input Voltage Control Switch

Connector size: 2x2 DIP SWITCH 180°  
 Connector location: SW3

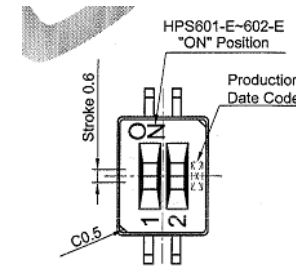
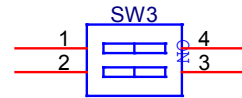

PIN	Definition
1	POWERSW
2	12V24V
3	GND
4	GND



## POWER\_IN Connector

Connector size: 2.5mm Wafer 6 Pin 180°

Connector location: J12

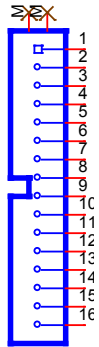

J12

WAFER-M-180-1.0mm

PIN	Definition
1	V_IN
2	V_IN
3	V_IN
4	V_IN
5	V_IN
6	V_IN
7	V_IN
8	IGNITION

PIN	Definition
9	IGNITION
10	V_GND
11	V_GND
12	V_GND
13	V_GND
14	V_GND
15	V_GND
16	V_GND

# Chapter 3: System Setup

## Installing a WLAN module or WWAN module



Prior to removing the chassis cover, make sure the unit's power is off and disconnected from the power sources to prevent electric shock or system damage.

1. Remove these screws and put them in a safe place for later use.

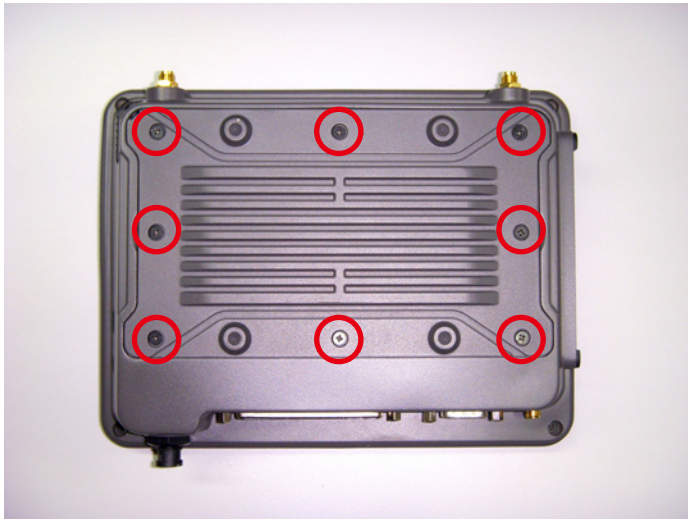

2. Remove the rear cover of the VMC 1000.

The Mini PCI Express slot shown below is used to install a WLAN module or 3.5G communication module such as GPRS, UMTS or HSDPA module.



- For 3.5G module
- For WLAN module
- mSATA

# System Setup

3. Insert the module into the Mini PCI Express slot at a 45 degrees angle until the gold-plated connector on the edge of the module completely disappears inside the slot. And then attach RF cable to the module.
4. Before you install the rear cover, please check the all thermal pads are on the heatsink.

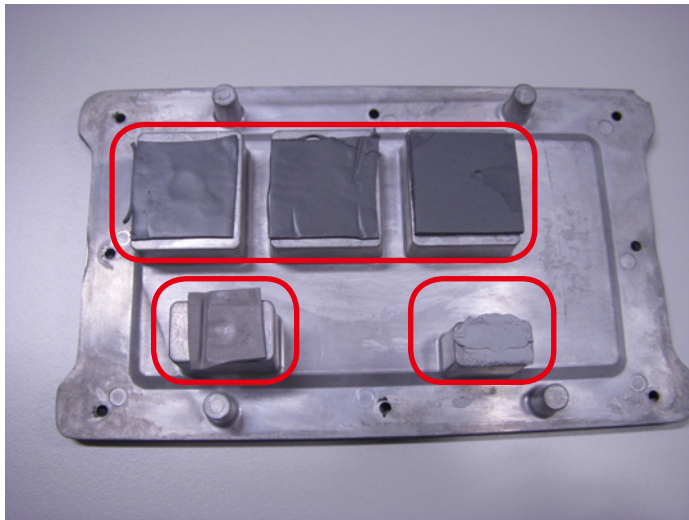

# Appendix A: I/O Address Function

(\*) for default setting

## **GPIO LED / UMTS LED / Ignition Status**

**I/O port : 0EE0H**

<b>Bit</b>	<b>Function Description</b>
Bit 0	GPIO LED (VMC1000 UNUSED) 0: OFF (*) 1: ON
Bit 1	UMTS LED (VMC1000 UNUSED) 0: LED for Wireless (*) 1: LED for 3.5G and Wireless
Bit 2	Ignition (read only) 0: OFF 1: ON
Bit 3	Status of Car Battery 0: Car Battery is OK 1: Car Battery is Low voltage

**WDT**

I/O port : 0EE5H

Bit	Function Description
Bit 3	WDT Disable/Enable 0: Disable (*) 1: Enable

**Bit 2, 1, 0: Time Setting**

Bit 2~0	Time (sec)
000	1 (*)
001	2
010	4
011	8
100	16
101	32
110	64
111	128

Auto clear WDT timer when reading/writing I/O port 0EE5H.

**Onboard Module Disable/Enable(1)**

I/O port : 0EE6H

Bit	Function Description
Bit 0	3.5G module 0: Disable 1: Enable (*)
Bit 1	WLAN module 0: Disable 1: Enable (*)
Bit 2	RESERVED
Bit 3	RESERVED
Bit 4	Wake on 3.5G module 0: Disable 1: Enable (*)
Bit 5	Wake on RTC module 0: Disable 1: Enable (*)

### Delay On Time Setting

I/O port : 0EE7H

Bit7: Power On Delay

0: DISABLE(\*)

1: ENABLE

Bit6: Power Off Delay

0: DISABLE(\*)

1: ENABLE

Bit5~6	Function Description
000	10 sec
001	30 sec
010	1 min
011	5 min
100	10 min
101	15 min
110	30 min
111	1 hour

### Delay Off Time Setting

Bit 2~0	Time (sec)
000	20 sec
001	1 min
010	5 min
011	10 min
100	30 min
101	1 hour
110	6 hour
111	18 hour

### Startup and Shutdown Voltage Control

I/O port : 0EE8H

Only set by switch on motherboard(read only)

Bit3~2	Input Voltage
11	12V
01	24V
10	6~36V
00	6~36V

When input voltage 12V

Bit1~0	Input Voltage 12V
00	Startup Shutdown 11.5V 10.5V
01	Startup Shutdown 12V 11V
10	Startup Shutdown 12.5V 11V
11	Startup Shutdown 12.5V 11.5V

When input voltage 24V

Bit1~0	Input Voltage 24V	
00	Startup 23V	Shutdown 21V
01	Startup 24V	Shutdown 22V
10	Startup 25V	Shutdown 22V
11	Startup 25V	Shutdown 23V

### Setup Command I/O port : 0EE9H

Restart the Setup Command

Enable byte
AA

Using end byte to tell the data flow end

Data	End byte
(Delay time)(Startup/Shutdown voltage setting)	55

### Onboard Module Disable/Enable(1)

I/O port : 0EEAH

Bit	Function Description
Bit 0	Status of RS422/485 MODULE1 0: RS-422 1: RS-485 (*)

### GAL Download control

I/O port : 0EEBH

Restart the Setup Command

Enable byte
AA

### Startup Time Setting

#### I/O port: 0EECH(clock Timer)

Bit0~7: the hour value(binary)

#### I/O port: 0EEDH(clock Timer)

Bit0~7: the minute value(binary)

#### I/O port: 0EEEH( User setting Time)

Bit0~7: the hour value(binary)

#### I/O port: 0EEFH( User setting Time)

Bit0~7: the minute value(binary)



**GPIO****I/O port : 0EE4H, Default Value : 0x38H**

Bit	Function Description
Bit 0-2	GPO 0-2
Bit 3-5	GPI 0-2

# Appendix B: Vehicle Power Management Setup

## External Power Output Setting

External +12V and +5V Turn On Simultaneously

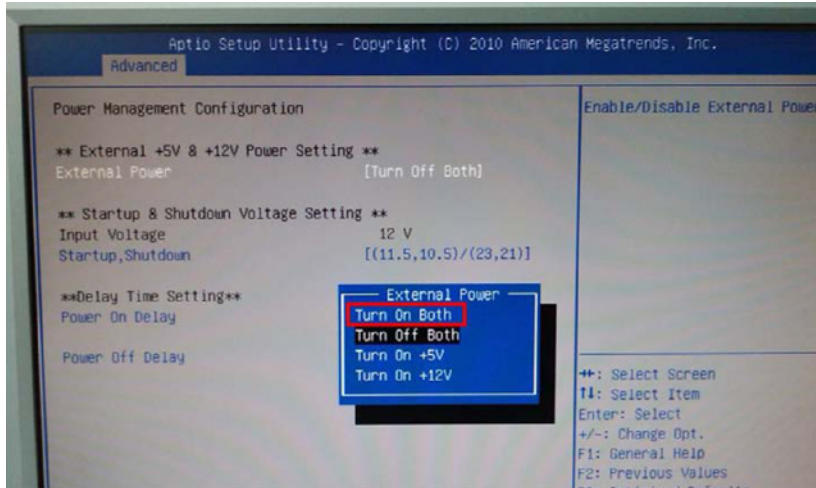

External +12V and +5V Turn Off Simultaneously

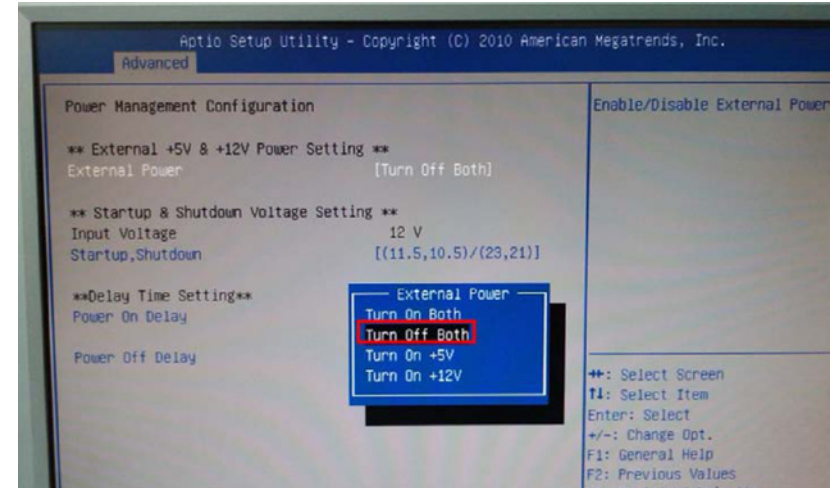

# Vehicle Power Management Setup

## External Power Output Setting

### External +12V Turn On Only

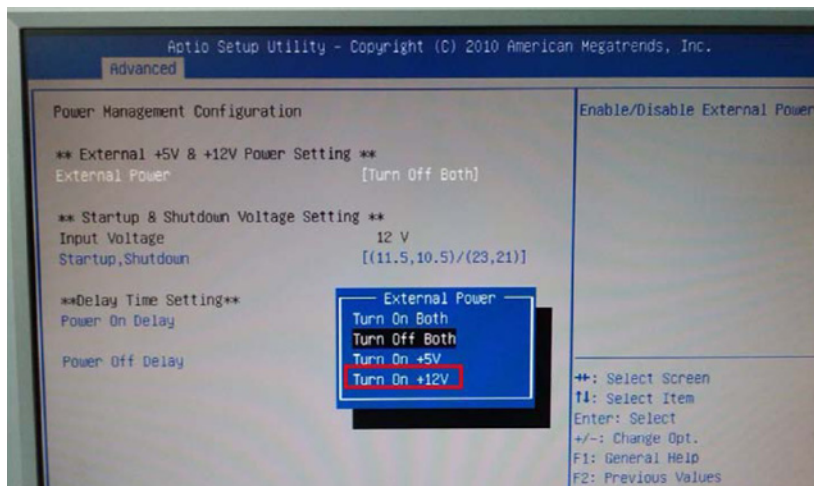

### External +5V Turn On Only

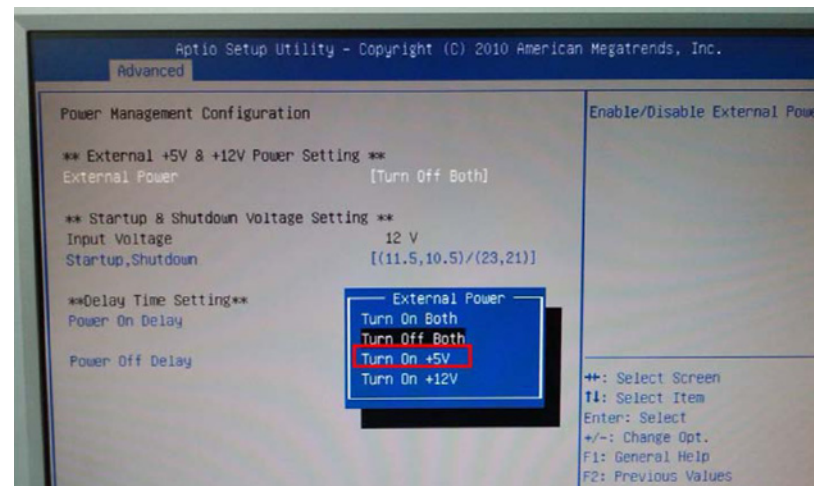

# Vehicle Power Management Setup

## Startup and Shutdown Voltage Setting

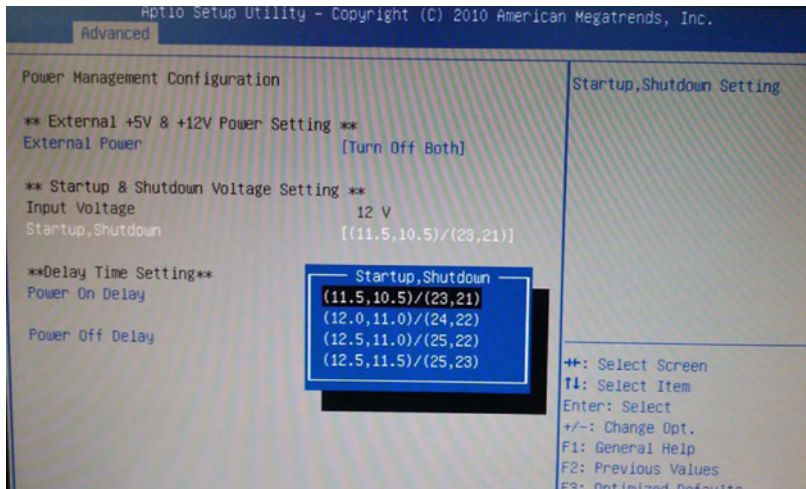

1.

If the input voltage setting is 12V :  
set the startup voltage to 11.5V and the shutdown voltage to 10.5V.

If the input voltage setting is 12V :  
set the startup voltage to 12V and the shutdown voltage to 11V.

If the input voltage setting is 12V :  
set the startup voltage to 12.5V and the shutdown voltage to 11.5V.

If the input voltage setting is 12V :  
set the startup voltage to 12.5V and the shutdown voltage to 11V.

# Vehicle Power Management Setup

## Startup and Shutdown Voltage Setting

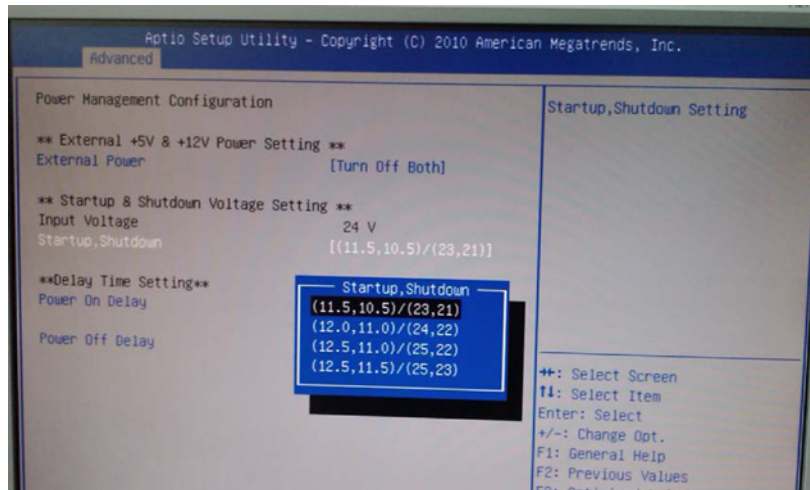

2.

If the input voltage setting is 24V :  
set the startup voltage to 23V and the shutdown voltage to 21V.

If the input voltage setting is 24V :  
set the startup voltage to 24V and the shutdown voltage to 22V.

If the input voltage setting is 24V :  
set the startup voltage to 25V and the shutdown voltage to 22V.

If the input voltage setting is 24V :  
set the startup voltage to 25V and the shutdown voltage to 23V.

# Vehicle Power Management Setup

## Startup and Shutdown Voltage Setting

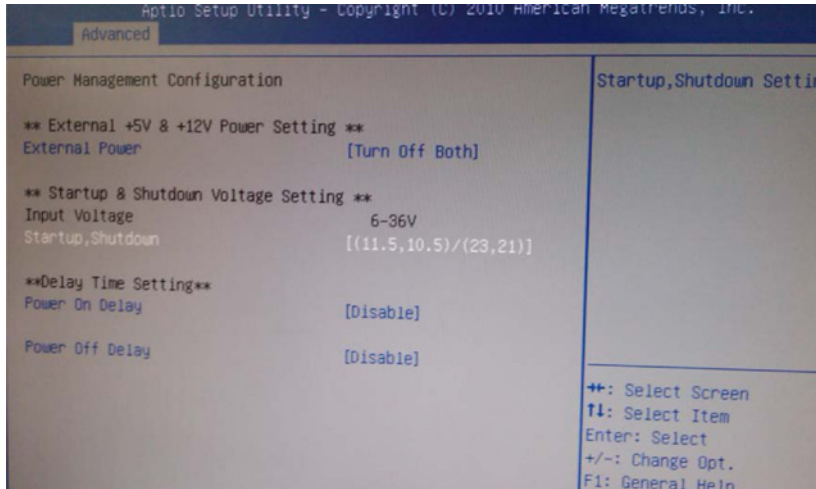

4.

If the input voltage setting is 6v~36V ignore the startup/shutdown setting.

# Vehicle Power Management Setup

## Power-on Delay Setting

### Disable Power-on Delay

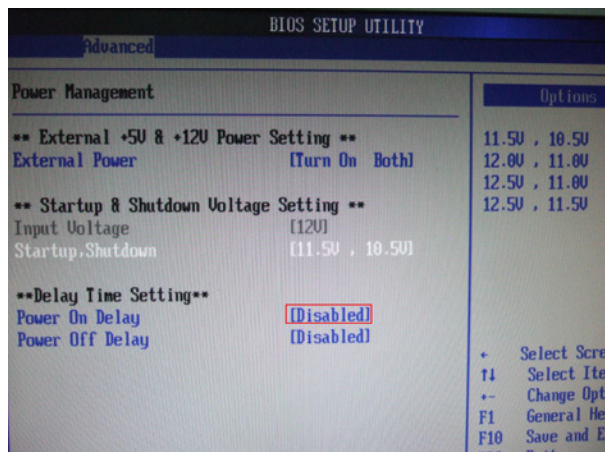

### Enable Power-on Delay

Delay time can be set at 10sec/30sec/1min./5min./10min./15min./30min./1hour.

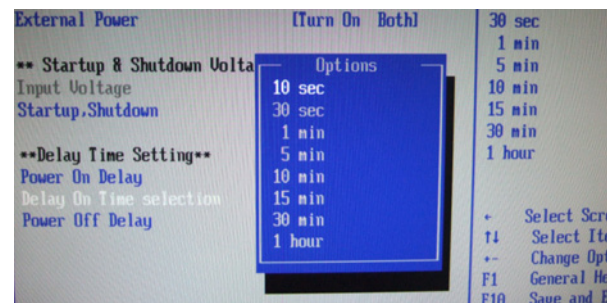
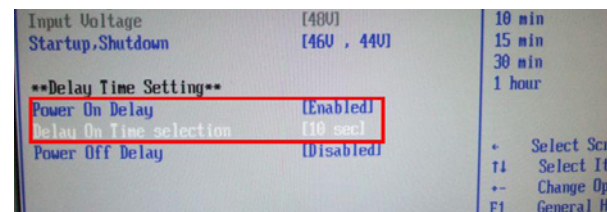

# Vehicle Power Management Setup

## Power-on Delay Setting

### Disable Power-off Delay

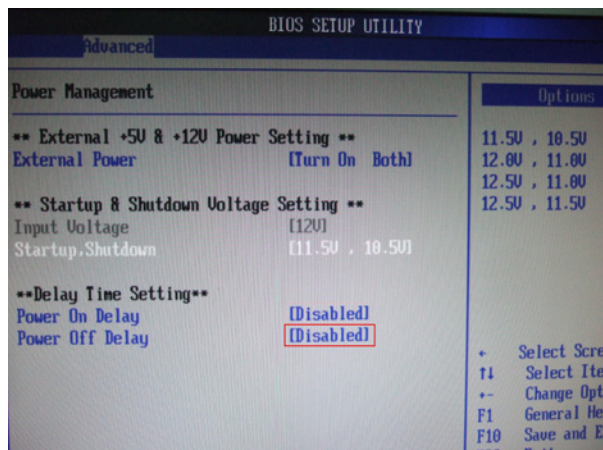

### Enable Power-off Delay

Delay time can be set at 20sec/1min./5min./10min./30min./1hour/6hour/18hour.

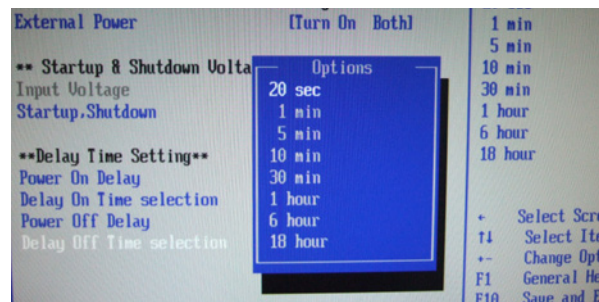
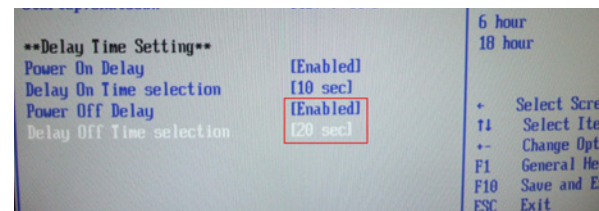



# Appendix C: Power Consumption

## Test Equipment/Tool

DUT#1: VMC1000 with 32GB mSATA

DUT#2: VMC1000 with 32GB mSATA and 3.5G WWAN module

Windows XP

Burn-in Software: Version 5.0

## Test Condition

Room temperature

Power supply graduation: 12V 5A

## Test Procedure:

1. Start of all function at DUT and measure power consumption.
2. Get system into suspend mode and measure power consumption.

Unit	Idle Mode	100% Burn-in Mode	S3	S4	S5
DUT#1	1.3A	1.33A	148mA	12mA	12mA
DUT#2	1.33A	1.35A	72mA	56.7mA	56.7mA

\* Device: N/A

# Appendix D: SMS Wake-up setting

Utilizing sleep mode on the Serra MC8970V 3.5G module and allowing for remote wake up via SMS. (The specification of MC8970V and AT command reference are in the CD-ROM)

Two process to setting the SMS wake-up mode for VTC1000. Please do the following to set it up.

## A. BIOS setting

- (1) Press <Enter> on "BIOS Setting" of the main menu screen.
- (2) Select "Module Management"

- (3) Change the value to "Enable" for "3.5G Module" and "Wake On 3.5G Module"

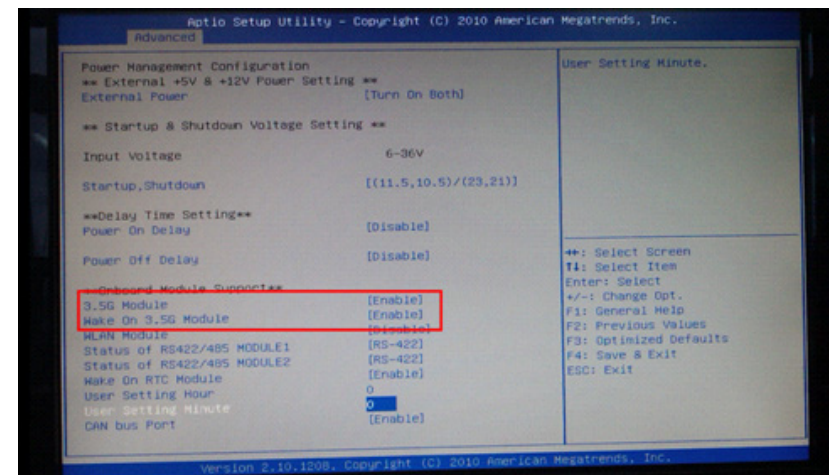
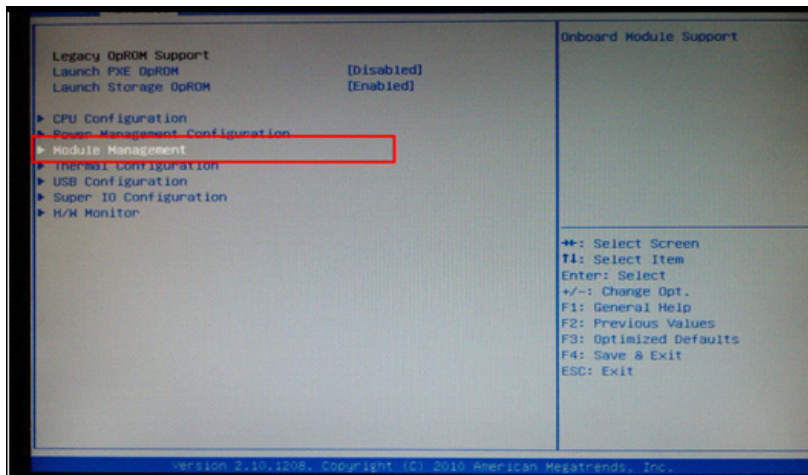

# Appendix D: SMS Wake-up setting

(4) After you have finished with the Setup, press <ESC> to go back to the main menu and then press <Enter> on "Save Changes and Reset".

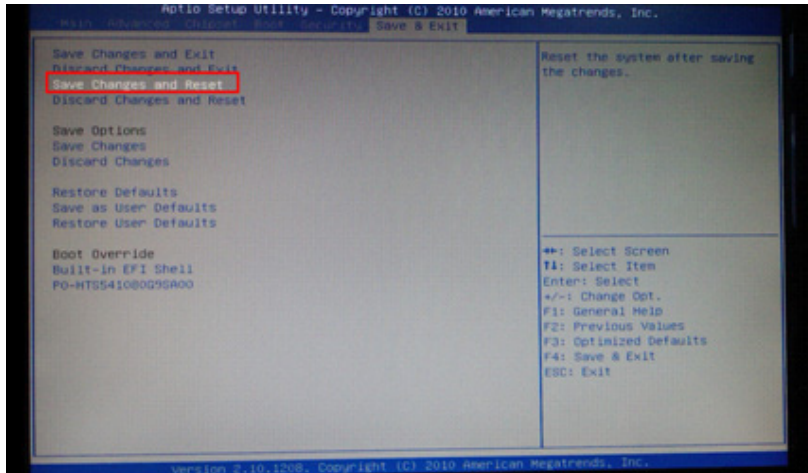

## B. Module setting

- (1) Go into the System applet in the Windows Control Panel, and access "Device Manager"
- (2) In the "Ports (COM & LPT)" section, you will find a port labeled "Sierra Wireless AT Command Port (UMTS)", followed by a COM port number such as COM11.

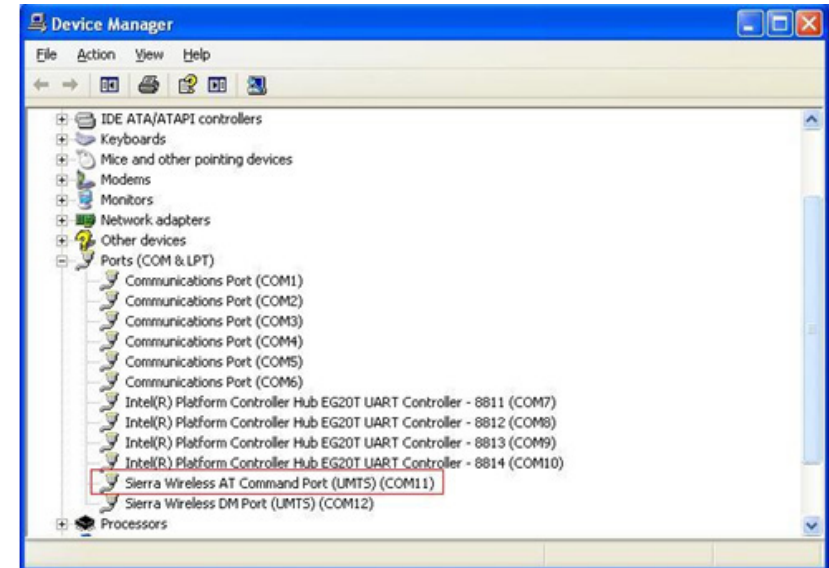

## Appendix D: SMS Wake-up setting

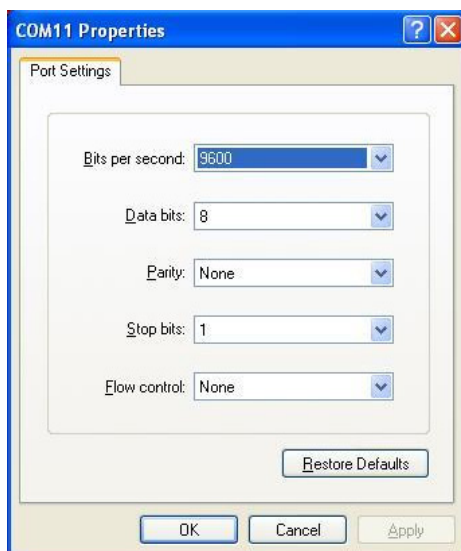

(3) Launch HyperTerminal. (Depending on your version of Windows and how it was installed, you can launch the program by selecting Start -> Programs -> Accessories -> Communications -> HyperTerminal)

(4) Enter any name and select an icon in the Connection Description windows and click "OK".

(5) Select the COM port to which the modem is connected (use **COM11 in this sample**) in the "Connect using" field, and click "OK".

(6) Select these port settings, and click "OK".

## Appendix D: SMS Wake-up setting

(7) Enter the `"at!entercmd="A710"`, and the response would be "OK".

(8) Enter the `"at!mapuart=1"`, and the response would be "OK".

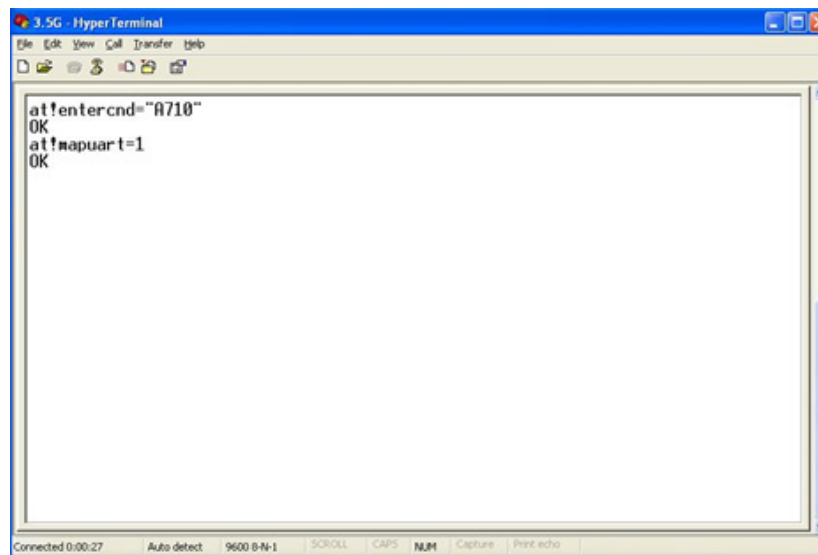

(9) After completed the AT commands, restart your computer.

(10) Repeat the process (3) and (4).

(11) Select the COM port to which the modem is connected (use **COM6**) in the "Connect using" field, and click "OK".

(12) Select these port settings, and click "OK"

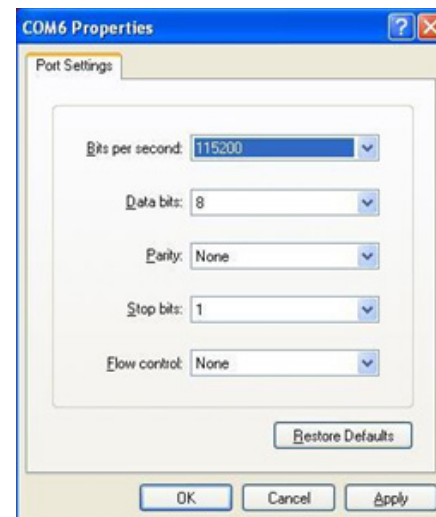

# Appendix D: SMS Wake-up setting

- (13) Enter the **"at!entercmd="A710"**, and the response would be "OK".
- (14) Enter the **"at+wwkup=04"** (to setup wake on SMS), and the response would be "OK".
- (15) Enter the **"at+wwkup?"**, and the response would be "+WWKUP: 04" and "OK". (It mean the setting is completed)

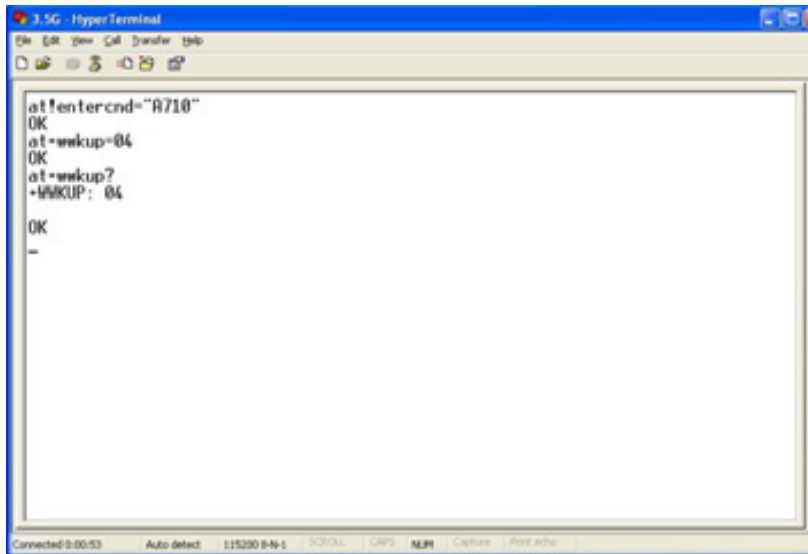

*Note. SMS wake-up function only works in S3, S4 or S5 mode and the ignition off.*

## C. Return the default setting

- (1) Launch HyperTerminal. (Depending on your version of Windows and how it was installed, you can launch the program by selecting Start -> Programs -> Accessories -> Communications -> HyperTerminal)
- (2) Select the COM port to which the modem is connected (use **COM6**) in the "Connect using" field, and click "OK"

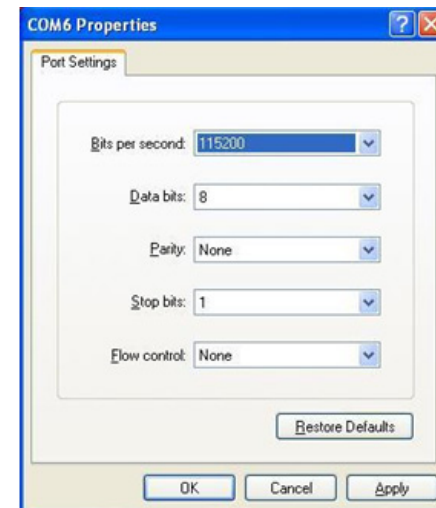

## Appendix D: SMS Wake-up setting

(3) Enter the `"at!entercmd="A710"`, and the response would be "OK".

(5) Restart your computer.

(4) Enter the `"at!mapuart=0"`, and the response would be "OK".

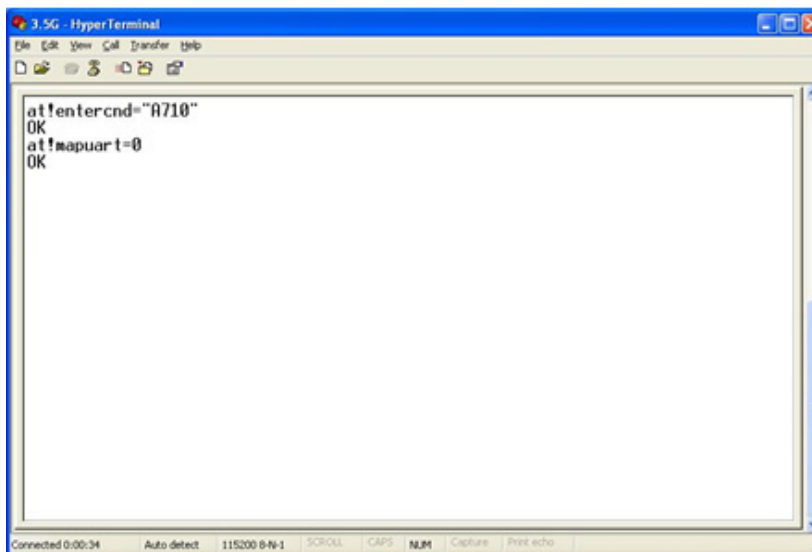

The screenshot shows a HyperTerminal window titled "3.5G - HyperTerminal". The window contains the following text:

```
at!entercmd="A710"  
OK  
at!mapuart=0  
OK
```

The status bar at the bottom of the window displays: "Connected 0:00:34 Auto detect 115200 8-N-1 SCROLL CAPS NUM Capture Print echo".

# Appendix E: RTC Wake-up setting

- (1) Press <Enter> on "BIOS Setting" of the main menu screen.
- (2) Select "Module Management"

- (3) Change the value to "Enable" for "Wake On RTC Module"

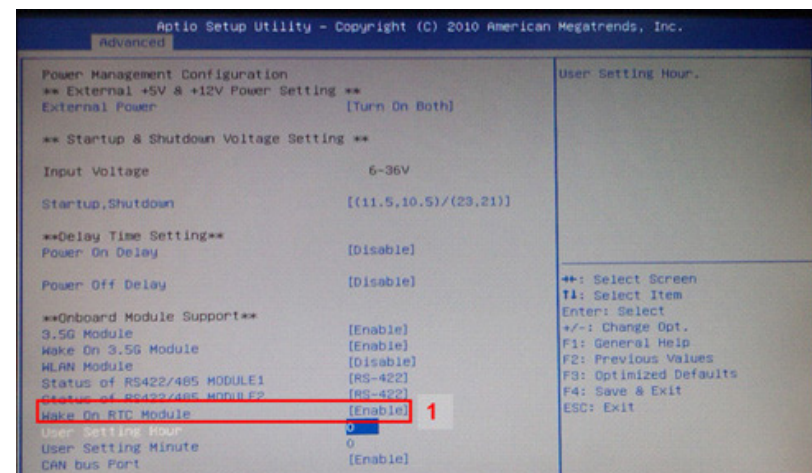
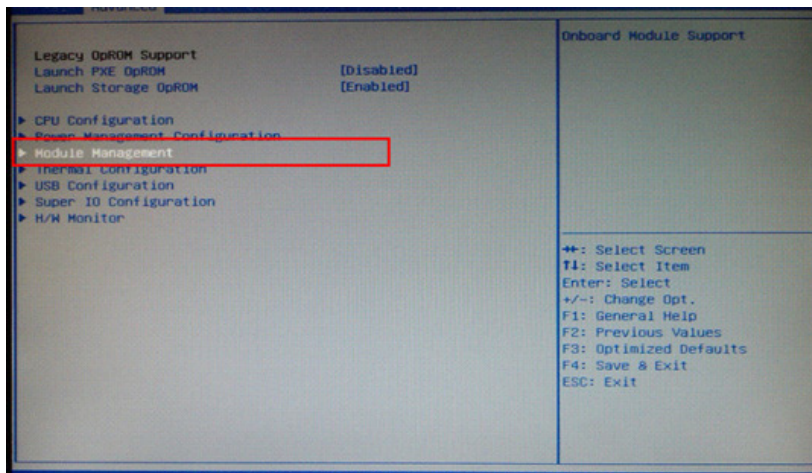



# Appendix E: RTC Wake-up setting

(4) You can key in the value for "User Setting Hour"(0~23) and "User Setting Minute" (0~59)

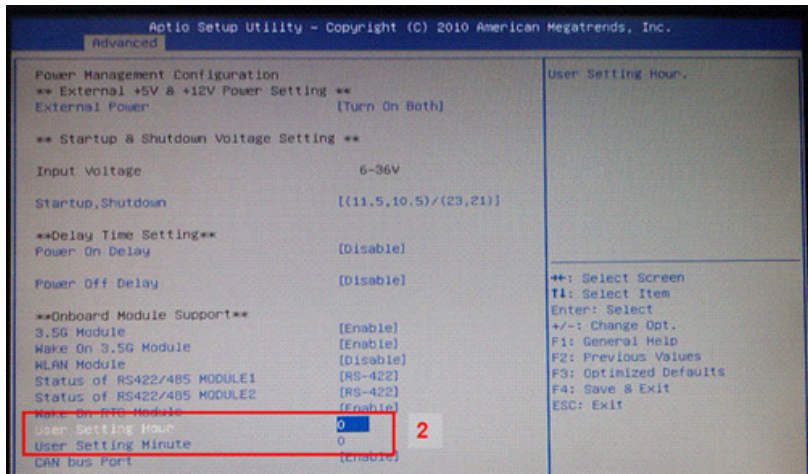

(5) After you have finished with the Setup, press <ESC> to go back to the main menu and then press "Enter" on "Save Changes and Reset"

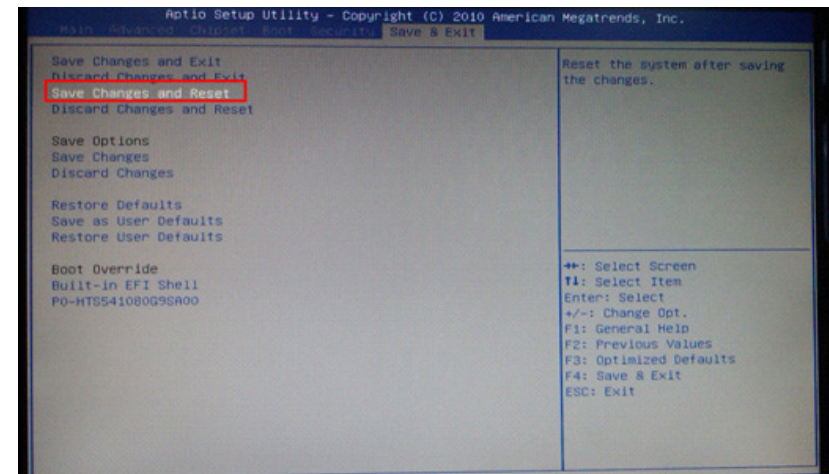

*Note. SMS wake-up function only works in S3, S4 or S5 mode and the ignition off.*