



**NEXCOM International Co., Ltd.**

# **IoT Automation Solutions Business Group**

## **Open Frame Panel PC**

### **OPPC 1540HT-J1900/1940HT-J1900**

#### **User Manual**

# CONTENTS

## Preface

Copyright .....	iv
Disclaimer .....	iv
Acknowledgements .....	iv
Regulatory Compliance Statements .....	iv
Declaration of Conformity .....	iv
RoHS Compliance .....	v
Warranty and RMA .....	vi
Safety Information .....	ix
Installation Recommendations .....	ix
Safety Precautions .....	x
Technical Support and Assistance .....	xi
Conventions Used in this Manual .....	xi
Global Service Contact Information .....	xii
Package Contents .....	xiv
Ordering Information .....	xv

## Chapter 1: Product Introduction

OPPC 1540HT-J1900 .....	1
Specifications .....	2
OPPC 1940HT-J1900 .....	4
Specifications .....	5
Knowing Your OPPC Series .....	7
Rear Bottom .....	7
Rear .....	8

Mechanical Dimensions .....	9
OPPC 1540HT-J1900 .....	9
OPPC 1940HT-J1900 .....	10

## Chapter 2: Jumpers and Connectors

Before You Begin .....	11
Precautions .....	11
Jumper Settings .....	12
Locations of the Jumpers and Connectors .....	13
Top View .....	13
Bottom View .....	14
Jumpers and DIP Switch Settings .....	15
RTC and SRTC Clear Select .....	15
AT/ATX Power Select .....	15
Dimming Signal Level Select .....	16
LCD Panel VDD Power Select .....	16
Touch 4/5 Wire Select .....	17
COM1 RI Pin Power Select .....	17
COM2 RI Pin Power Select .....	18
Panel Resolution Select .....	18
Dimming Type Select .....	19
Connector Pin Definitions .....	20
External I/O Interfaces .....	20
Line-out Connector .....	20
Remote Power On/Off Switch .....	20
LAN1 Port .....	21

LAN2 Port .....	21
Dual USB 2.0 Port .....	22
Single USB 3.0 Port .....	22
COM1 Port .....	23
COM2 Port .....	23
VGA Port .....	24
12V - 30V DC Power Input.....	24
CFast Card Slot .....	25
Reset Button .....	25
Internal Connectors.....	26
CCFL Panel Backlight Connector .....	26
LVDS Channel A.....	26
LVDS Channel B .....	27
Line-in/Mic-in Connector.....	27
Speaker-out Connector .....	28
USB Connector .....	28
Touch Sensor Connector .....	29
SATA Connector.....	29
SATA DOM Power Connector.....	30
DIO Connector (Optional).....	30
Keyboard/Mouse Connector.....	31
Active LED Connector .....	31
Power Button.....	32
Backlight Control Input Connector .....	32
Dimming Control Input Connector .....	33
LVDS MCU FW Debug Connector.....	33
Smart Fan Connector .....	34
Battery Connector .....	34
Post Code Debug Connector.....	35
SIM Card Slot.....	35
Mini-PCIe Slot .....	36
Mini-PCIe Slot (Wi-Fi/3G).....	37
Block Diagram .....	38

## Chapter 3: System Setup

Installing a SATA Hard Drive .....	39
Installing a CFast Card .....	43
Installing a SO-DIMM Memory Module .....	45
Installing a SATA DOM .....	46
Installing a Mini PCIe Module.....	50
Installing the Front Bezel on OPPC 1540HT-J1900 (Optional) .....	54
Installing the Front Bezel on OPPC 1940HT-J1900 (Optional) .....	58
Plugging the DC Power Cable .....	61
Panel Mounting .....	62
Panel Mount Kit (Optional).....	63
Front Bezel Design Guide .....	65
Open Frame Mount .....	66

## Chapter 4: BIOS Setup

About BIOS Setup .....	67
When to Configure the BIOS.....	67
Default Configuration .....	68
Entering Setup .....	68
Legends .....	68
BIOS Setup Utility.....	70
Main .....	70
Advanced .....	71
Chipset.....	79
Security .....	82
Boot.....	82
Save & Exit .....	84

# PREFACE

## Copyright

This publication, including all photographs, illustrations and software, is protected under international copyright laws, with all rights reserved. No part of this manual may be reproduced, copied, translated or transmitted in any form or by any means without the prior written consent from NEXCOM International Co., Ltd.

## Disclaimer

The information in this document is subject to change without prior notice and does not represent commitment from NEXCOM International Co., Ltd. However, users may update their knowledge of any product in use by constantly checking its manual posted on our website: <http://www.nexcom.com>. NEXCOM shall not be liable for direct, indirect, special, incidental, or consequential damages arising out of the use of any product, nor for any infringements upon the rights of third parties, which may result from such use. Any implied warranties of merchantability or fitness for any particular purpose is also disclaimed.

## Acknowledgements

OPPC 1540HT-J1900 and OPPC 1940HT-J1900 are trademarks of NEXCOM International Co., Ltd. All other product names mentioned herein are registered trademarks of their respective owners.

## Regulatory Compliance Statements

This section provides the FCC compliance statement for Class A devices and describes how to keep the system CE compliant.

## Declaration of Conformity

### FCC

This equipment has been tested and verified to comply with the limits for a Class A digital device, pursuant to Part 15 of FCC Rules. These limits are designed to provide reasonable protection against harmful interference when the equipment is operated in a commercial environment. This equipment generates, uses, and can radiate radio frequency energy and, if not installed and used in accordance with the instructions, may cause harmful interference to radio communications. Operation of this equipment in a residential area (domestic environment) is likely to cause harmful interference, in which case the user will be required to correct the interference (take adequate measures) at their own expense.

### CE

The product(s) described in this manual complies with all applicable European Union (CE) directives if it has a CE marking. For computer systems to remain CE compliant, only CE-compliant parts may be used. Maintaining CE compliance also requires proper cable and cabling techniques.

## RoHS Compliance



### **NEXCOM RoHS Environmental Policy and Status Update**

NEXCOM is a global citizen for building the digital infrastructure. We are committed to providing green products and services, which are compliant with European Union RoHS (Restriction on Use of Hazardous Substance in Electronic Equipment) directive 2011/65/EU, to be your trusted green partner and to protect our environment.

RoHS restricts the use of Lead (Pb) < 0.1% or 1,000ppm, Mercury (Hg) < 0.1% or 1,000ppm, Cadmium (Cd) < 0.01% or 100ppm, Hexavalent Chromium (Cr6+) < 0.1% or 1,000ppm, Polybrominated biphenyls (PBB) < 0.1% or 1,000ppm, and Polybrominated diphenyl Ethers (PBDE) < 0.1% or 1,000ppm.

In order to meet the RoHS compliant directives, NEXCOM has established an engineering and manufacturing task force to implement the introduction of green products. The task force will ensure that we follow the standard NEXCOM development procedure and that all the new RoHS components and new manufacturing processes maintain the highest industry quality levels for which NEXCOM are renowned.

The model selection criteria will be based on market demand. Vendors and suppliers will ensure that all designed components will be RoHS compliant.

### **How to recognize NEXCOM RoHS Products?**

For existing products where there are non-RoHS and RoHS versions, the suffix "(LF)" will be added to the compliant product name.

All new product models launched after January 2013 will be RoHS compliant. They will use the usual NEXCOM naming convention.

## Warranty and RMA

### NEXCOM Warranty Period

1. NEXCOM makes products in accordance with the Industry standard and, NEXCOM warrants that all her Industry-grade IPC and System products will be free from defect in neither material nor workmanship for twenty-four (24) months from the day of invoice issued.
2. For NEXCOM Panel PC product lines (the APPC, MPPC series), they are also guaranteed against defect in materials and workmanship for the period of twenty-four (24) months in their motherboard design. For 3rd party parts, it follows with original suppliers' standard: 12 months for battery pack and LCD, 24 months for adaptor / add on modules (including GSM module, RFID module, and antenna).
3. If NEXCOM determines customer's warranty claim is valid, NEXCOM will repair or replace product(s) without additional charge for parts and labor. An extended Warranty Program will extend the warranty period of the product accordingly.

### Warranty Coverage

The warranty applies only to products manufactured or distributed by NEXCOM and her subsidiaries. This warranty covers all the products/shipments except for:

1. Any claimed defect, products that have been repaired or modified by persons who have not been authorized by NEXCOM or, products which have been subjected to misuse, abuse, accident, improper installation, or usage not in accordance with the product instruction. NEXCOM assumes no liability as a consequence of such events under the term of this warranty.

One example is the replacement of Tablet's or Hand-held's LCD display due to scratching stains or other degradation; these will not be covered under this warranty.

2. Damages caused by customers' delivery/shipping of the product or, product failure resulted from electrical power/voltage shock, or, installation of parts/components which are not supplied/approved by NEXCOM in advance.
3. Third-party products:
  - a. Software, such as the device drivers,
  - b. External devices such as HDD, printer, scanner, mouse, LCD panel, battery, and so on,
  - c. Accessory/parts that were not approved by NEXCOM and,
  - d. Accessory/parts were added to products after they were shipped from NEXCOM.

Product will be treated as "Out of Warranty " if:

- a. It expires the warranted 24 months period from the day it was purchased.
- b. It had been altered by persons other than an authorized NEXCOM service person or, which have been subjected to misuse, abuse, accident, or improper installation.
- c. It doesn't have the original NEXCOM Serial Number labeling for NEXCOM's warranty period identification or, tracking.

RMA that NEXCOM has determined not to be covered by the warranty will be charged the NEXCOM Standard Repair Fee for the repairing. If a RMA is determined to be not repairable, customer will be notified and product(s) may be returned to customer at their request; a minimum service fee may be charged however.

### **NEXCOM Return Merchandise Authorization (RMA) Procedure**

For the RMA (Return Merchandise Authorization) shipment, customer is responsible for packaging and shipping the product to the designated NEXCOM service sites, with shipping charges prepaid by the customer. The original NEXCOM shipping box should be used whenever possible. NEXCOM shall pay for the return of the product to the customer's location. In case of expedited shipping request, an extra service charge shall be assessed and the customer is responsible for this extra return shipping charge.

1. Customers should enclose the "NEXCOM RMA Service Form" with the returned products.
2. Customers need to write down all the information related to the problem on the " NEXCOM RMA Service Form " when applying for the RMA service; information will help to understand the problem, including the fault description, on-screen messages, and pictures if possible.
3. Customers could send back the faulty product with or without the accessories and key parts such as the CPU and DIMM. If the key parts are included, please be noted clearly within the return form. NEXCOM takes no responsibility for the parts which are not listed in the return form.
4. Customers hold the responsibility to ensure that the packing of defective products is durable enough to be resistant against further damage due to the transportation; damage caused by transportation is treated as " Out of Warranty " under our Warranty specification.
5. RMA product(s) returned by NEXCOM to any location other than the

customer registered delivery address will incur an extra shipping charge, the customer is responsible for paying the extra shipping charges, duties, and taxes of this shipment.

### **Product Repairing**

1. NEXCOM will repair defective products covered under this limited warranty that are returned to NEXCOM; if products do prove to be defective, they will be repaired during their warranty period unless other warranty terms have been specified.
2. NEXCOM owns all parts removed from repaired products.
3. NEXCOM will use parts made by various manufacturers in performing the repair.
4. The repaired products will be warranted subjected to the original warranty coverage and period only.
5. For products returned as defective but, proved to be no defect/fault after the RMA process, NEXCOM reserves the right to claim for a NDF (No Defect Found) Service Charge.
6. NEXCOM will issue RMA Report which included Repair Detailed Information to the customer when the defective products were repaired and returned.
7. In addition to the above, NEXCOM may authorize Independent/Third-party suppliers to repair the defective products for NEXCOM.

## Out Of Warranty Service

There will be a service charge from NEXCOM for the “Out Of Warranty” product service; they are the Basic Diagnostic Service Fee and the Advanced Component Replacement Fee respectively. And, if the product can not be repaired, NEXCOM will either return the product to the customer or, just scrap it, followed by customer’s instruction.

### 1. Testing and Parts Replacement

NEXCOM will have the following Handling Charges for those OoW products that returned:

- a. Basic Labor Cost and Testing Fee: as Table listed.
  - b. Parts Fee: NEXCOM will charge for main IC chipsets such as the N.B., S.B., Super-IO, LAN, Sound, Memory, and so on.
  - c. 3rd-party Device Fee: products replacement for CPU, DIMM, HDD, Chassis, and UPS.
2. Out of Warranty product will have a three months warranty for the fixed issues. If the product failed with different problem within 3 months, they will still incur the service charge of “Out of Warranty”.
3. Out of Warranty “products will not be repaired without a signed PI from the customer, the agreement of the repair process.

Add-on card, 3rd Party Device and board level repair cost higher than new product prices, customer can abandon to sign PI to repair and, please contact with sales to buy new products.



## Safety Information

Before installing and using the device, note the following precautions:

- Read all instructions carefully.
- Do not place the unit on an unstable surface, cart, or stand.
- Follow all warnings and cautions in this manual.
- When replacing parts, ensure that your service technician uses parts specified by the manufacturer.
- Avoid using the system near water, in direct sunlight, or near a heating device.
- The load of the system unit does not solely rely for support from the rackmounts located on the sides. Firm support from the bottom is highly necessary in order to provide balance stability.
- The computer is provided with a battery-powered real-time clock circuit. There is a danger of explosion if battery is incorrectly replaced. Replace only with the same or equivalent type recommended by the manufacturer. Discard used batteries according to the manufacturer's instructions.

## Installation Recommendations

Ensure you have a stable, clean working environment. Dust and dirt can get into components and cause a malfunction. Use containers to keep small components separated.

Adequate lighting and proper tools can prevent you from accidentally damaging the internal components. Most of the procedures that follow require only a few simple tools, including the following:

- A Philips screwdriver
- A flat-tipped screwdriver
- A grounding strap
- An anti-static pad

Using your fingers can disconnect most of the connections. It is recommended that you do not use needle-nose pliers to disconnect connections as these can damage the soft metal or plastic parts of the connectors.

## Safety Precautions

1. Read these safety instructions carefully.
2. Keep this User Manual for later reference.
3. Disconnect this equipment from any AC outlet before cleaning. Use a damp cloth. Do not use liquid or spray detergents for cleaning.
4. For plug-in equipment, the power outlet socket must be located near the equipment and must be easily accessible.
5. Keep this equipment away from humidity.
6. Put this equipment on a stable surface during installation. Dropping it or letting it fall may cause damage.
7. The openings on the enclosure are for air convection to protect the equipment from overheating. **DO NOT COVER THE OPENINGS.**
8. Make sure the voltage of the power source is correct before connecting the equipment to the power outlet.
9. Place the power cord in a way so that people will not step on it. Do not place anything on top of the power cord. Use a power cord that has been approved for use with the product and that it matches the voltage and current marked on the product's electrical range label. The voltage and current rating of the cord must be greater than the voltage and current rating marked on the product.
10. All cautions and warnings on the equipment should be noted.
11. If the equipment is not used for a long time, disconnect it from the power source to avoid damage by transient overvoltage.
12. Never pour any liquid into an opening. This may cause fire or electrical shock.
13. Never open the equipment. For safety reasons, the equipment should be opened only by qualified service personnel.
14. If one of the following situations arises, get the equipment checked by service personnel:
  - a. The power cord or plug is damaged.
  - b. Liquid has penetrated into the equipment.
  - c. The equipment has been exposed to moisture.
  - d. The equipment does not work well, or you cannot get it to work according to the user's manual.
  - e. The equipment has been dropped and damaged.
  - f. The equipment has obvious signs of breakage.
15. Do not place heavy objects on the equipment.
16. The unit uses a three-wire ground cable which is equipped with a third pin to ground the unit and prevent electric shock. Do not defeat the purpose of this pin. If your outlet does not support this kind of plug, contact your electrician to replace your obsolete outlet.
17. **CAUTION: DANGER OF EXPLOSION IF BATTERY IS INCORRECTLY REPLACED. REPLACE ONLY WITH THE SAME OR EQUIVALENT TYPE RECOMMENDED BY THE MANUFACTURER. DISCARD USED BATTERIES ACCORDING TO THE MANUFACTURER'S INSTRUCTIONS.**

## Technical Support and Assistance

1. For the most updated information of NEXCOM products, visit NEXCOM's website at [www.nexcom.com](http://www.nexcom.com).
2. For technical issues that require contacting our technical support team or sales representative, please have the following information ready before calling:
  - Product name and serial number
  - Detailed information of the peripheral devices
  - Detailed information of the installed software (operating system, version, application software, etc.)
  - A complete description of the problem
  - The exact wordings of the error messages

### Warning!

1. Handling the unit: carry the unit with both hands and handle it with care.
2. Maintenance: to keep the unit clean, use only approved cleaning products or clean with a dry cloth.
3. CFast: Turn off the unit's power before inserting or removing a CFast storage card.

## Conventions Used in this Manual



### Warning:

Information about certain situations, which if not observed, can cause personal injury. This will prevent injury to yourself when performing a task.



### Caution:

Information to avoid damaging components or losing data.



### Note:

Provides additional information to complete a task easily.

## Global Service Contact Information

### Headquarters

#### **NEXCOM International Co., Ltd.**

9F, No. 920, Chung-Cheng Rd.,  
ZhongHe District, New Taipei City, 23586,  
Taiwan, R.O.C.

Tel: +886-2-8226-7786

Fax: +886-2-8226-7782

[www.nexcom.com](http://www.nexcom.com)

### America

#### **USA**

#### **NEXCOM USA**

2883 Bayview Drive,  
Fremont CA 94538, USA

Tel: +1-510-656-2248

Fax: +1-510-656-2158

Email: [sales@nexcom.com](mailto:sales@nexcom.com)

[www.nexcom.com](http://www.nexcom.com)

### Asia

#### **Taiwan**

#### **NEXCOM Intelligent Systems**

#### **Taipei Office**

13F, No.920, Chung-Cheng Rd.,  
ZhongHe District,  
New Taipei City, 23586, Taiwan, R.O.C.

Tel: +886-2-8226-7796

Fax: +886-2-8226-7792

Email: [sales@nexcom.com.tw](mailto:sales@nexcom.com.tw)

[www.nexcom.com.tw](http://www.nexcom.com.tw)

### **NEXCOM Intelligent Systems**

#### **Taichung Office**

16F, No.250, Sec. 2, Chongde Rd.,  
Beitun Dist.,

Taichung City 406, R.O.C.

Tel: +886-4-2249-1179

Fax: +886-4-2249-1172

Email: [sales@nexcom.com.tw](mailto:sales@nexcom.com.tw)

[www.nexcom.com.tw](http://www.nexcom.com.tw)

### **Japan**

#### **NEXCOM Japan**

9F, Tamachi Hara Bldg.,  
4-11-5, Shiba Minato-ku,  
Tokyo, 108-0014, Japan

Tel: +81-3-5419-7830

Fax: +81-3-5419-7832

Email: [sales@nexcom-jp.com](mailto:sales@nexcom-jp.com)

[www.nexcom-jp.com](http://www.nexcom-jp.com)

### **China**

#### **NEXCOM China**

Floor 5, No.4, No.7 fengxian middle Rd.,  
(Beike Industrial Park), Haidian District,  
Beijing, 100094, China

Tel: +86-10-5704-2680

Fax: +86-10-5704-2681

Email: [sales@nexcom.cn](mailto:sales@nexcom.cn)

[www.nexcom.cn](http://www.nexcom.cn)

## **NEXCOM Shanghai**

Room 603/604, Huiyinmingzun Plaza Bldg., 1,  
No.609, Yunlin East Rd.,  
Shanghai, 200333, China  
Tel: +86-21-5278-5868  
Fax: +86-21-3251-6358  
Email: sales@nexcom.cn  
www.nexcom.cn

## **NEXCOM Surveillance Technology Corp.**

Room202, Building B,  
the GuangMing Industrial Zone Zhonghua Rd.,  
Minzhi Street, Longhua District,  
Shenzhen 518131, China  
Tel: +86-755-8364-7768  
Fax: +86-755-8364-7738  
Email: steveyang@nexcom.com.tw  
www.nexcom.cn

## **NEXCOM United System Service**

Hui Yin Ming Zun Building Room 1108,  
Building No. 11, 599 Yunling Road, Putuo District,  
Shanghai, 200062, China  
Tel: +86-21-6125-8282  
Fax: +86-21-6125-8281  
Email: frankyang@nexcom.cn  
www.nexcom.cn

## **Europe**

### **United Kingdom**

#### **NEXCOM EUROPE**

10 Vincent Avenue,  
Crownhill Business Centre,  
Milton Keynes, Buckinghamshire  
MK8 0AB, United Kingdom  
Tel: +44-1908-267121  
Fax: +44-1908-262042  
Email: sales.uk@nexcom.eu  
www.nexcom.eu

### **Italy**

#### **NEXCOM ITALIA S.r.l**

Via Lanino 42,  
21047 Saronno (VA), Italia  
Tel: +39 02 9628 0333  
Fax: +39 02 9625 570  
Email: nexcomitalia@nexcom.eu  
www.nexcomitalia.it

## Package Contents

Before continuing, verify that the package you received is complete. Your OPPC 1540HT-J1900/1940HT-J1900 package should have all the items listed in the table.

### OPPC 1540HT-J1900

Item	Description	Qty
1	Driver CD	1
2	Flat Head for HDD Installation	4
3	Panel Mount Kit	8

### OPPC 1940HT-J1900

Item	Description	Qty
1	Driver CD	1
2	Flat Head for HDD Installation	4
3	Panel Mount Kit	10



Driver CD



Panel Mount Kit  
(OPPC 1540HT-J1900)



Flat Head Screw



Panel Mount Kit  
(OPPC 1940HT-J1900)



Note: Package contents may vary depending on your country region, some items may be optional. Please contact your local distributor for more information.

## Ordering Information

The following information below provides ordering information for the Open Frame Panel PC series.

### Barebone

- **OPPC 1540HT-J1900 (P/N: 90IQ1540H00X0)**  
15" XGA LED backlight touch Panel PC with Intel® Celeron™ J1900, 2.0GHz, 1000 nits, touch screen, 4GB DDR3L with 2x RS232/422/485
- **OPPC 1940HT-J1900 (P/N: 90IQ1940H00X0)**  
19" SXGA LED backlight touch Panel PC with Intel® Celeron™ J1900, 2.0GHz, 1000 nits, touch screen, 4GB DDR3L with 2x RS232/422/485

### Optional

- **12V, 60W AC/DC power adapter w/o power cord (P/N: 7400060031X00)**

# CHAPTER 1: PRODUCT INTRODUCTION

## OPPC 1540HT-J1900

### Overview



### Key Features

- 4:3 15" XGA Fanless Panel Computer
- Intel® Celeron™ J1900, Quad core, low power consumption
- 1000 nits High brightness
- Flush Panel by 5-wire Touch Screen
- PS2 KB/MS/Line-out/Dual GbE/3x USB
- 2x RS232/422/485/2nd display-VGA/1x Mini-PCIe socket/1x CFast
- Remote power switch
- DDR3L 4GB/2.5" HDD bracket
- Support JMobile HMI, Citect SCADA and CODESYS SoftLogic (optional)
- Mounting support: Panel/Wall/Stand/VESA 100mm x 100mm
- Wide range power input 12V~ 30V DC



## Specifications

### Panel

- LED size: 15", 4:3
- Resolution: XGA 1024x768
- Luminance: 1000cd/m<sup>2</sup>
- Contrast ratio: 2500
- LCD color: 16.2M
- Viewing angle: 88(U), 88(D), 88(L), 88(R)
- Backlight: LED

### Touch Screen

- 5-wire resistive (flush panel type)
- Touch light transmission: 81%
- Touch interface: USB

### System

- CPU: On-board Intel® Celeron™, Quad core processor J1900, 2.0GHz, 2M L2 Cache
- BIOS: AMI BIOS
- System memory: 2x 204-pin DDR3L SO-DIMM socket, 4GB DDR3L (Default), Support up to 8GB DDR3L-1066/1333, Non-ECC and Unbuffered
- Storage device:
  - 1x external locked CFast socket
  - 1x hard drive bay: optional 1x 2.5" SATA HDD or 1x SATA DOM
- Watchdog timer: Watchdog timeout can be programmed by software from 1 second to 255 seconds and from 1 minute to 255 minutes (Tolerance 15% under room temperature 25°C)
- H/W status monitor: monitoring system temperature, and voltage
- Expansion: 2x Mini-PCIe sockets (support optional Wi-Fi, 3.5G module)

### Rear I/O

- PS2 keyboard/mouse
- Audio port: 1x Line-out
- Remote power switch
- Ethernet: 2x RJ45
- USB: 2x USB 2.0; 1x USB 3.0
- COM #1: RS232/422/485
- COM #2: RS232/422/485
- Reset button
- 2nd display VGA port: 1x DB15
- Power switch

### Audio

- AC97 codec: Realtek ALC886-GR
- Audio interface: Line-out/Line-in (Optional)/MIC-in (Optional) audio Jack

### Ethernet

- LAN chip: dual Intel® I210AT Gigabit LAN
- Ethernet interface: 10/100/1000 Based-Tx Ethernet compatible

### Mechanical & Environment

- Mounting: panel/wall/stand/VESA 100mm x 100mm
- Power input: 12V~30V DC
- Power adaptor: Optional AC to DC power adaptor (+12V, 60W)
- Vibration:
  - IEC 68 2-64 (w/ HDD)
  - 1Grms @ sine, 5~500Hz, 1hr/axis (HDD operating)
  - 2Grms @ sine, 5~500Hz, 1hr/axis (CFast operating)
  - 2.2Grms @ random condition, 5~500Hz, 0.5hr/axis (non-operating)

- Shock:
  - IEC 68 2-27
  - HDD: 20G@wall mount, half sine, 11ms
- Operating temperature: -5°C to 50°C
- Storage temperature: -20°C to 75°C
- Operating humidity: 10%~90% relative humidity, non-condensing
- Dimension: 329 x 280 x 69.3mm
- Weight: 4kg

### **Certifications**

- CE approval
- FCC Class A

## OPPC 1940HT-J1900



### Key Features

- 4:3 19" SXGA Fanless Panel Computer
- Intel® Celeron™ J1900, Quad core, low power consumption
- 1000 nits High brightness
- Flush Panel by 5-wire Touch Screen
- PS2 KB/MS/Line-out/Dual GbE/3x USB
- 2x RS232/422/485/2nd display-VGA/1x Mini-PCIe sockets/1x CFast
- Remote power switch
- DDR3L 4GB/2.5" HDD bracket
- Support JMobile HMI, Citect SCADA and CODESYS SoftLogic (optional)
- Mounting support: Panel/Wall/Stand/VESA 100mm x 100mm
- Wide range power input 12V~ 30V DC

## Specifications

### Panel

- LED size: 19", 4:3
- Resolution: SXGA 1280x1024
- Luminance: 1000cd/m<sup>2</sup>
- Contrast ratio: 1000:1
- LCD color: 16.7M
- Viewing angle: 80(U), 80(D), 85(L), 85(R)
- Backlight: LED

### Touch Screen

- 5-wire resistive (flush panel type)
- Touch light transmission: 80%
- Touch interface: USB

### System

- CPU: On-board Intel® Celeron™, Quad core processor J1900, 2.0GHz, 2M L2 Cache
- BIOS: AMI BIOS
- System memory: 2x 204-pin DDR3L SO-DIMM socket, 4GB DDR3L (Default), Support up to 8GB (4GB+4GB) DDR3L-1066/1333, Non-ECC and Un-buffered
- Storage device:
  - 1x external locked CFast socket
  - 1x hard drive bay: optional 1x 2.5" SATA HDD or 1x SATA DOM
- Watchdog timer: Watchdog timeout can be programmed by software from 1 second to 255 seconds and from 1 minute to 255 minutes (Tolerance 15% under room temperature 25°C)
- H/W status monitor: monitoring system temperature, and voltage
- Expansion: 1x Mini-PCIe socket1 (support optional Wi-Fi, 3.5G module)

### Rear I/O

- PS2 keyboard/mouse
- Audio port: 1x Line-out
- Remote power switch
- Ethernet: 2x RJ45
- USB: 2x USB 2.0; 1x USB 3.0
- COM #1: RS232/422/485
- COM #2: RS232/422/485
- Reset button
- 2nd display VGA port: 1x DB15
- Power switch

### Audio

- AC97 codec: Realtek ALC886-GR
- Audio interface: Line-out/Line-in (Optional)/Mic-in (Optional) audio Jack

### Ethernet

- LAN chip: dual Intel® I210AT Gigabit LAN
- Ethernet interface: 10/100/1000 Based-Tx Ethernet compatible

### Mechanical & Environment

- Mounting: panel/wall/stand/VESA 100mm x 100mm
- Power input: 12V~30V DC
- Power adapter: Optional AC to DC power adaptor (+12V, 60W)
- Vibration:
  - IEC 68 2-64 (w/ HDD)
  - 1Grms @ sine, 5~500Hz, 1hr/axis (HDD operating)
  - 2Grms @ sine, 5~500Hz, 1hr/axis (CFast operating)
  - 2.2Grms @ random condition, 5~500Hz, 0.5hr/axis (non-operating)

- Shock:
  - IEC 68 2-27
  - HDD: 20G@wall mount, half sine, 11ms
- Operating temperature: -5°C to 50°C
- Storage temperature: -20°C to 75°C
- Operating humidity: 10%~90% relative humidity, non-condensing
- Dimension: 422.6(W) x 350.6(H) x 73.2(D)mm
- Weight: 6.15Kg

### **Certifications**

- CE approval
- FCC Class A

## Knowing Your OPPC Series

### Rear Bottom

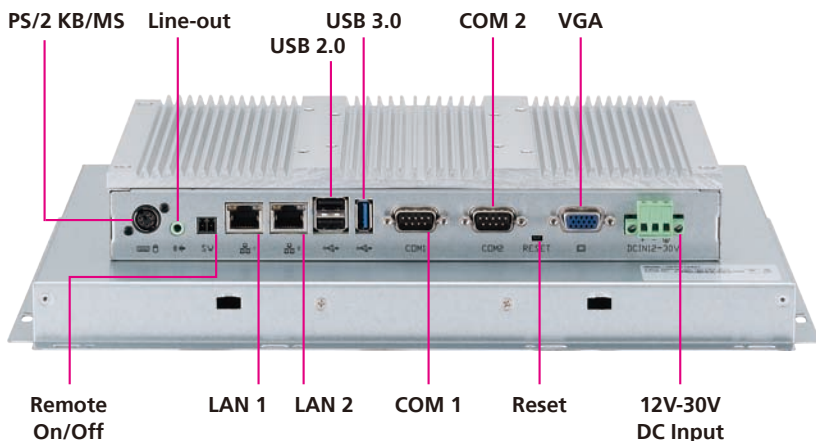

#### PS/2 KB/MS

Used to connect a PS/2 keyboard or a PS/2 mouse.

#### Line-out

Used to connect a headphone or a speaker.

#### Remote On/Off Switch

Used to connect a remote to power on/off the system.

#### LAN 1 and LAN 2

Used to connect the system to a local area network. LAN 1 supports Wake up on LAN.

#### USB 2.0

Dual USB 2.0 port for connecting USB 2.0/1.1 devices.

#### USB 3.0

Single USB 3.0 port for connecting the system with USB 3.0/2.0 devices.

#### COM 1 and COM 2

These COM ports support RS232/422/485 compatible series device through BIOS setting, and have 2.5kV isolated protection.

#### Reset Button

Press this button to restart the system.

#### VGA

Used to connect an analog VGA monitor.

#### 12V-30V DC Input

Used to plug a DC power cord.

## Rear

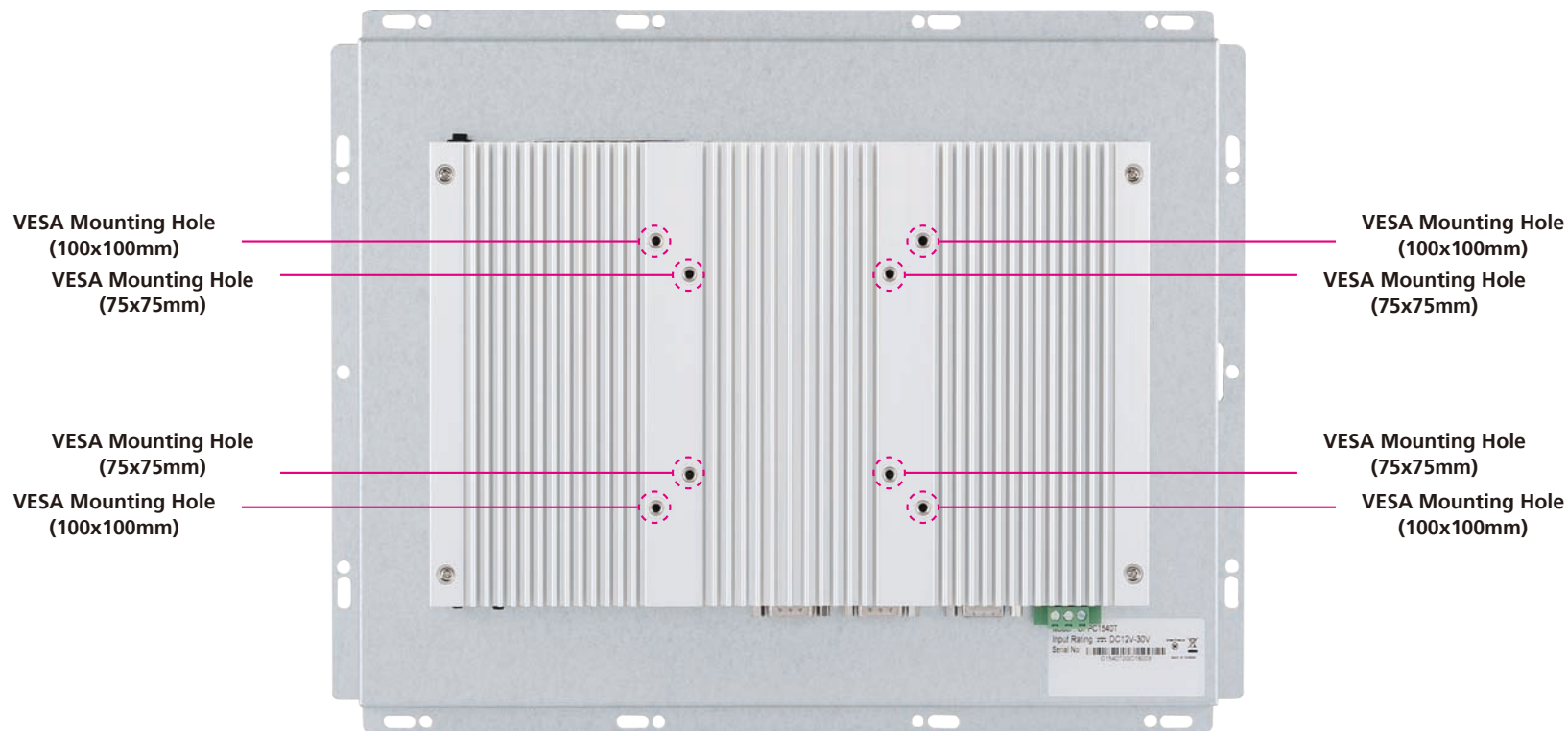

### VESA Mounting Holes

These are the mounting holes for VESA mounting (100x100mm and 75x75mm)

# Mechanical Dimensions

## OPPC 1540HT-J1900

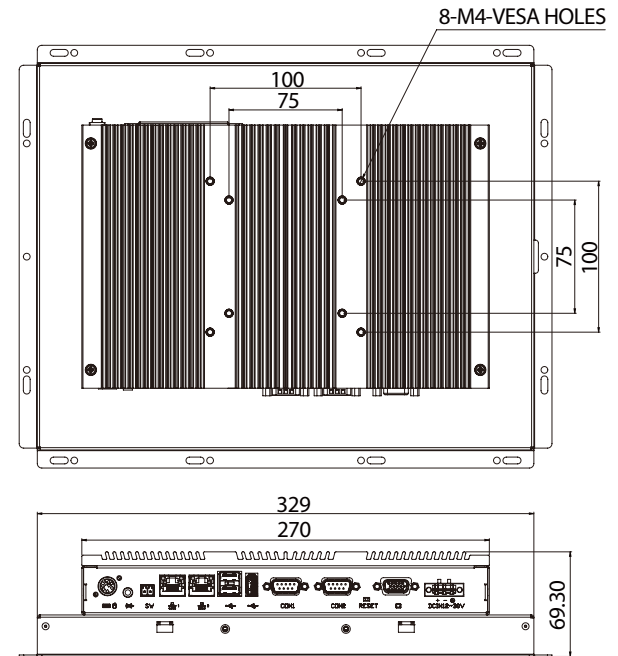
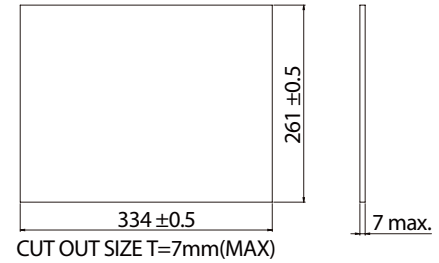
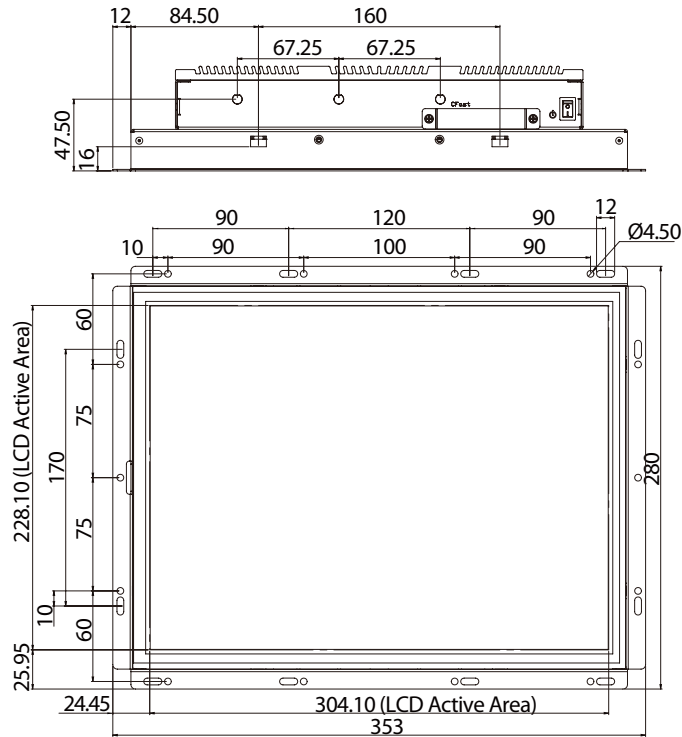



# OPPC 1940HT-J1900

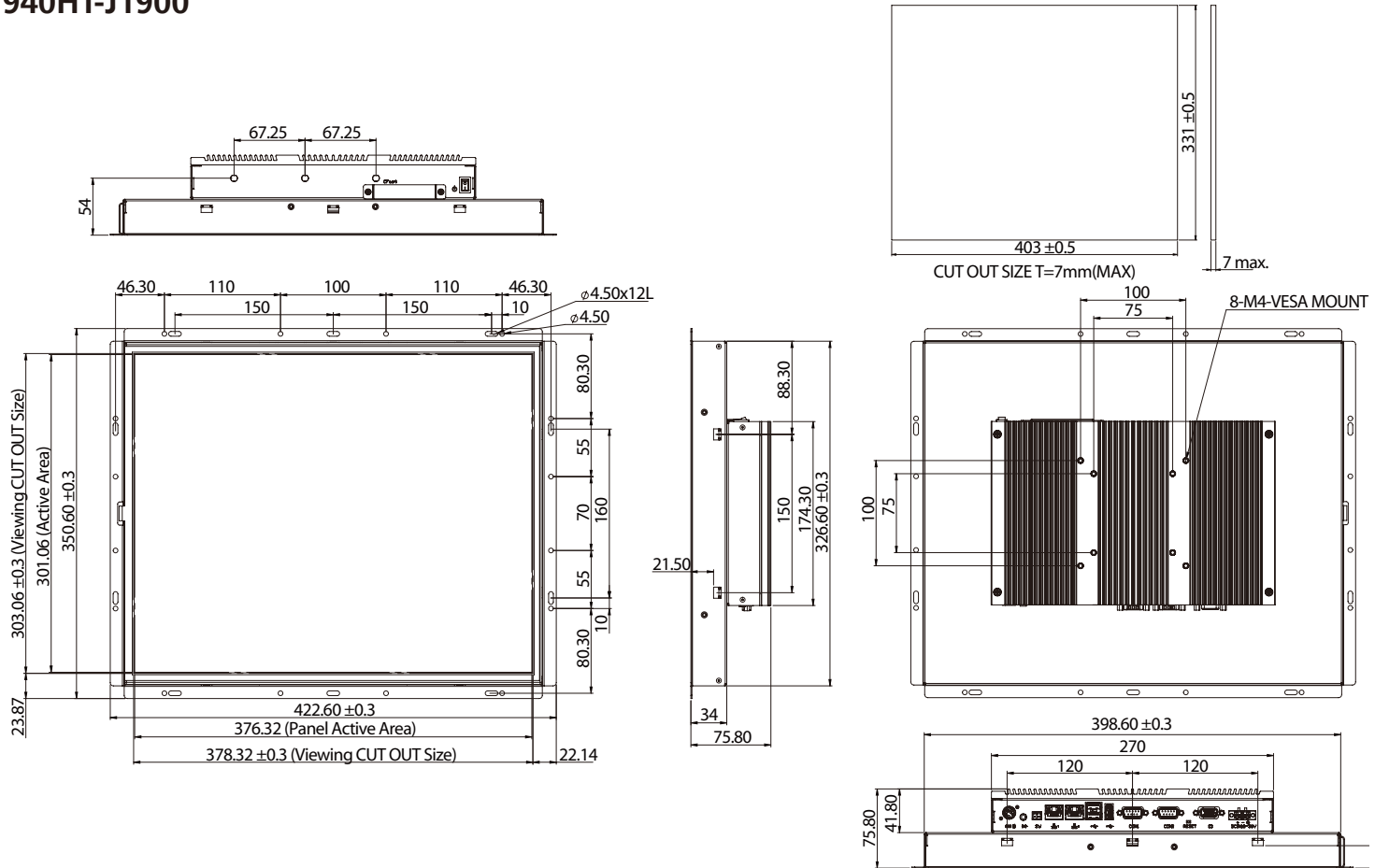

## CHAPTER 2: JUMPERS AND CONNECTORS

This chapter describes how to set the jumpers and connectors on the motherboard. Note that information in this chapter applies to OPPC 1540HT-J1900 and OPPC 1940HT-J1900.

### Before You Begin

- Ensure you have a stable, clean working environment. Dust and dirt can get into components and cause a malfunction. Use containers to keep small components separated.
- Adequate lighting and proper tools can prevent you from accidentally damaging the internal components. Most of the procedures that follow require only a few simple tools, including the following:
  - A Philips screwdriver
  - A flat-tipped screwdriver
  - A set of jewelers screwdrivers
  - A grounding strap
  - An anti-static pad
- Using your fingers can disconnect most of the connections. It is recommended that you do not use needle-nosed pliers to disconnect connections as these can damage the soft metal or plastic parts of the connectors.
- Before working on internal components, make sure that the power is off. Ground yourself before touching any internal components, by touching a metal object. Static electricity can damage many of the electronic

components. Humid environments tend to have less static electricity than dry environments. A grounding strap is warranted whenever danger of static electricity exists.

### Precautions

Computer components and electronic circuit boards can be damaged by discharges of static electricity. Working on computers that are still connected to a power supply can be extremely dangerous.

Follow the guidelines below to avoid damage to your computer or yourself:

- Always disconnect the unit from the power outlet whenever you are working inside the case.
- If possible, wear a grounded wrist strap when you are working inside the computer case. Alternatively, discharge any static electricity by touching the bare metal chassis of the unit case, or the bare metal body of any other grounded appliance.
- Hold electronic circuit boards by the edges only. Do not touch the components on the board unless it is necessary to do so. Don't flex or stress the circuit board.
- Leave all components inside the static-proof packaging that they shipped with until they are ready for installation. Use correct screws and do not over tighten screws.

## Jumper Settings

A jumper is the simplest kind of electric switch. It consists of two metal pins and a cap. When setting the jumpers, ensure that the jumper caps are placed on the correct pins. When the jumper cap is placed on both pins, the jumper is short. If you remove the jumper cap, or place the jumper cap on just one pin, the jumper is open.

Refer to the illustrations below for examples of what the 2-pin and 3-pin jumpers look like when they are short (on) and open (off).

Two-Pin Jumpers: Open (Left) and Short (Right)

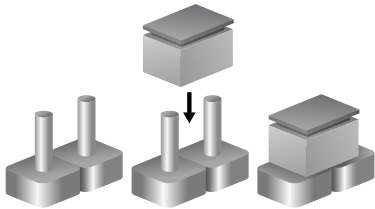

Three-Pin Jumpers: Pins 1 and 2 are Short

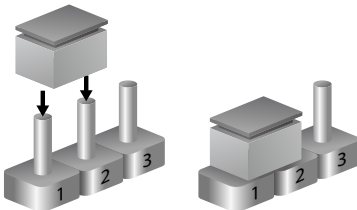

# Locations of the Jumpers and Connectors

## Top View

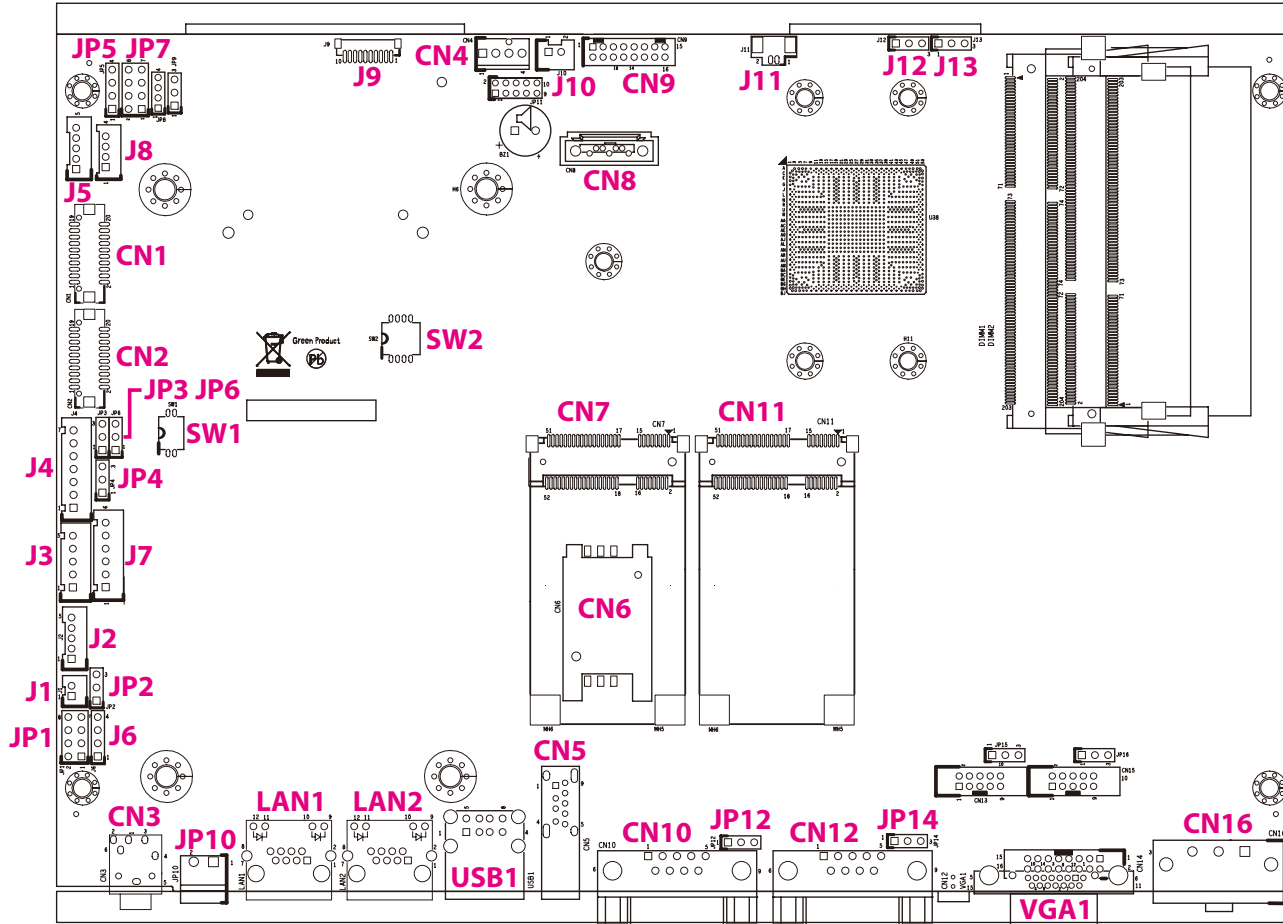

## Bottom View

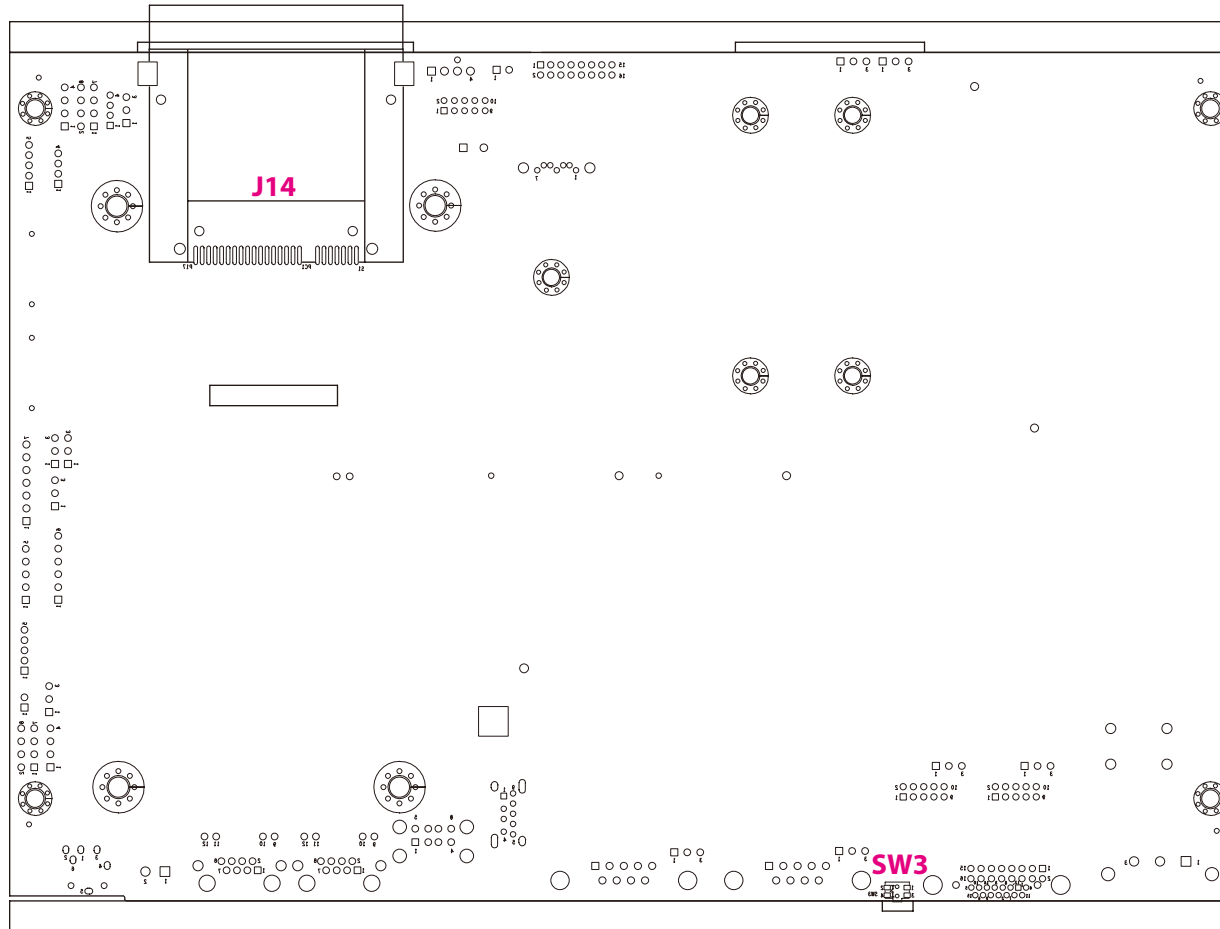

## Jumpers and DIP Switch Settings

### RTC and SRTC Clear Select

Connector type: 1x3 3-pin header, 2.54mm pitch  
Connector location: J12 (RTC) and J13 (SRTC)



Pin	Settings
1-2 On	Normal
2-3 On	Clear

1-2 On: default

Pin	Definition
1	NC
2	RTC Power
3	GND

### AT/ATX Power Select

Connector type: 1x3 3-pin header, 2.54mm pitch  
Connector location: JP2



Pin	Settings
1-2 On	AT Mode
2-3 On	ATX Mode

2-3 On: default

Pin	Definition
1	AUTO (AT MODE)
2	PWRBT In
3	Manual ( ATX MODE)

## Dimming Signal Level Select

Connector type: 1x3 3-pin header, 2.54mm pitch

Connector location: JP6



Pin	Settings	Model
1-2 On	3.3V	OPPC 1940HT-J1900
2-3 On	5V	OPPC 1540HT-J1900

1-2 On: default

Pin	Definition
1	VCC3
2	Power for Dimming
3	VCC5

## LCD Panel VDD Power Select

Connector type: 1x3 3-pin header, 2.54mm pitch

Connector location: JP3



Pin	Settings	Model
1-2 On	3.3V	OPPC 1540HT-J1900
2-3 On	5V	OPPC 1940HT-J1900

1-2 On: default

Pin	Definition
1	VCC3
2	Power for VDD
3	VCC5

## Touch 4/5 Wire Select

Connector type: 1x3 3-pin header, 2.54mm pitch

Connector location: JP4



Pin	Settings
1-2 On	5 wire
2-3 On	4 wire

1-2 On: default

## COM1 RI Pin Power Select

Connector type: 1x3 3-pin header, 2.54mm pitch

Connector location: JP12



Pin	Settings
1-2 On	RING
2-3 On	+5V

1-2 On: default

Pin	Definition
1	SP1_RI
2	SP1_PSRI
3	VCC5



## COM2 RI Pin Power Select

Connector type: 1x3 3-pin header, 2.54mm pitch

Connector location: JP14



Pin	Settings
1-2 On	RING
2-3 On	+12V

1-2 On: default

Pin	Definition
1	SP2_RI
2	SP2_PSRI
3	12V

## Panel Resolution Select

Connector type: 4-pin DIP switch

Connector location: SW2

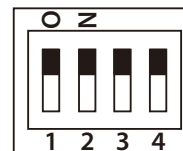

Resolution	SW2-1	SW2-2	SW2-3	SW2-4	Model
1024 x 768	ON	OFF	ON	ON	OPPC 1540HT-J1900
1280 x 1024	OFF	ON	ON	OFF	OPPC 1940HT-J1900

## Dimming Type Select

Connector type: 2-pin DIP switch

Connector location: SW1

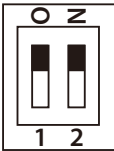

TYPE	SW1-1	SW1-2
PWM Mode	ON	OFF
Analog Mode	OFF	ON

## Connector Pin Definitions

### External I/O Interfaces

#### Line-out Connector

Connector type: 1x 3.5mm TRS

Connector location: CN3



Pin	Definition	Pin	Definition
1	LOUT_R	2	JD
3	NC	4	LOUT_L
5	GND	6	GND

#### Remote Power On/Off Switch

Connector type: 2-pin switch

Connector location: JP10



Pin	Definition
1	PWRBT
2	GND

## LAN1 Port

### Support Wake on LAN (WOL)

Connector type: RJ45 port with LEDs

Connector location: LAN1

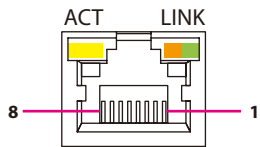

Act	Status
Flashing Yellow	Data activity
Off	No activity

Link	Status
Steady Green	1G network link
Steady Orange	100Mbps network link
Off	10Mbps or no link

Pin	Definition	Pin	Definition
1	LAN1M0P	2	LAN1M0N
3	LAN1M1P	4	LAN1M2P
5	LAN1M2N	6	LAN1M1N
7	LAN1M3P	8	LAN1M3N

## LAN2 Port

Connector type: RJ45 port with LEDs

Connector location: LAN2

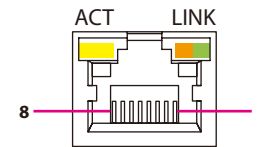

Act	Status
Flashing Yellow	Data activity
Off	No activity

Link	Status
Steady Green	1G network link
Steady Orange	100Mbps network link
Off	10Mbps or no link

Pin	Definition	Pin	Definition
1	LAN2M0P	2	LAN2M0N
3	LAN2M1P	4	LAN2M2P
5	LAN2M2N	6	LAN2M1N
7	LAN2M3P	8	LAN2M3N

## Dual USB 2.0 Port

Connector type: USB 2.0 ports, Type A

Connector location: USB1

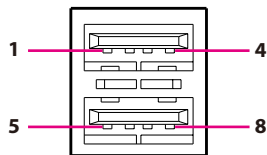

Pin	Definition	Pin	Definition
1	VCC5	2	USB 2N
3	USB 2P	4	GND
5	VCC5	6	USB 1N
7	USB 1P	8	GND

## Single USB 3.0 Port

Connector type: USB 3.0 port, Type A

Connector location: CN5

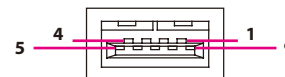

Pin	Definition	Pin	Definition
1	VCC5	2	USB 0N
3	USB 0P	4	GND
5	USB3_RX0_N	6	USB3_RX0_P
7	GND	8	USB3_TX0_N
9	USB3_TX0_P		

## COM1 Port

Connector type: DB-9 port, 9-pin D-Sub

Connector location: CN10

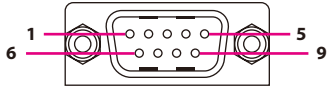

Pin	RS232	RS422	RS485
1	COM1_DCD	COM1_TXD-	COM1_TXD- COM1_RXD-
2	COM1_RXD	COM1_TXD+	COM1_TXD+ COM1_RXD+
3	COM1_TXD	COM1_RXD+	Reserve
4	COM1_DTR	COM1_RXD-	Reserve
5	COM1_GND	COM1_GND	Reserve
6	COM1_DSR	COM1_RTS-	Reserve
7	COM1_RTS	COM1_RTS+:	Reserve
8	COM1_CTS	COM1_CTS+	Reserve
9	COM1_RI (Could be a +5V Power Pin)	COM1_CTS- (Could be a +5V Power Pin)	Reserve (Could be a +5V Power Pin)

## COM2 Port

Connector type: DB-9 port, 9-pin D-Sub

Connector location: CN12

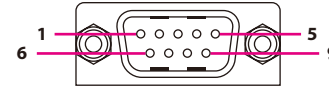

Pin	RS232	RS422	RS485
1	COM2_DCD	COM2_TXD-	COM2_TXD- COM2_RXD-
2	COM2_RXD	COM2_TXD+	COM2_TXD+ COM2_RXD+
3	COM2_TXD	COM2_RXD+	Reserve
4	COM2_DTR	COM2_RXD-	Reserve
5	COM2_GND	COM2_GND	Reserve
6	COM2_DSR	COM2_RTS-	Reserve
7	COM2_RTS	COM2_RTS+	Reserve
8	COM2_CTS	COM2_CTS+	Reserve
9	COM2_RI (Could be a +12V Power Pin)	COM2_CTS- (Could be a +12V Power Pin)	Reserve (Could be a +12V Power Pin)

## VGA Port

Connector type: DB-15 port, 15-pin D-Sub

Connector location: VGA1

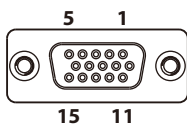

Pin	Definition	Pin	Definition
1	Red	2	Green
3	Blue	4	N/C
5	GND	6	GND
7	GND	8	GND
9	+5V	10	GND
11	N/C	12	DDC Data
13	HSYNC	14	VSYNC
15	DDC Clock		

## 12V - 30V DC Power Input

Connector type: Phoenix Contact 1x3 3-pin terminal block

Connector location: CN16

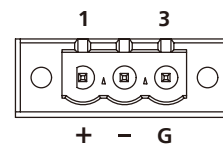

Pin	Definition
1	DC+
2	DC-
3	GND

## CFast Card Slot

Connector type: Standard CFast connector

Connector location: J14

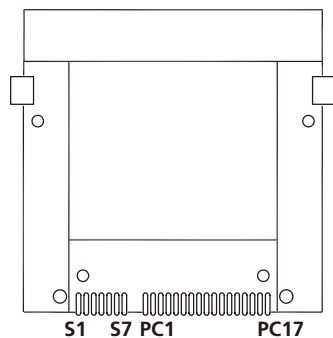

Pin	Definition	Pin	Definition
S1	GND	S2	SATA_TXP2
S3	SATA_TXN2	S4	GND
S5	SATA_RXN2	S6	SATA_RXP2
S7	GND	PC1	CFAST_CDI
PC2	GND	PC3	NC
PC4	NC	PC5	NC
PC6	NC	PC7	GND
PC8	CFAST_LED1_C	PC9	CFAST_LED2_C
PC10	NC	PC11	NC
PC12	NC	PC13	VCC3
PC14	VCC3	PC15	GND
PC16	GND	PC17	CFAST_CDO

## Reset Button

Connector location: SW3



Pin	Definition
1	Reset
2	Reset
3	GND
4	GND



## Internal Connectors

### CCFL Panel Backlight Connector

Connector type: 1x7 7-pin header JST, 2.5mm pitch

Connector location: J4

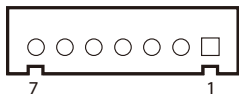

Pin	Definition	Pin	Definition
1	VCC5	2	12V
3	12V	4	BKCTRL
5	GND	6	GND
7	BKLEN		

### LVDS Channel A

Connector type: 2x10 20-pin header, 1.25mm pitch

Connector location: CN2

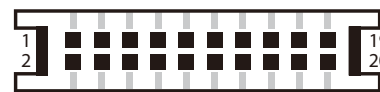

Pin	Definition	Pin	Definition
1	NC	2	NC
3	VDD	4	LVDS_DAT0P
5	LVDS_DAT3P	6	LVDS_DAT0N
7	LVDS_DAT3N	8	VDD
9	GND	10	LVDS_DAT1P
11	LVDS_CLK1P	12	LVDS_DAT1N
13	LVDS_CLK1N	14	GND
15	GND	16	+12V
17	LVDS_DAT2P	18	+12V
19	LVDS_DAT2N		

## LVDS Channel B

Connector type: 2x10 20-pin header, 1.25mm pitch

Connector location: CN1

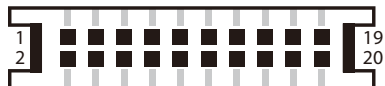

Pin	Definition	Pin	Definition
1	NC	2	NC
3	VDD	4	LVDS_DAT4P
5	LVDS_DAT7P	6	LVDS_DAT4N
7	LVDS_DAT7N	8	VDD
9	GND	10	LVDS_DAT5P
11	LVDS_CLK2P	12	LVDS_DAT5N
13	LVDS_CLK2N	14	GND
15	GND	16	+12V
17	LVDS_DAT6P	18	+12V
19	LVDS_DAT6N		

## Line-in/Mic-in Connector

Connector type: 2x4 8-pin header, 2.54mm pitch

Connector location: JP1

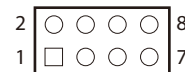

Pin	Definition	Pin	Definition
1	LINE IN-LP	2	MIC1_L3
3	LINE IN-JD	4	MIC_JD
5	GND	6	GND
7	LINE IN-RP	8	MIC1_R3

## Speaker-out Connector

Connector type: 1x4 4-pin header, 2.54mm pitch  
Connector location: J6



Pin	Definition
1	OUT-L+
2	OUT-L-
3	OUT-R+
4	OUT-R-

## USB Connector

Connector type: 1x6 6-pin header JST, 2.5mm pitch  
Connector location: J7

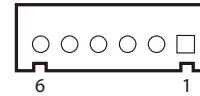

Pin	Definition	Pin	Definition
1	+5V	2	HUBUSB DM1
3	HUBUSB DP1	4	HUBUSB DM2
5	HUBUSB DP2	6	GND

## Touch Sensor Connector

Connector type: 1x5 5-pin header JST, 2.5mm pitch

Connector location: J3



Pin	4-wire	5-wire
1	Bottom	UR (H)
2	Right	LR (X)
3	N/A	Sense (S)
4	Top	UL (Y)
5	Left	LL (L)

## SATA Connector

Connector type: Standard Serial ATA 7P (1.27mm, SATA-M-180)

Connector location: CN8

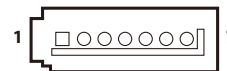

Pin	Definition	Pin	Definition
1	GND	2	TXP0
3	TXN0	4	GND
5	RXN0	6	RXP0
7	GND	8	

## SATA DOM Power Connector

Connector type: 1x2 2-pin header, JST 2.5mm pitch  
Connector location: J10



Pin	Definition
1	+5V
2	GND

## DIO Connector (Optional)

Connector type: 2x8 16-pin header, 2.54mm pitch  
Connector location: CN9

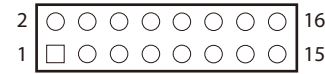

Pin	Definition	Pin	Definition
1	DI1	2	DO1
3	DI2	4	DO2
5	DI3	6	DO3
7	DI4	8	DO4
9	NC	10	NC
11	COM1	12	NC
13	GND	14	GND
15	GND	16	GND

## Keyboard/Mouse Connector

Connector type: 2x4 8-pin header, 2.54mm pitch

Connector location: JP7

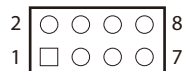

Pin	Definition	Pin	Definition
1	VCC5	2	VCC5
3	KB_DATA	4	MS_DATA
5	KB_CLK	6	MS_CLK
7	GND	8	GND

## Active LED Connector

Connector type: 1x6 6-pin header JST, 2.5mm pitch

Connector location: J2



Pin	Definition	Pin	Definition
1	HDD_GND	2	HDD_PWR
3	PWR_GND	4	5VSB
5	VCC5		

## Power Button

Connector type: 1x2 2-pin header JST, 2.0mm pitch

Connector location: J1

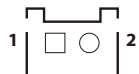

Pin	Definition
1	PWRBT
2	GND

## Backlight Control Input Connector

Connector type: 1x4 4-pin header JST, 2.0mm pitch

Connector location: J8

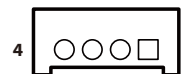

Pin	Definition
1	GND
2	Tact Switch input
3	PIR IN
4	VCC3

## Dimming Control Input Connector

Connector type: 1x5 5-pin header JST, 2.0mm pitch

Connector location: J5



Pin	Definition	Pin	Definition
1	GND	2	Decreased input
3	Increased input	4	Light sensor input
5	VCC3		

## LVDS MCU FW Debug Connector

Connector type: 1x4 4-pin header, 2.54mm pitch

Connector location: JP5



Pin	Definition
1	VCC3
2	MCU_TCK
3	MCU_TDIO
4	GND



## Smart Fan Connector

Connector type: 1x4 4-pin Wafer, 2.54mm pitch

Connector location: CN4



Pin	Definition
1	GND
2	+12V
3	CPUFANIN
4	CPUFANOUT

## Battery Connector

Connector type: 1x2 2-pin header JST, 1.25mm pitch

Connector location: J11



Pin	Definition
1	VBAT
2	GND

## Post Code Debug Connector

Connector type: 1x10 10-pin header, 1.0mm pitch

Connector location: J9



Pin	Definition	Pin	Definition
1	GND	2	PLTRST#
3	LPC_CLK	4	LPC_FRAME#
5	LPC_AD3	6	LPC_AD2
7	LPC_AD1	8	LPC_ADO
9	VCC3	10	VCC3

## SIM Card Slot

Connector location: CN6

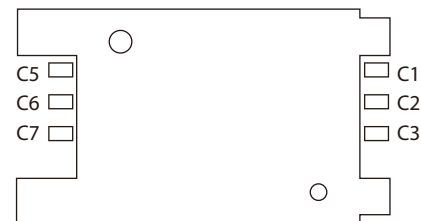

Pin	Definition	Pin	Definition
C1	UIM_PWR	C2	UIM_RST
C3	UIM_CLK	C5	GND
C6	UIM_VCCP	C7	UIM_DAT

## Mini-PCIe Slot

Connector location: CN11

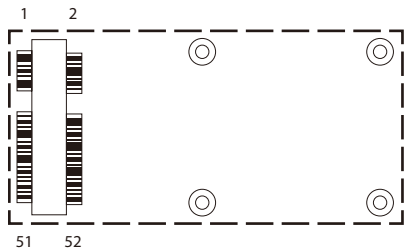

Pin	Definition	Pin	Definition
1	WAKE0#	2	+V3.3_MINI
3	NC	4	GND
5	NC	6	+V1.5S_MINI
7	NC	8	NC
9	GND	10	NC
11	GPP_CLK1_N	12	NC
13	GPP_CLK1_P	14	NC
15	GND	16	NC
17	NC	18	GND
19	NC	20	MINICARD1_DIS#
21	GND	22	PCIE_RST#
23	PCIE_RX2N	24	+V3.3A_MINI
25	PCIE_RX2P	26	GND

Pin	Definition	Pin	Definition
27	GND	28	+V1.5S_MINI
29	GND	30	SMB_CLK
31	PCIE_TX3N	32	SMB_DAT
33	PCIE_TX3P	34	GND
35	GND	36	USB_1N
37	GND	38	USB_1P
39	+V3.3A_MINI	40	GND
41	+V3.3A_MINI	42	NC
43	GND	44	NC
45	NC	46	NC
47	NC	48	+V1.5S_MINI
49	NC	50	GND
51	NC	52	+V3.3A_MINI

## Mini-PCIe Slot (Wi-Fi/3G)

Connector location: CN7

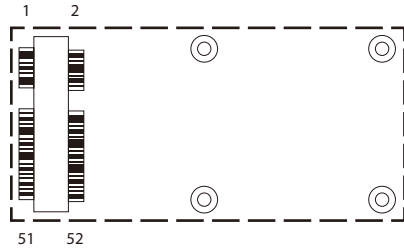

Pin	Definition	Pin	Definition
1	PCIEWAKE	2	3.3V
3	NC	4	GND
5	NC	6	1.5V
7	CLKREQ	8	UIM_PWR
9	GND	10	UIM_DAT
11	PCIECLKN	12	UIM_CLK
13	PCIECLKP	14	UIM_RST
15	GND	16	UIM_VCCP
17	NC	18	GND
19	NC	20	DISABLE
21	GND	22	PLTRSTBF
23	PCIERX4N	24	3.3V
25	PCIERX24P	26	GND

Pin	Definition	Pin	Definition
27	GND	28	1.5V
29	GND	30	SMBCLK
31	PCIETX4N	32	SMBDATA
33	PCIETX4P	34	GND
35	GND	36	USB2N
37	GND	38	USB2P
39	3.3V	40	GND
41	3.3V	42	NC
43	GND	44	NC
45	NC	46	NC
47	NC	48	1.5V
49	NC	50	GND
51	NC	52	3.3V

# Block Diagram

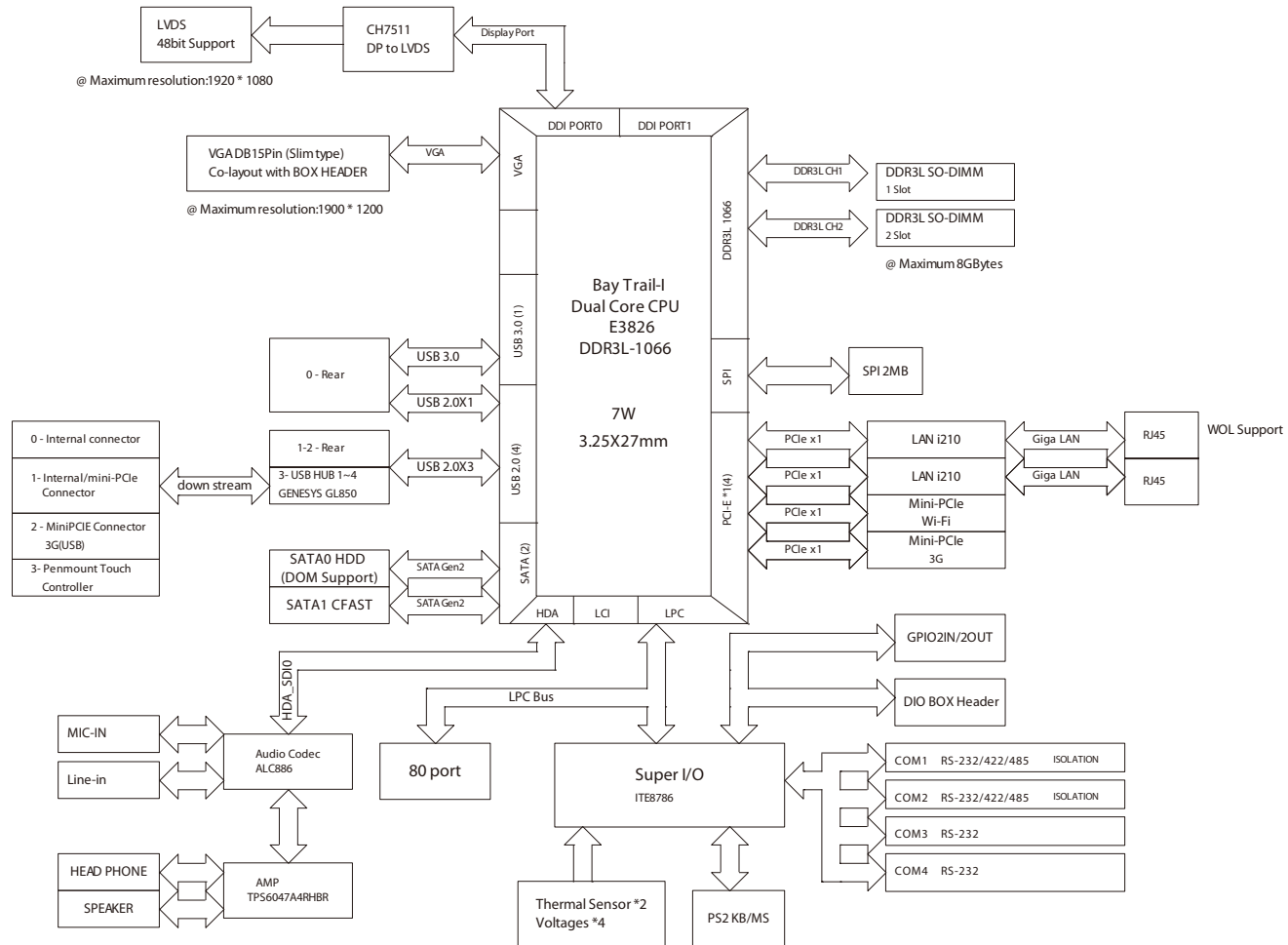

## CHAPTER 3: SYSTEM SETUP

### Installing a SATA Hard Drive



Prior to removing the chassis cover, make sure the unit's power is off and disconnected from the power sources to prevent electric shock or system damage.

1. Remove the mounting screws around the chassis cover and then remove the cover.

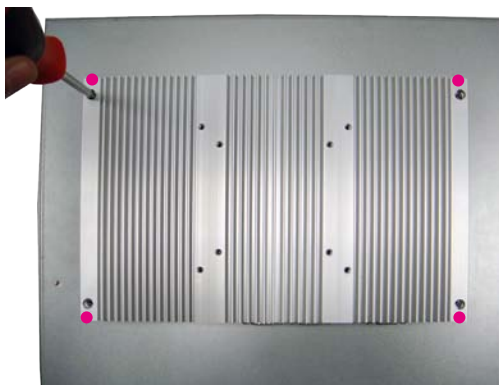

The dots denote the locations of the screws.

2. Remove the mounting screws of the drive bay.

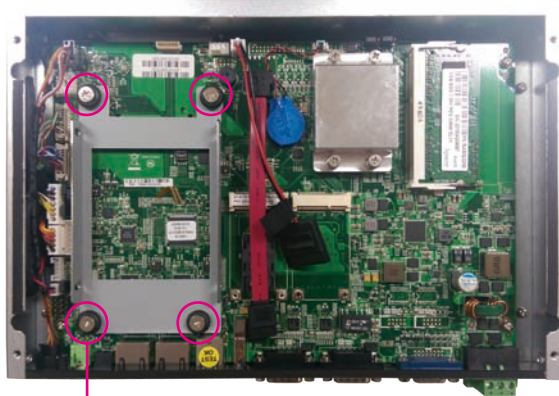

Mounting screw

3. Remove the drive bay. The drive bay is used to hold a SATA hard drive.



4. Place the SATA hard drive on the drive bay.

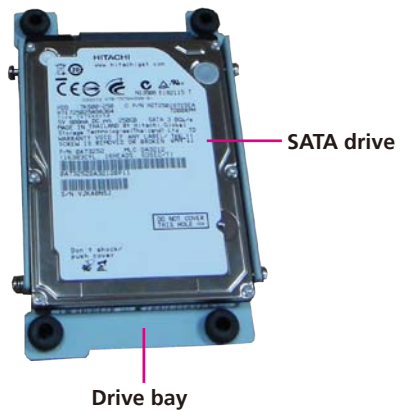

5. Align the mounting holes that are on the sides of the SATA drive with the mounting holes on the drive bay and then use the provided mounting screws to secure the drive in place.

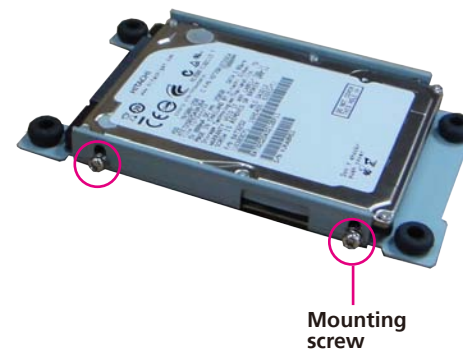



6. Place the SATA drive in the chassis and then use the provided mounting screws to secure the drive in the chassis.

Connect the SATA data cable and SATA power cable to the connectors on the SATA drive.

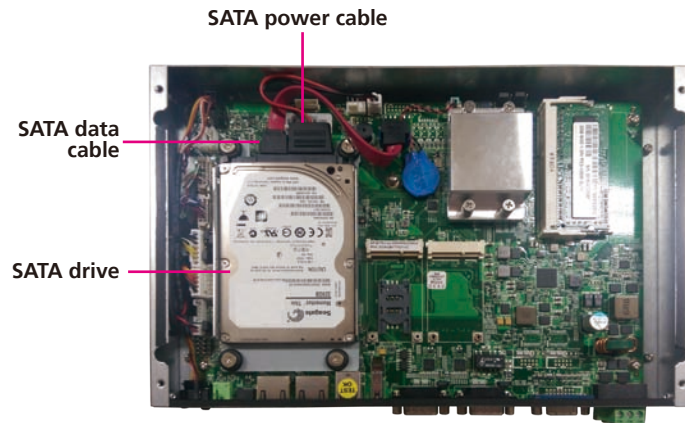

## Installing a CFAST Card

1. The CFAST card socket is located on the rear top side of the chassis.



2. Remove the mounting screws of the CompactFlash socket's cover.

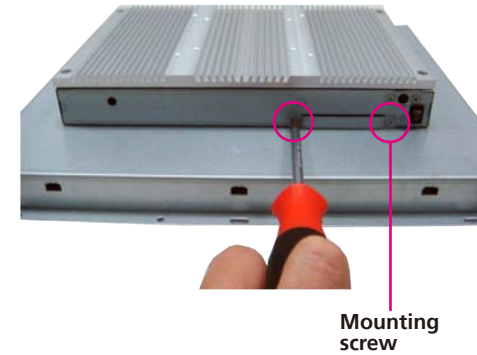

3. With the CFast card's label facing up, insert the card until it is completely seated in the socket.



CFast card

4. Push the CFast card to remove it.

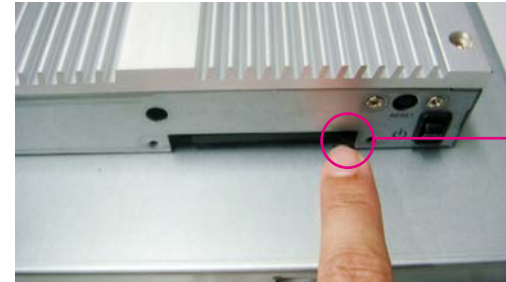

Push CFast card

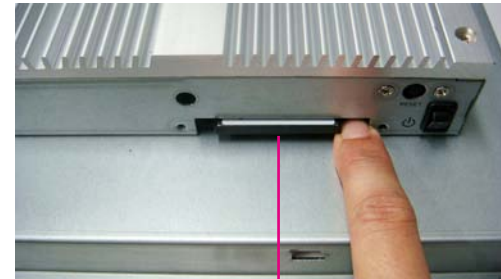

Ejected CFast card

## Installing a SO-DIMM Memory Module

1. With the chassis cover removed, insert the module into the SO-DIMM socket at an approximately 30 degrees angle. Apply firm even pressure to each end of the module until it slips into the socket. The gold-plated connector on the edge of the module will almost completely disappear inside the socket.
2. Push the module down until the clips on both sides of the socket lock into position. You will hear a distinctive “click” sound, indicating the module is correctly locked into position.



## Installing a SATA DOM

1. Remove the drive bay bracket and cable. The SATA connector is readily accessible upon removing the bracket.
2. Remove the screw.

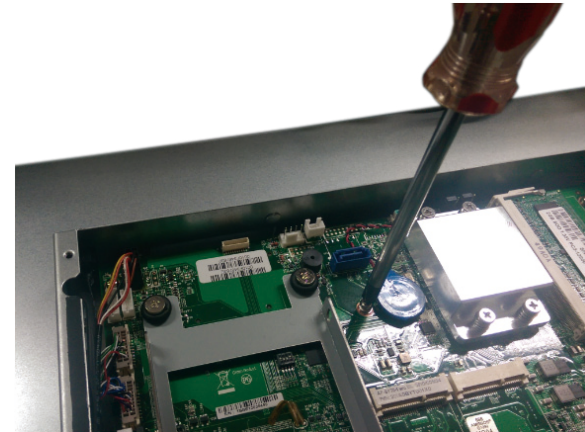

3. The SATA DOM package includes a SATA DOM, supporting stud and cable.

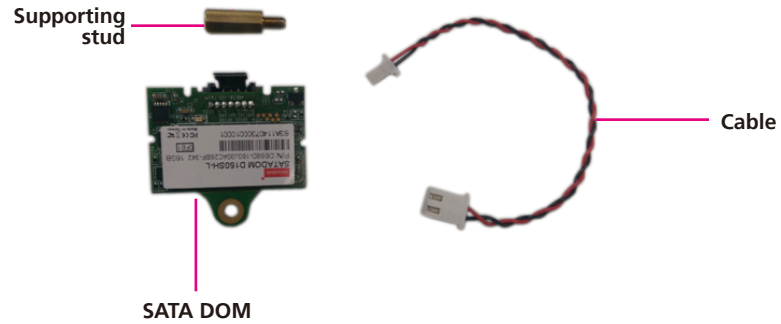

4. Install the supporting stud. Make sure the stud is fastened in place.

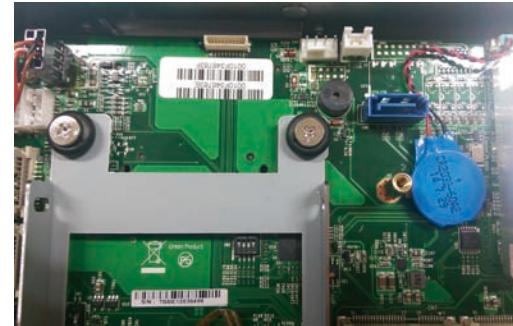

5. Connect one end of the provided cable to the connector on the module.

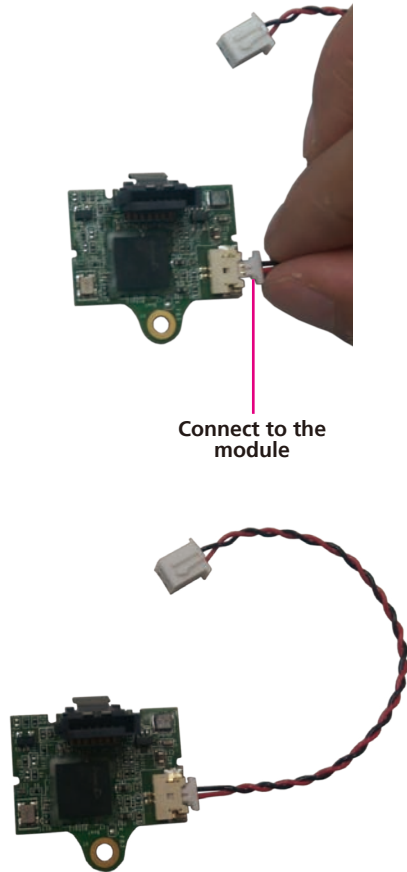

6. Install the module to the SATA port via the connector at the solder side of the module and then secure the module using the mounting screw you removed in step 2. Connect one end of the provided cable to the connector on the board.

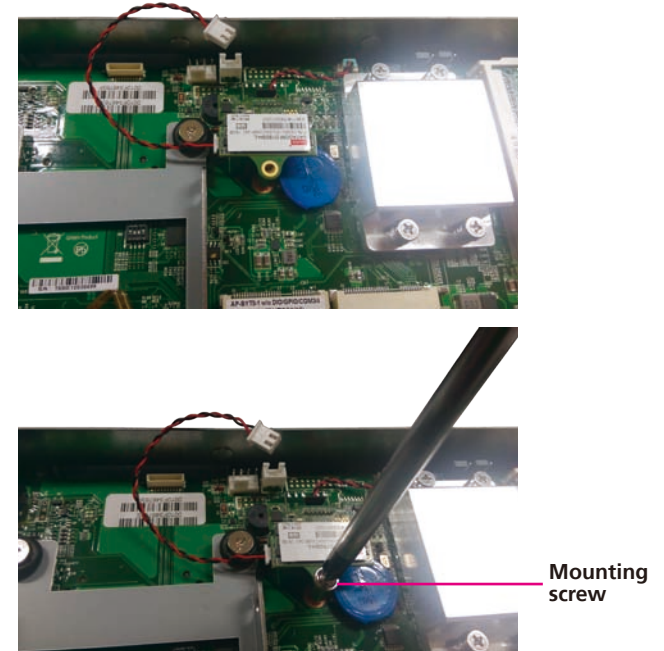

7. Connect the other end of the cable to the connector on the board.

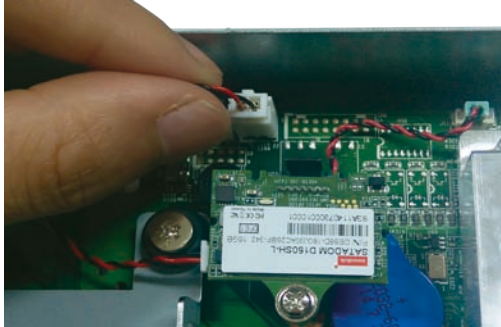



## Installing a Mini PCIe Module

1. The Mini PCIe module package includes the following items.



Mini PCIe Module



Antennas



RF Cables

2. Insert the Mini PCIe module into the Mini PCIe slot at a 45 degrees angle until the gold-plated connector on the edge of the module completely disappears inside the slot.

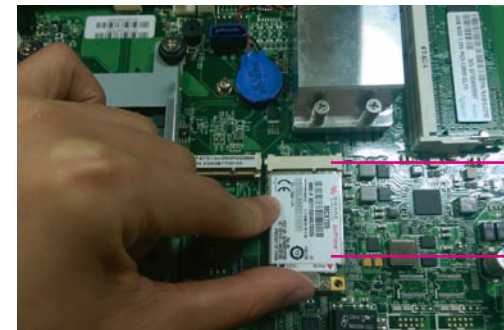

Mini PCIe slot

Mini PCIe module

3. Secure the module with mounting screws.

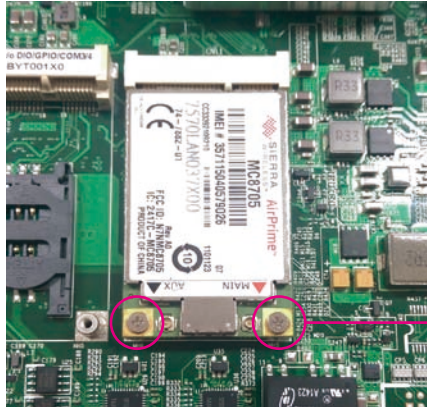

Mounting screw

4. Attach one end of the RF cables onto the module.



RF cable

5. Push the antenna hole cover.



7. Insert the antenna jack end of the cable through the antenna hole.



6. Remove the antenna hole covers.



8. Insert the ring onto the antenna jack end of the cable.

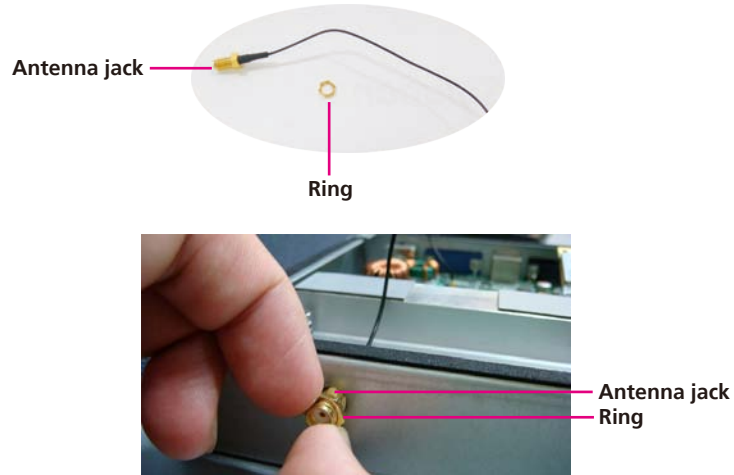

9. Connect external antennas to the antenna jacks.

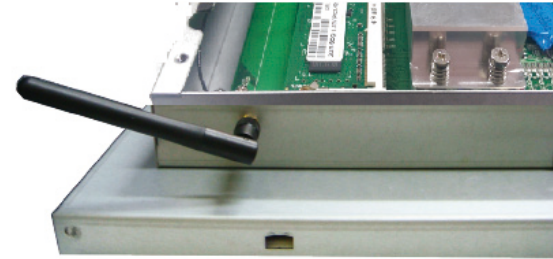

## Installing the Front Bezel on OPPC 1540HT-J1900 (Optional)



Note: The installation instructions are the same as those for OPPC 1520T. Images are based on OPPC 1520T.

1. The optional front bezel kit includes a front bezel, brackets, and mounting screws.



Front view of the bezel

2. The photo below shows the rear view of the bezel and the corresponding brackets and mounting screws needed to mount the bezel.

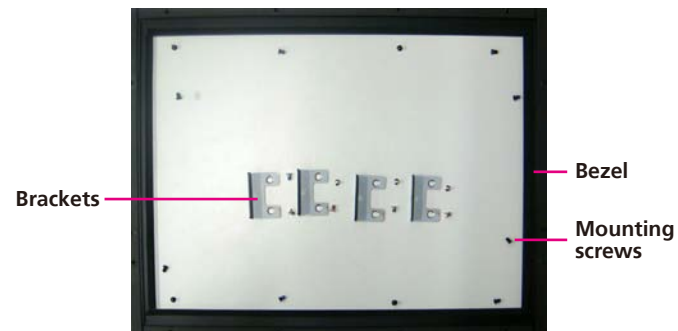

Rear view of the bezel

3. Mount the brackets to their corresponding mounting holes located on the sides of the Panel PC.

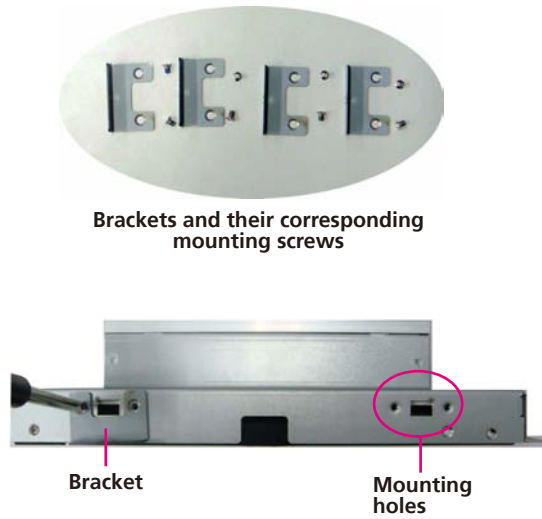

4. The photo below shows the 4 brackets mounted in place.



5. Attach the front bezel onto the Panel PC.

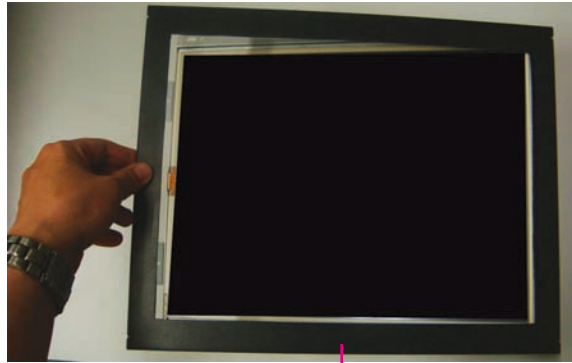

Front bezel

6. Viewing from the rear side of the bezel, the red dots denote the locations of the mounting screws.



Rear view

7. With the rear side of the Panel PC facing up, secure the front bezel with the provided mounting screws.

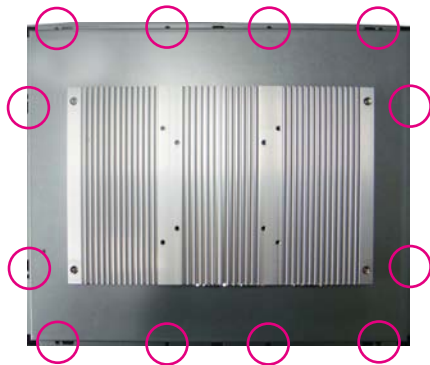
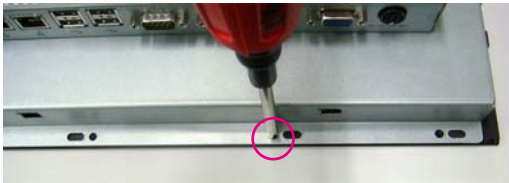

8. The photo below shows the front bezel already secured in place.

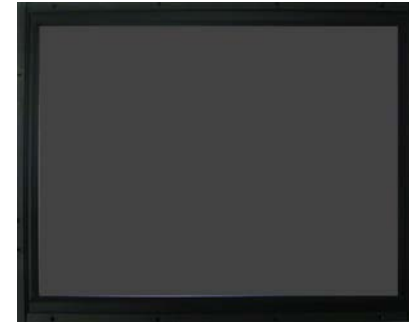



## Installing the Front Bezel on OPPC 1940HT-J1900 (Optional)



Note: The installation instructions are the same as those for OPPC 1720T. Images are based on OPPC 1720T.

1. The optional front bezel kit includes a front bezel and mounting screws.



Front view of the bezel

2. The photo below shows the rear view of the bezel and the corresponding brackets and mounting screws needed to mount the bezel.

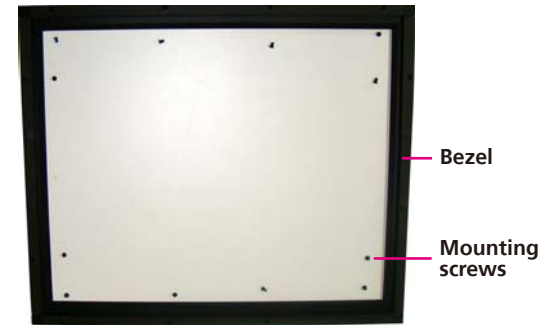

Rear view of the bezel

3. Attach the front bezel onto the Panel PC.



4. Viewing from the rear side of the bezel, the red dots denote the locations of the mounting screws.



5. With the rear side of the Panel PC facing up, secure the front bezel with the provided mounting screws.

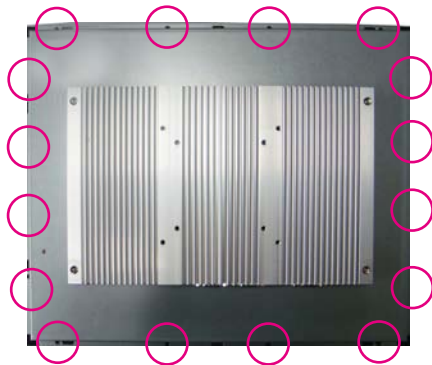

6. The photo below shows the front bezel already secured in place.

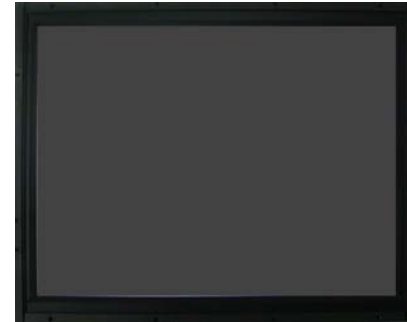

## Plugging the DC Power Cable

1. Plug the DC 4-pin DIN power jack (male) into the DC 4-pin DIN power jack (female) that is on the system.

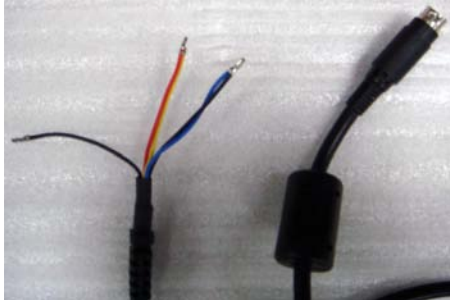

2. The table below shows the pin definition of the cable.

Color	Pin Definition
Black	GND
Red&Yellow	DC+
Blue&Black	DC-

## Panel Mounting

1. Select a place on the panel where you will mount the Panel PC.
2. Cut out a shape on the panel that corresponds to the Panel PC's rear dimensions.

The thickness of the panel (e.g. steel board, plank, acrylic board, wall, etc.) where you will mount the Panel PC must not exceed 7mm. If the distance between the front bezel and panel mount hole is too wide, it will not fit the panel mount kit.

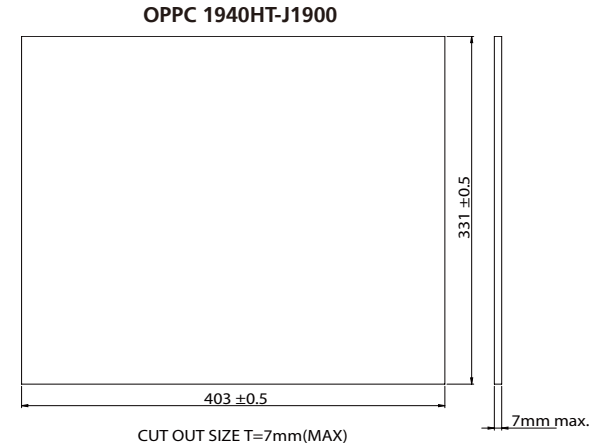
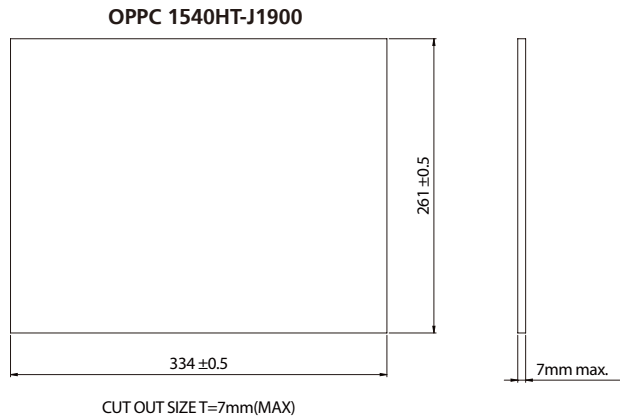

3. Slide the Panel PC through the hole until it is properly fitted against the panel.

## Panel Mount Kit (Optional)

1. The optional mounting clamps must be attached along the rear edges of the Panel PC.

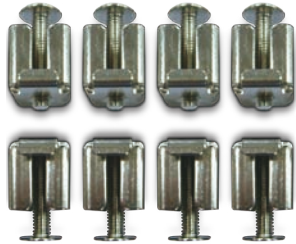

OPPC 1540HT-J1900

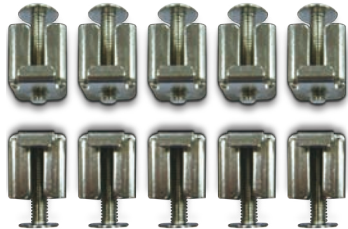

OPPC 1940HT-J1900

2. Position the mounting clamps along the rear edges of the Panel PC. The first and second clamps must be positioned and secured diagonally prior to mounting the rest of the clamps. Tighten the clamp's screw until it touches the panel. Do not overtighten the screws to prevent damaging the Panel PC.



3. The photo below shows the mounting clamps mounted in place.



OPPC 1540HT-J1900

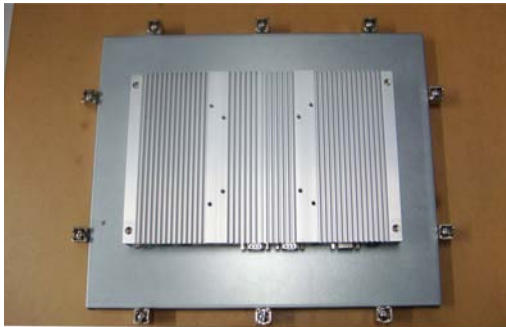

OPPC 1940HT-J1900

4. The photo below shows the front view of the Panel PC mounted on the panel.



OPPC 1540HT-J1900



OPPC 1940HT-J1900

## Front Bezel Design Guide

The illustration below shows the dimensions of the panel. It serves as a guide for you to design the front bezel.

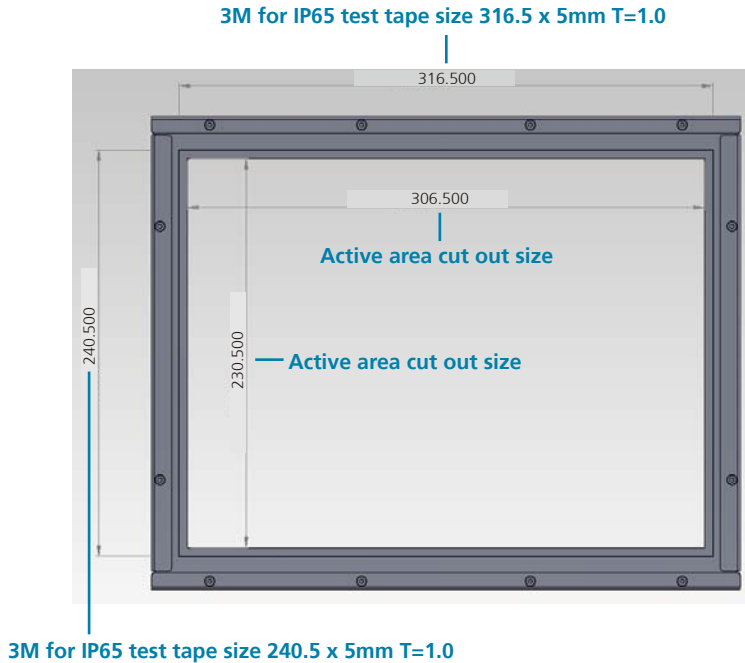

OPPC 1540HT-J1900

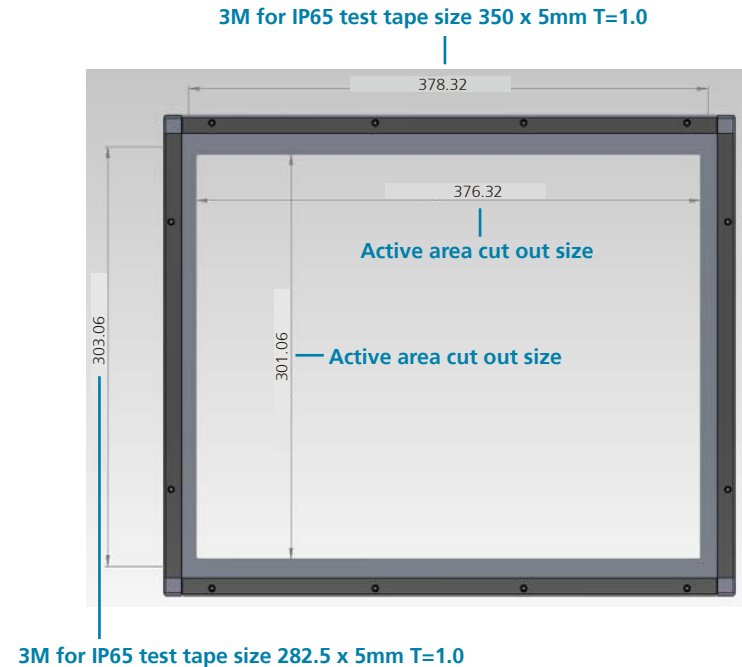

OPPC 1940HT-J1900



## Open Frame Mount

### Front Mount (Outer Side Mount)

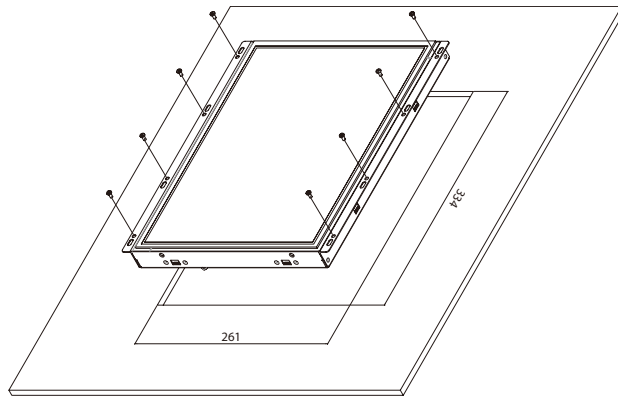

**OPPC 1540HT-J1900**

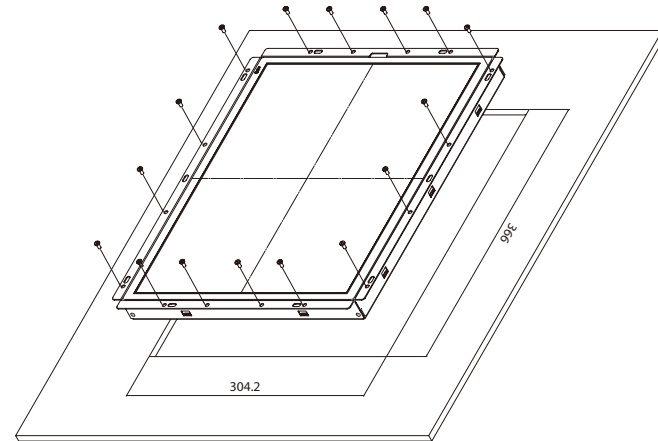

**OPPC 1940HT-J1900**



The cut out size of the Outer Side Mount is the same as the cut out size of the Panel Mount.

## CHAPTER 4: BIOS SETUP

This chapter describes how to use the BIOS setup program for the OPPC 1540HT-J1900/1940HT-J1900 series. The BIOS screens provided in this chapter are for reference only and may change if the BIOS is updated in the future.

To check for the latest updates and revisions, visit the NEXCOM website at [www.nexcom.com.tw](http://www.nexcom.com.tw).

### About BIOS Setup

The BIOS (Basic Input and Output System) Setup program is a menu driven utility that enables you to make changes to the system configuration and tailor your system to suit your individual work needs. It is a ROM-based configuration utility that displays the system's configuration status and provides you with a tool to set system parameters.

These parameters are stored in non-volatile battery-backed-up CMOS RAM that saves this information even when the power is turned off. When the system is turned back on, the system is configured with the values found in CMOS.

With easy-to-use pull down menus, you can configure such items as:

- Hard drives, diskette drives, and peripherals
- Video display type and display options
- Password protection from unauthorized use
- Power management features

The settings made in the setup program affect how the computer performs. It is important, therefore, first to try to understand all the setup options, and second, to make settings appropriate for the way you use the computer.

### When to Configure the BIOS

- This program should be executed under the following conditions:
- When changing the system configuration
- When a configuration error is detected by the system and you are prompted to make changes to the setup program
- When resetting the system clock
- When redefining the communication ports to prevent any conflicts
- When making changes to the Power Management configuration
- When changing the password or making other changes to the security setup

Normally, CMOS setup is needed when the system hardware is not consistent with the information contained in the CMOS RAM, whenever the CMOS RAM has lost power, or the system features need to be changed.

## Default Configuration

Most of the configuration settings are either predefined according to the Load Optimal Defaults settings which are stored in the BIOS or are automatically detected and configured without requiring any actions. There are a few settings that you may need to change depending on your system configuration.

## Entering Setup











When the system is powered on, the BIOS will enter the Power-On Self Test (POST) routines. These routines perform various diagnostic checks; if an error is encountered, the error will be reported in one of two different ways:

- If the error occurs before the display device is initialized, a series of beeps will be transmitted.
- If the error occurs after the display device is initialized, the screen will display the error message.

Powering on the computer and immediately pressing <Del> allows you to enter Setup.

Press the  key to enter Setup:

## Legends

Key	Function
	Moves the highlight left or right to select a menu.
	Moves the highlight up or down between sub-menus or fields.
	Exits the BIOS Setup Utility.
	Scrolls forward through the values or options of the highlighted field.
	Scrolls backward through the values or options of the highlighted field.
	Selects a field.
	Displays General Help.
	Load previous values.
	Load optimized default values.
	Saves and exits the Setup program.
	Press <Enter> to enter the highlighted sub-menu

## Scroll Bar

When a scroll bar appears to the right of the setup screen, it indicates that there are more available fields not shown on the screen. Use the up and down arrow keys to scroll through all the available fields.

## Submenu

When “▶” appears on the left of a particular field, it indicates that a submenu which contains additional options are available for that field. To display the submenu, move the highlight to that field and press  .

## BIOS Setup Utility

Once you enter the AMI BIOS Setup Utility, the Main Menu will appear on the screen. The main menu allows you to select from several setup functions and one exit. Use arrow keys to select among the items and press  to accept or enter the submenu.

### Main

The Main menu is the first screen that you will see when you enter the BIOS Setup Utility.

### System Date

The date format is <day>, <month>, <date>, <year>. Day displays a day, from Monday to Sunday. Month displays the month, from January to December. Date displays the date, from 1 to 31. Year displays the year, from 1999 to 2099.

### System Time

The time format is <hour>, <minute>, <second>. The time is based on the 24-hour military-time clock. For example, 1 p.m. is 13:00:00. Hour displays hours from 00 to 23. Minute displays minutes from 00 to 59. Second displays seconds from 00 to 59.



The screenshot shows the Aptio Setup Utility Main menu. The title bar reads "Aptio Setup Utility - Copyright (C) 2013 American Megatrends, Inc." Below the title bar are navigation tabs: Main, Advanced, Chipset, Security, Boot, and Save & Exit. The main area is divided into sections: BIOS Information, CPU Configuration, Memory Information, and System Date/Time. The System Date and Time are currently set to [Tue 07/09/2019] and [12:01:07]. A legend on the right side of the screen provides instructions for navigating the menu.

Aptio Setup Utility - Copyright (C) 2013 American Megatrends, Inc.	
Main    Advanced    Chipset    Security    Boot    Save & Exit	
<b>BIOS Information</b>	
BIOS Vendor	American Megatrends
Core Version	5.009
Compliancy	UEFI 2.3; PI 1.2
Project Version	A200A007 x64
Build Date and Time	10/24/2014 12:00:26
<b>CPU Configuration</b>	
Microcode Patch	901
<b>Memory Information</b>	
Total Memory	2048 MB
System Date	[Tue 07/09/2019]
System Time	[12:01:07]

Set the Date. Use Tab to switch between Date elements.

←→: Select Screen  
 ↑↓: Select Item  
 Enter: Select  
 +/-: Change Opt.  
 F1: General Help  
 F2: Previous Values  
 F3: Optimized Defaults  
 F4: Save & Exit  
 ESC: Exit

Version 2.16.1242. Copyright (C) 2013 American Megatrends, Inc.

## Advanced

The Advanced menu allows you to configure your system for basic operation. Some entries are defaults required by the system board, while others, if enabled, will improve the performance of your system or let you set some features according to your preference.



Setting incorrect field values may cause the system to malfunction.



## ACPI Settings

This section is used to configure ACPI Settings.

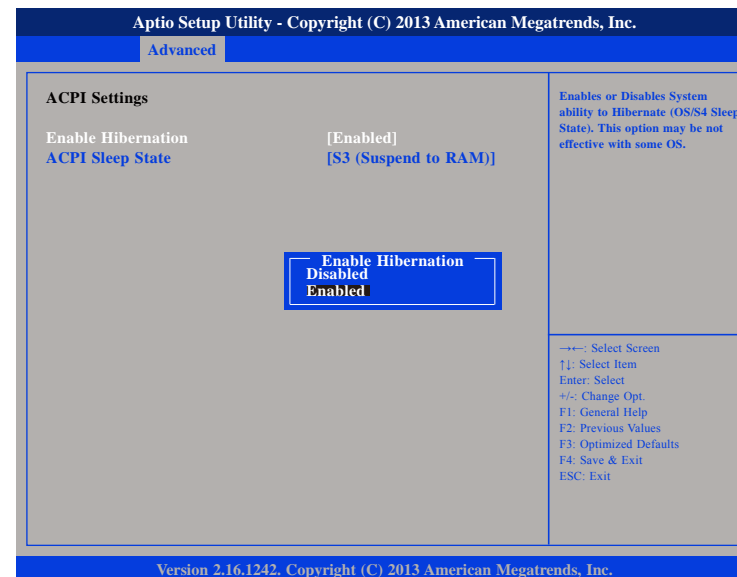

### Enable Hibernation

Enables or disables system ability to hibernate (OS/S4 Sleep State). This option may not be effective with some OS.

## ACPI Sleep State



Select the highest ACPI sleep state the system will enter when the suspend button is pressed. The options are Suspend Disabled and S3 (Suspend to RAM).

## IT8786E Super IO Configuration

This section is used to configure the serial ports.



### Super IO Chip

Displays the Super I/O chip used on the board.

## Serial Port 1 Configuration

This section is used to configure serial port 1.



### Serial Port

Enables or disables the serial port.

### Onboard Serial Port Mode

Select this to change the serial port mode to RS232, RS422, RS485 or RS485 Auto.

### Terminal Resistor

Enables or disables the terminal resistor.

## Serial Port 2 Configuration

This section is used to configure serial port 2.



### Serial Port

Enables or disables the serial port.

### Onboard Serial Port Mode

Select this to change the serial port mode to RS232, RS422, RS485 or RS485 Auto.

### Terminal Resistor

Enables or disables the terminal resistor.



## Hardware Monitor

This section is used to monitor hardware status such as temperature, fan speed and voltages.

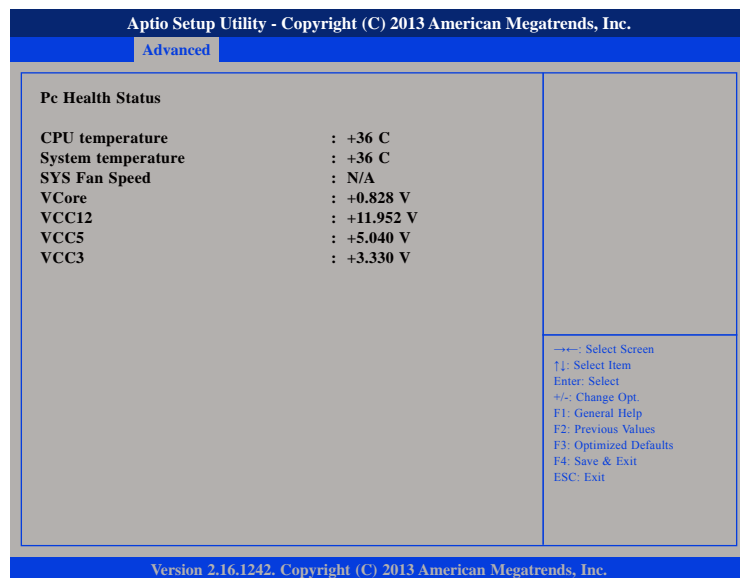

### VCore

Detects and displays the Vcore CPU voltage.

### VCC12

Detects and displays 12V voltage.

### VCC5

Detects and displays 5V voltage.

### VCC3

Detects and displays 3.3V voltage.

### CPU Temperature

Detects and displays the current CPU temperature.

### System Temperature

Detects and displays the current system temperature.

### SYS Fan Speed

Detects and displays the system fan speed.

## CPU Configuration

This section is used to configure the CPU.



### Execute Disable Bit

When this field is set to Disabled, it will force the XD feature flag to always return to 0. XD can prevent certain classes of malicious buffer overflow attacks when combined with a supporting OS (Windows Server 2003 SP1, Windows XP SP2, SuSE Linux 9.2, RedHat Enterprise 3 Update 3).

### Intel® Virtualization Technology

Enables or disables Intel Virtualization technology.

### Active Processors Cores

Select the number of cores to enable in each processor package.

### Limit CPUID Maximum

The CPUID instruction of some newer CPUs will return a value greater than 3. The default is Disabled because this problem does not exist in the Windows series operating systems. If you are using an operating system other than Windows, this problem may occur. To avoid this problem, enable this field to limit the return value to 3 or lesser than 3.

## Socket 0 CPU Information

Display information on the CPU installed on socket 0.

Aptio Setup Utility - Copyright (C) 2013 American Megatrends, Inc.

Advanced

Socket 0 CPU Information	
Intel(R) Atom(TM) CPU E3826 @ 1.46GHz	
CPU Signature	30679
Microcode Patch	901
Max CPU Speed	1460 MHz
Min CPU Speed	533 MHz
Processor Cores	2
Intel HT Technology	Not Supported
Intel VT-x Technology	Supported
L1 Data Cache	24 kB x 2
L1 Code Cache	32 kB x 2
L2 Cache	512 kB x 1
L3 Cache	Not Present

→←: Select Screen  
↑↓: Select Item  
Enter: Select  
+/-: Change Opt.  
F1: General Help  
F2: Previous Values  
F3: Optimized Defaults  
F4: Save & Exit  
ESC: Exit

Version 2.16.1242. Copyright (C) 2013 American Megatrends, Inc.

## PPM Configuration

This section is used to configure the Processor Power Management (PPM) configuration.

Aptio Setup Utility - Copyright (C) 2013 American Megatrends, Inc.

Advanced

PPM Configuration		Enable/Disable Intel SpeedStep
EIST	[Disabled]	

→←: Select Screen  
↑↓: Select Item  
Enter: Select  
+/-: Change Opt.  
F1: General Help  
F2: Previous Values  
F3: Optimized Defaults  
F4: Save & Exit  
ESC: Exit

Version 2.16.1242. Copyright (C) 2013 American Megatrends, Inc.

### EIST

Enables or disables Intel® SpeedStep.

## IDE Configuration

This section is used to configure the SATA drives.



### Serial-ATA (SATA)

Enables or disables the SATA controller.

### SATA Speed Support

Configures the SATA controller as Gen1 or Gen2.

### SATA Mode

Configures the SATA as IDE or AHCI mode.

**IDE** This option configures the Serial ATA drives as Parallel ATA physical storage device.

**AHCI** This option configures the Serial ATA drives to use AHCI (Advanced Host Controller Interface). AHCI allows the storage driver to enable the advanced Serial ATA features which will increase storage performance.

### Serial-ATA Port 0

Enables or disables SATA port 0.

### SATA Port0 HotPlug

Enables or disables hot pluggable support on SATA port 0.

### Serial-ATA Port 1

Enables or disables SATA port 1.

### SATA Port1 HotPlug

Enables or disables hot pluggable support on SATA port 1.

## USB Configuration

This section is used to configure the USB.



Troubleshooting: When installing Windows 7 from USB, USB 3.0 will not be supported. Please disable XHCI and enable EHCI to allow USB installation of Windows 7.



### Legacy USB Support

Enable Enables Legacy USB.

Auto Disables support for Legacy when no USB devices are connected.

Disable Keeps USB devices available only for EFI applications.

### USB3.0 Support

Enables or disables USB 3.0 controller support.

### XHCI Hand-off and EHCI Hand-off

This is a workaround for OSs that does not support XHCI hand-off and EHCI Hand-off. The XHCI and EHCI ownership change should be claimed by the XHCI and EHCI driver respectively.

## Chipset

This section gives you functions to configure the system based on the specific features of the chipset. The chipset manages bus speeds and access to system memory resources.

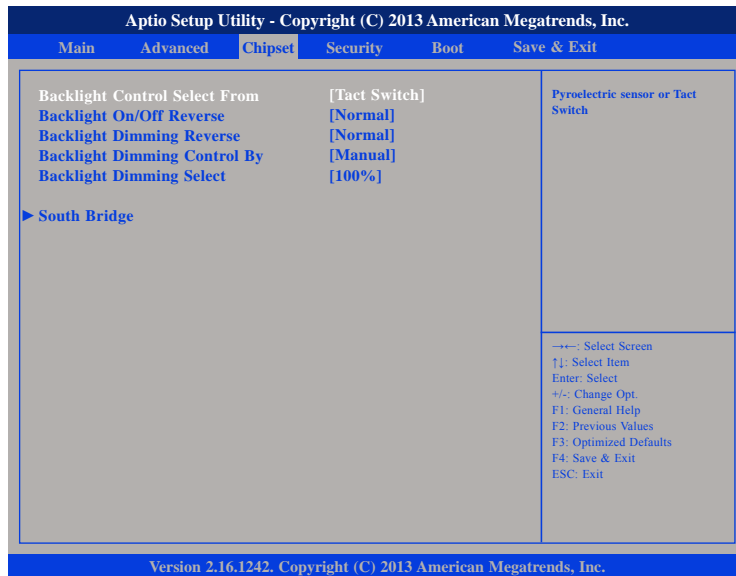

### Backlight Control Select From

The available options are Pyroelectric sensor and Tact Switch.

### Backlight On/Off Reverse

Enables or disables reverse backlight On/Off. Please configure this option only when changing the panel, otherwise the display may not work.

### Backlight Dimming Reverse

The available options are PWM & Analog Dimming Reverse and Normal.

### Backlight Dimming Control By

The available options are Tact Switch, Manual and Light sensor.

### Backlight Dimming Select

Adjusts the brightness of the backlight.

### South Bridge

Enters the South Bridge submenu.

## South Bridge



### High Precision Timer

Enables or disables high precision event timer.

### Restore AC Power Loss

Select the AC power state when power is re-applied after a power failure.

## PCH Azalia Configuration



### Azalia

Control detection of the Azalia device.

Disabled	Azalia will be unconditionally Disabled.
Enabled	Azalia will be unconditionally Enabled.

### Azalia HDMI Codec

Enables or disables internal HDMI codec for Azalia.

## USB Configuration

Aptio Setup Utility - Copyright (C) 2013 American Megatrends, Inc.		
Chipset		
<b>USB Configuration</b>		Control the USB EHCI (USB 2.0) functions. One EHCI controller must always be enabled
XHCI Mode	[Disabled]	
USB 2.0(EHCI) Support	[Enabled]	
USB RMH Mode	[Enabled]	
USB EHCI debug	[Disabled]	
		→←: Select Screen ↑↓: Select Item Enter: Select +/-: Change Opt. F1: General Help F2: Previous Values F3: Optimized Defaults F4: Save & Exit ESC: Exit
Version 2.16.1242. Copyright (C) 2013 American Megatrends, Inc.		

### USB 2.0(EHCI) Support

Enables or disables the Enhanced Host Controller Interface (USB 2.0), one EHCI controller must always be enabled.

### USB RMH Mode

Enables or disables PCH USB rate matching hubs mode.

### USB EHCI Debug

Enables or disables PCH EHCI debug capability.

## PCI Express Configuration

Aptio Setup Utility - Copyright (C) 2013 American Megatrends, Inc.		
Chipset		
<b>PCI Express Configuration</b>		Enable or Disable the PCI Express Port 0 in the Chipset.
PCI Express Port 0	[Enabled]	
PCI Express Port 1	[Enabled]	
PCI Express Port 2	[Enabled]	
PCI Express Port 3	[Enabled]	
		→←: Select Screen ↑↓: Select Item Enter: Select +/-: Change Opt. F1: General Help F2: Previous Values F3: Optimized Defaults F4: Save & Exit ESC: Exit
Version 2.16.1242. Copyright (C) 2013 American Megatrends, Inc.		

### PCI Express Port 0 to PCI Express Port 3

Enables or disables the PCI Express ports 0 to 3 on the chipset.



## Security

Aptio Setup Utility - Copyright (C) 2013 American Megatrends, Inc.

Main Advanced Chipset **Security** Boot Save & Exit

**Password Description**

If ONLY the Administrator's password is set, then this only limits access to Setup and is only asked for when entering Setup. If ONLY the User's password is set, then this is a power on password and must be entered to boot or enter Setup. In Setup the User Will have Administrator rights. The password length must be in the following range:

Minimum length	3
Maximum length	20

Administrator Password  
User Password

Set Administrator Password

←→: Select Screen  
↑↓: Select Item  
Enter: Select  
+/-: Change Opt.  
F1: General Help  
F2: Previous Values  
F3: Optimized Defaults  
F4: Save & Exit  
ESC: Exit

Version 2.16.1242. Copyright (C) 2013 American Megatrends, Inc.

### Administrator Password

Select this to reconfigure the administrator's password.

### User Password

Select this to reconfigure the user's password.

## Boot

This section is used to configure the boot features.

Aptio Setup Utility - Copyright (C) 2013 American Megatrends, Inc.

Main Advanced Chipset Security **Boot** Save & Exit

**Boot Configuration**

Bootup NumLock State	[On]	Select the keyboard NumLock state
Fast Boot	[Disabled]	

**Network**

Onboard LAN PXE	[Enabled]	
	[Disabled]	

**Boot Option Priorities**

Boot Option #1	[SATA PM: TOSHIBA M. . .]
Boot Option #2	[UEFI: Built-in EFI . . .]

**Hard Drive BBS Priorities**

←→: Select Screen  
↑↓: Select Item  
Enter: Select  
+/-: Change Opt.  
F1: General Help  
F2: Previous Values  
F3: Optimized Defaults  
F4: Save & Exit  
ESC: Exit

Version 2.16.1242. Copyright (C) 2013 American Megatrends, Inc.

### Bootup NumLock State

This allows you to determine the default state of the numeric keypad. By default, the system boots up with NumLock on wherein the function of the numeric keypad is the number keys. When set to Off, the function of the numeric keypad is the arrow keys.

### Fast Boot

When enabled, the BIOS will shorten or skip some check items during POST. This will decrease the time needed to boot the system.

## Network

Controls the execution of UEFI and legacy PXE OpROM.

## Onboard LAN PXE

Options to disable onboard LAN PXE ROM or enable it for LAN1 or LAN2 .

## Boot Option Priorities

Adjust the boot sequence of the system. Boot Option #1 is the first boot device that the system will boot from, next will be #2 and so forth.

## Hard Drive BBS Priorities

Sets the order of the legacy devices in this group.



## Save & Exit



### Save Changes and Reset

To save the changes and reset, select this field then press <Enter>. A dialog box will appear. Confirm by selecting Yes.

### Discard Changes and Reset

To exit the Setup utility without saving the changes, select this field then press <Enter>. You may be prompted to confirm again before exiting.

### Restore Defaults

To restore the BIOS to default settings, select this field then press <Enter>. A dialog box will appear. Confirm by selecting Yes.