



**NEXCOM International Co., Ltd.**

# **Network and Communication Solutions**

## **Network Security Appliance**

### **NSA 7136**

#### User Manual

# CONTENTS

## Preface

Copyright .....	iv
Disclaimer .....	iv
Acknowledgements .....	iv
Regulatory Compliance Statements .....	iv
Declaration of Conformity .....	iv
RoHS Compliance .....	v
Warranty and RMA .....	vi
Safety Information .....	viii
Installation Recommendations .....	viii
Safety Precautions .....	ix
Technical Support and Assistance .....	x
Conventions Used in this Manual .....	x
Global Service Contact Information .....	xi
Package Contents .....	xiii
Ordering Information .....	xiv

## Chapter 1: Product Introduction

Overview .....	1
Key Features .....	1
Hardware Specifications .....	2
Knowing Your NSA 7136 .....	3
Front Panel .....	3
Rear Panel .....	4

## Chapter 2: Jumpers and Connectors

Before You Begin .....	5
Precautions .....	5
Jumper Settings .....	6
Locations of the Jumpers and Connectors .....	7
Jumpers .....	8
TPM Select .....	8
RTC Clear .....	8
ME Firmware Update .....	9
Password Clear .....	9
BIOS Recovery .....	10
Watchdog Setting .....	10
Console Type Selection (RTS/CTS) .....	11
Console Type Selection (RTS/CTS) .....	11
Connector Pin Definitions .....	12
External Connectors .....	12
System Reset Button .....	12
RJ45 Console Port .....	12
Internal Connectors .....	13
VGA Connector .....	13
SATA Connectors .....	13
LCM Header .....	14
USB Headers .....	14
Fan Headers .....	15
ATX Connector .....	15
ATX Connector .....	16

PCIe Slots.....	17
Block Diagram .....	19

## Chapter 3: System Setup

Removing the Chassis Cover .....	20
Installing an External SATA Hard Drive.....	21
Installing a LAN Module.....	23
Installing the Rackmount Rails.....	25

## Chapter 4: BIOS Setup

About BIOS Setup.....	27
When to Configure the BIOS.....	27
Default Configuration .....	28
Entering Setup.....	28
Legends.....	28
BIOS Setup Utility.....	30
Main .....	30
Advanced .....	31
Intel RC Setup .....	39
Security .....	50
Boot.....	50
Save & Exit .....	51

# PREFACE

## Copyright

This publication, including all photographs, illustrations and software, is protected under international copyright laws, with all rights reserved. No part of this manual may be reproduced, copied, translated or transmitted in any form or by any means without the prior written consent from NEXCOM International Co., Ltd.

## Disclaimer

The information in this document is subject to change without prior notice and does not represent commitment from NEXCOM International Co., Ltd. However, users may update their knowledge of any product in use by constantly checking its manual posted on our website: <http://www.nexcom.com>. NEXCOM shall not be liable for direct, indirect, special, incidental, or consequential damages arising out of the use of any product, nor for any infringements upon the rights of third parties, which may result from such use. Any implied warranties of merchantability or fitness for any particular purpose is also disclaimed.

## Acknowledgements

NSA 7136 is a trademark of NEXCOM International Co., Ltd. All other product names mentioned herein are registered trademarks of their respective owners.

## Regulatory Compliance Statements

This section provides the FCC compliance statement for Class A devices and describes how to keep the system CE compliant.

## Declaration of Conformity

### FCC

This equipment has been tested and verified to comply with the limits for a Class A digital device, pursuant to Part 15 of FCC Rules. These limits are designed to provide reasonable protection against harmful interference when the equipment is operated in a commercial environment. This equipment generates, uses, and can radiate radio frequency energy and, if not installed and used in accordance with the instructions, may cause harmful interference to radio communications. Operation of this equipment in a residential area (domestic environment) is likely to cause harmful interference, in which case the user will be required to correct the interference (take adequate measures) at their own expense.

### CE

The product(s) described in this manual complies with all applicable European Union (CE) directives if it has a CE marking. For computer systems to remain CE compliant, only CE-compliant parts may be used. Maintaining CE compliance also requires proper cable and cabling techniques.

## RoHS Compliance



### **NEXCOM RoHS Environmental Policy and Status Update**

NEXCOM is a global citizen for building the digital infrastructure. We are committed to providing green products and services, which are compliant with European Union RoHS (Restriction on Use of Hazardous Substance in Electronic Equipment) directive 2011/65/EU, to be your trusted green partner and to protect our environment.

RoHS restricts the use of Lead (Pb) < 0.1% or 1,000ppm, Mercury (Hg) < 0.1% or 1,000ppm, Cadmium (Cd) < 0.01% or 100ppm, Hexavalent Chromium (Cr6+) < 0.1% or 1,000ppm, Polybrominated biphenyls (PBB) < 0.1% or 1,000ppm, and Polybrominated diphenyl Ethers (PBDE) < 0.1% or 1,000ppm.

In order to meet the RoHS compliant directives, NEXCOM has established an engineering and manufacturing task force in to implement the introduction of green products. The task force will ensure that we follow the standard NEXCOM development procedure and that all the new RoHS components and new manufacturing processes maintain the highest industry quality levels for which NEXCOM are renowned.

The model selection criteria will be based on market demand. Vendors and suppliers will ensure that all designed components will be RoHS compliant.

### **How to recognize NEXCOM RoHS Products?**

For existing products where there are non-RoHS and RoHS versions, the suffix "(LF)" will be added to the compliant product name.

All new product models launched after January 2013 will be RoHS compliant. They will use the usual NEXCOM naming convention.

## Warranty and RMA

### NEXCOM Warranty Period

NEXCOM manufactures products that are new or equivalent to new in accordance with industry standard. NEXCOM warrants that products will be free from defect in material and workmanship for 2 years, beginning on the date of invoice by NEXCOM. HCP series products (Blade Server) which are manufactured by NEXCOM are covered by a three year warranty period.

### NEXCOM Return Merchandise Authorization (RMA)

- Customers shall enclose the “NEXCOM RMA Service Form” with the returned packages.
- Customers must collect all the information about the problems encountered and note anything abnormal or, print out any on-screen messages, and describe the problems on the “NEXCOM RMA Service Form” for the RMA number apply process.
- Customers can send back the faulty products with or without accessories (manuals, cable, etc.) and any components from the card, such as CPU and RAM. If the components were suspected as part of the problems, please note clearly which components are included. Otherwise, NEXCOM is not responsible for the devices/parts.
- Customers are responsible for the safe packaging of defective products, making sure it is durable enough to be resistant against further damage and deterioration during transportation. In case of damages occurred during transportation, the repair is treated as “Out of Warranty.”
- Any products returned by NEXCOM to other locations besides the customers’ site will bear an extra charge and will be billed to the customer.

### Repair Service Charges for Out-of-Warranty Products

NEXCOM will charge for out-of-warranty products in two categories, one is basic diagnostic fee and another is component (product) fee.

### Repair Service Charges for Out-of-Warranty Products

NEXCOM will charge for out-of-warranty products in two categories, one is basic diagnostic fee and another is component (product) fee.

### System Level

- Component fee: NEXCOM will only charge for main components such as SMD chip, BGA chip, etc. Passive components will be repaired for free, ex: resistor, capacitor.
- Items will be replaced with NEXCOM products if the original one cannot be repaired. Ex: motherboard, power supply, etc.
- Replace with 3rd party products if needed.
- If RMA goods can not be repaired, NEXCOM will return it to the customer without any charge.

### Board Level

- Component fee: NEXCOM will only charge for main components, such as SMD chip, BGA chip, etc. Passive components will be repaired for free, ex: resistors, capacitors.
- If RMA goods can not be repaired, NEXCOM will return it to the customer without any charge.

## Warnings

Read and adhere to all warnings, cautions, and notices in this guide and the documentation supplied with the chassis, power supply, and accessory modules. If the instructions for the chassis and power supply are inconsistent with these instructions or the instructions for accessory modules, contact the supplier to find out how you can ensure that your computer meets safety and regulatory requirements.

## Cautions

Electrostatic discharge (ESD) can damage system components. Do the described procedures only at an ESD workstation. If no such station is available, you can provide some ESD protection by wearing an antistatic wrist strap and attaching it to a metal part of the computer chassis.

## Safety Information

Before installing and using the device, note the following precautions:

- Read all instructions carefully.
- Do not place the unit on an unstable surface, cart, or stand.
- Follow all warnings and cautions in this manual.
- When replacing parts, ensure that your service technician uses parts specified by the manufacturer.
- Avoid using the system near water, in direct sunlight, or near a heating device.
- The load of the system unit does not solely rely for support from the rackmounts located on the sides. Firm support from the bottom is highly necessary in order to provide balance stability.
- The computer is provided with a battery-powered real-time clock circuit. There is a danger of explosion if battery is incorrectly replaced. Replace only with the same or equivalent type recommended by the manufacturer. Discard used batteries according to the manufacturer's instructions.

## Installation Recommendations

Ensure you have a stable, clean working environment. Dust and dirt can get into components and cause a malfunction. Use containers to keep small components separated.

Adequate lighting and proper tools can prevent you from accidentally damaging the internal components. Most of the procedures that follow require only a few simple tools, including the following:

- A Philips screwdriver
- A flat-tipped screwdriver
- A grounding strap
- An anti-static pad

Using your fingers can disconnect most of the connections. It is recommended that you do not use needle-nose pliers to disconnect connections as these can damage the soft metal or plastic parts of the connectors.



## Safety Precautions

1. Read these safety instructions carefully.
2. Keep this User Manual for later reference.
3. Disconnect this equipment from any AC outlet before cleaning. Use a damp cloth. Do not use liquid or spray detergents for cleaning.
4. For plug-in equipment, the power outlet socket must be located near the equipment and must be easily accessible.
5. Keep this equipment away from humidity.
6. Put this equipment on a stable surface during installation. Dropping it or letting it fall may cause damage.
7. The openings on the enclosure are for air convection to protect the equipment from overheating. **DO NOT COVER THE OPENINGS.**
8. Make sure the voltage of the power source is correct before connecting the equipment to the power outlet.
9. Place the power cord in a way so that people will not step on it. Do not place anything on top of the power cord. Use a power cord that has been approved for use with the product and that it matches the voltage and current marked on the product's electrical range label. The voltage and current rating of the cord must be greater than the voltage and current rating marked on the product.
10. All cautions and warnings on the equipment should be noted.
11. If the equipment is not used for a long time, disconnect it from the power source to avoid damage by transient overvoltage.
12. Never pour any liquid into an opening. This may cause fire or electrical shock.
13. Never open the equipment. For safety reasons, the equipment should be opened only by qualified service personnel.
14. If one of the following situations arises, get the equipment checked by service personnel:
  - a. The power cord or plug is damaged.
  - b. Liquid has penetrated into the equipment.
  - c. The equipment has been exposed to moisture.
  - d. The equipment does not work well, or you cannot get it to work according to the user's manual.
  - e. The equipment has been dropped and damaged.
  - f. The equipment has obvious signs of breakage.
15. Do not place heavy objects on the equipment.
16. The unit uses a three-wire ground cable which is equipped with a third pin to ground the unit and prevent electric shock. Do not defeat the purpose of this pin. If your outlet does not support this kind of plug, contact your electrician to replace your obsolete outlet.
17. **CAUTION: DANGER OF EXPLOSION IF BATTERY IS INCORRECTLY REPLACED. REPLACE ONLY WITH THE SAME OR EQUIVALENT TYPE RECOMMENDED BY THE MANUFACTURER. DISCARD USED BATTERIES ACCORDING TO THE MANUFACTURER'S INSTRUCTIONS.**

## Technical Support and Assistance

1. For the most updated information of NEXCOM products, visit NEXCOM's website at [www.nexcom.com](http://www.nexcom.com).
2. For technical issues that require contacting our technical support team or sales representative, please have the following information ready before calling:
  - Product name and serial number
  - Detailed information of the peripheral devices
  - Detailed information of the installed software (operating system, version, application software, etc.)
  - A complete description of the problem
  - The exact wordings of the error messages

### Warning!

1. Handling the unit: carry the unit with both hands and handle it with care.
2. Maintenance: to keep the unit clean, use only approved cleaning products or clean with a dry cloth.

## Conventions Used in this Manual



### Warning:

Information about certain situations, which if not observed, can cause personal injury. This will prevent injury to yourself when performing a task.



### Caution:

Information to avoid damaging components or losing data.



### Note:

Provides additional information to complete a task easily.

## Global Service Contact Information

### Headquarters

#### NEXCOM International Co., Ltd.

9F, No. 920, Chung-Cheng Rd.,  
ZhongHe District, New Taipei City, 23586,  
Taiwan, R.O.C.

Tel: +886-2-8226-7786

Fax: +886-2-8226-7782

www.nexcom.com

### America

#### USA

#### NEXCOM USA

2883 Bayview Drive,  
Fremont CA 94538, USA

Tel: +1-510-656-2248

Fax: +1-510-656-2158

Email: sales@nexcom.com

www.nexcom.com

### Asia

#### Taiwan

#### NEXCOM Intelligent Systems

#### Taipei Office

13F, No.920, Chung-Cheng Rd.,  
ZhongHe District,  
New Taipei City, 23586, Taiwan, R.O.C.

Tel: +886-2-8226-7796

Fax: +886-2-8226-7792

Email: sales@nexcom.com.tw

www.nexcom.com.tw

### NEXCOM Intelligent Systems

#### Taichung Office

16F, No.250, Sec. 2, Chongde Rd.,  
Beitun Dist.,

Taichung City 406, R.O.C.

Tel: +886-4-2249-1179

Fax: +886-4-2249-1172

Email: sales@nexcom.com.tw

www.nexcom.com.tw

### Japan

#### NEXCOM Japan

9F, Tamachi Hara Bldg.,  
4-11-5, Shiba Minato-ku,  
Tokyo, 108-0014, Japan

Tel: +81-3-5419-7830

Fax: +81-3-5419-7832

Email: sales@nexcom-jp.com

www.nexcom-jp.com

### China

#### NEXCOM China

Floor 5, No.4, No.7 fengxian middle Rd.,  
(Beike Industrial Park), Haidian District,  
Beijing, 100094, China

Tel: +86-10-5704-2680

Fax: +86-10-5704-2681

Email: sales@nexcom.cn

www.nexcom.cn

**NEXCOM Shanghai**

Room 603/604, Huiyinmingzun Plaza Bldg., 1,  
No.609, Yunlin East Rd.,  
Shanghai, 200333, China  
Tel: +86-21-5278-5868  
Fax: +86-21-3251-6358  
Email: sales@nexcom.cn  
www.nexcom.cn

**NEXCOM Surveillance Technology Corp.**

Room202, Building B,  
the GuangMing Industrial Zone Zhonghua Rd.,  
Minzhi Street, Longhua District,  
Shenzhen 518131, China  
Tel: +86-755-8364-7768  
Fax: +86-755-8364-7738  
Email: steveyang@nexcom.com.tw  
www.nexcom.cn

**NEXCOM United System Service**

Hui Yin Ming Zun Building Room 1108,  
Building No. 11, 599 Yunling Road, Putuo District,  
Shanghai, 200062, China  
Tel: +86-21-6125-8282  
Fax: +86-21-6125-8281  
Email: frankyang@nexcom.cn  
www.nexcom.cn

**Europe****United Kingdom****NEXCOM EUROPE**

10 Vincent Avenue,  
Crownhill Business Centre,  
Milton Keynes, Buckinghamshire  
MK8 0AB, United Kingdom  
Tel: +44-1908-267121  
Fax: +44-1908-262042  
Email: sales.uk@nexcom.eu  
www.nexcom.eu

**Italy****NEXCOM ITALIA S.r.l**

Via Lanino 42,  
21047 Saronno (VA), Italia  
Tel: +39 02 9628 0333  
Fax: +39 02 9625 570  
Email: nexcomitalia@nexcom.eu  
www.nexcomitalia.it

## Package Contents

Before continuing, verify that the NSA 7136 package that you received is complete. Your package should have all the items listed in the following table.

Item	Part Number	Name	Description	Qty
1	19S00713600X0	NSA 7136		1
2	50311F0095X00	Flat Head Screw Long Fei:F6#32Tx5 Nylok NIGP	F6#32Tx5 NI Nylok	4
3	50311F0100X00	Round Head Screw w/Spring+Flat Washer Long Fei:P3x6L	P3x6 iso/SW6x0.5 NI	1
4	50311F0162X00	Round Head Screw w/Washer Long Fei	P4x8 iso/w NI	1
5	50311F0512X00	F Head Screw Long Fei:F2.5x6L ISO Black+Nylok	F2.5x6L ISO Black+Nylok	8
6	5040150001X00	NSA 7135 AL Handle VER:A Panadvance	78x58x8mm	1
7	5044440031X00	Rubber Foot Kang Yang:RF20-5-4P	19.8x18x5.0mm	4
8	6012200052X00	PE Zipper Bag #8	170x240mm, w/China RoHS Symbol	1
9	6012200053X00	PE Zipper Bag #3	100x70mm, w/China RoHS Symbol	1
10	6023309081X00	Cable EDI: 232091081804-RS	COM Port. DB9 Female to RJ45 8P8C L:1800mm	1

## Ordering Information

The following information below provides ordering information for NSA 7136.

### Barebone

#### NSA 7136 (P/N: 10S00713600X0)

2U Intel® Xeon® E5-2600 v4/v3 PCH C612, with LCM, 1 swappable 3.5" HDD tray, 3 swappable system fans, 8 LAN module (NI/NX series) bays, 700W PSU

### LAN Modules

Model	P/N	Interface	Type	Port Number	Bypass/Segment	Expansion Slot	Location Slot
<b>NX 140F</b>	10S20140F01X0	XL710-AM1	PCIe x8	4 SFP+	None	None	All Slot
<b>NX 142F</b>	10S20142F01X0	XL710-AM1	PCIe x8	4 SFP+	2 bypass	None	All Slot
<b>NX 142F-LR</b>	10S20142F03X0	XL710-BM1	PCIe x8	4 SFP+	2 bypass	None	All Slot
<b>NX 120F</b>	10S20120F00X0	X710-BM2	PCIe x8	2 SFP+	None	None	All Slot
<b>NI 140F</b>	10SK000NI02X0	i350AM4x1	PCIe x8	4 SFP	None	None	All Slot
<b>NI 180F</b>	10S10180F01X0	i350AM4x2	PCIe x8	8 SFP	None	None	All Slot
<b>NI 142C</b>	10SK000NI03X0	i350AM4x1	PCIe x8	4 Copper	2 bypass	None	All Slot
<b>NI 180C</b>	10S10180C01X0	i350AM4x2	PCIe x8	8 Copper	None	None	All Slot
<b>NI 184C</b>	10S10184C01X0	i350AM4x2	PCIe x8	8 Copper	4 bypass	None	All Slot
<b>NI 142F</b>	10S10142F01X0	i350AM4x1	PCIe x8	4 SFP	2 bypass	None	All Slot
<b>NI 121F</b>	10S10121F01X0	i350AM2x1	PCIe x8	2 SFP	1 bypass	None	All Slot
<b>NI 140C</b>	10S10140C01X0	i350AM4x1	PCIe x8	4 Copper	None	None	All Slot
<b>NV 120F</b>	10S50120F01X0	XXV710-AM2	PCIe x8	2 QSFP	None	None	All Slot
<b>NC220Q28M</b>	10S30022002X0	MT27708A0-FDCF-CE	PCIe x16	2 QSFP28	None	None	1,2/ 3,4/ 5,6/ 7,8

# CHAPTER 1: PRODUCT INTRODUCTION

## Overview



## Key Features

- Dual Intel® Xeon® processor E5-2600 v4/v3 product family
- Support DDR4 1866/2133/2400 ECC & REG, up to 512GB
- Modular design supports 8 LAN module slots
- Support swappable 3.5" SATA/SAS HDD
- Support CRPS (1 + 1) redundant power supply
- Support LCD module

## Hardware Specifications

### Main Board

- NSB 7136
- Dual Intel® Xeon® processor E5-2600 v4/v3 product family
- Support 9.6 GT/s QPI speed
- Intel® C612
- One PCIe x8 expansion slot (Internal)

### LAN Features

- Swappable LAN modules
- Support Intel® i350/ Intel® XL710 Copper/Fiber ports
- Support 10/100/1000/10G link speed
- LAN Bypass: \*\* please see LAN module list information

### I/O Interface-Front

- Support 2 x 20 characters LCD module, SIO interface
- Power status/ HDD status/ GPIO status/ system failure status LEDs
- 1 x 3.5" HDD swappable bays
- 8 x LAN module bays
- 2 x USB 2.0 ports
- 1 x RJ45 type console port
- 1 x Reset button
- 2 x Management LAN ports

### I/O Interface-Rear

- 3 x Swappable system FANs
- 1 x Power button switch
- 1 x VGA Port
- 2 x USB 2.0 ports

### Main Memory

- 16 x 284-pin DDR4 1866/2133/2400 DIMM sockets, up to 512GB ECC & REG SDRAM

### Devices

- 1 x on-board CFast socket

### Power Input

- 700W 1+1 CRPS redundant power supply

### Chassis Dimensions

- Chassis dimension: 432 mm x 550 mm x 88 mm
- Carton dimension: 774 mm x 636 mm x 293 mm

### Weight

- Without packing: 19kg
- With packing: 25kg

### Environment

- Operating temperature: 0°C~40°C
- Storage temperature: -20°C~75°C
- Relative humidity: 10%~90% non-condensing

### Certifications

- CE approval
- FCC Class A
- UL



# Knowing Your NSA 7136

## Front Panel

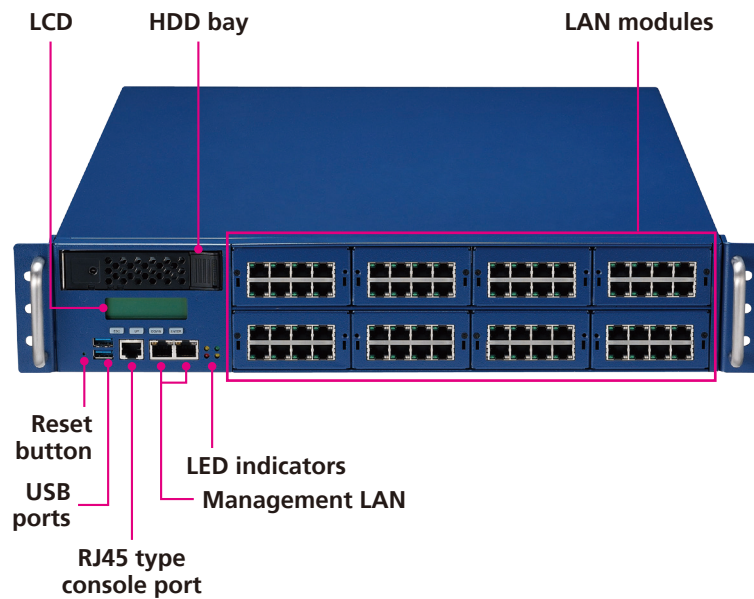

### LCD

2x20 characters LCD module, SIO interface.

### HDD Bay

One 3.5" HDD swappable bay for installing a HDD.

### LAN Modules

Eight LAN module bays.

### Reset Button

Press to restart the system.

### USB Ports

Used to connect USB 2.0/1.1 devices.

### Console Port

Used to connect RJ45 type console port.

### Management LAN Ports

Two LAN ports used for managing the system.

### LED Indicators

Indicates the power, hard drive and GPIO activity of the system.

LED	Color
Power	Green
HDD	Yellow
System Failure	Red
GPIO	Yellow



## Rear Panel

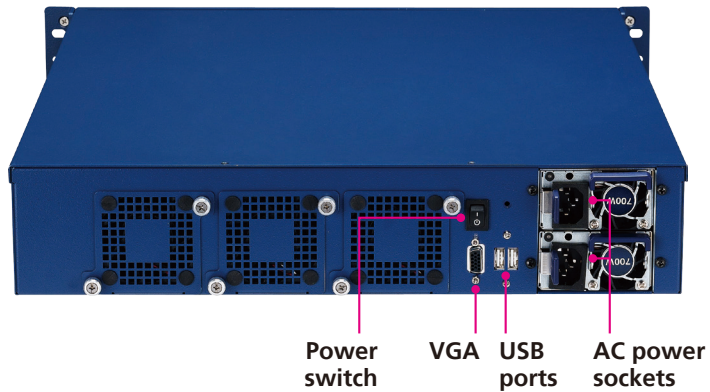

### Power Switch

Press to power-on or power-off the system.

### VGA

Used to connect an analog VGA monitor.

### USB Ports

Used to connect USB 2.0/1.1 devices.

### AC Power Sockets

Dual redundant power supply sockets, plug an AC power cord here before turning on the system.

## CHAPTER 2: JUMPERS AND CONNECTORS

This chapter describes how to set the jumpers and connectors on the NSA 7136 motherboard.

### Before You Begin

- Ensure you have a stable, clean working environment. Dust and dirt can get into components and cause a malfunction. Use containers to keep small components separated.
- Adequate lighting and proper tools can prevent you from accidentally damaging the internal components. Most of the procedures that follow require only a few simple tools, including the following:
  - A Philips screwdriver
  - A flat-tipped screwdriver
  - A set of jewelers screwdrivers
  - A grounding strap
  - An anti-static pad
- Using your fingers can disconnect most of the connections. It is recommended that you do not use needle-nosed pliers to disconnect connections as these can damage the soft metal or plastic parts of the connectors.
- Before working on internal components, make sure that the power is off. Ground yourself before touching any internal components, by touching a metal object. Static electricity can damage many of the electronic components. Humid environments tend to have less static electricity than

dry environments. A grounding strap is warranted whenever danger of static electricity exists.

### Precautions

Computer components and electronic circuit boards can be damaged by discharges of static electricity. Working on computers that are still connected to a power supply can be extremely dangerous.

Follow the guidelines below to avoid damage to your computer or yourself:

- Always disconnect the unit from the power outlet whenever you are working inside the case.
- If possible, wear a grounded wrist strap when you are working inside the computer case. Alternatively, discharge any static electricity by touching the bare metal chassis of the unit case, or the bare metal body of any other grounded appliance.
- Hold electronic circuit boards by the edges only. Do not touch the components on the board unless it is necessary to do so. Don't flex or stress the circuit board.
- Leave all components inside the static-proof packaging that they shipped with until they are ready for installation.
- Use correct screws and do not over tighten screws.

## Jumper Settings

A jumper is the simplest kind of electric switch. It consists of two metal pins and a cap. When setting the jumpers, ensure that the jumper caps are placed on the correct pins. When the jumper cap is placed on both pins, the jumper is short. If you remove the jumper cap, or place the jumper cap on just one pin, the jumper is open.

Refer to the illustrations below for examples of what the 2-pin and 3-pin jumpers look like when they are short (on) and open (off).

Two-Pin Jumpers: Open (Left) and Short (Right)

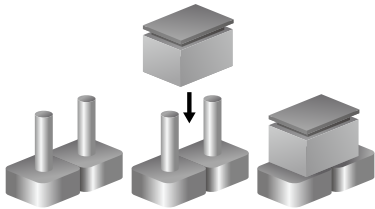

Three-Pin Jumpers: Pins 1 and 2 are Short

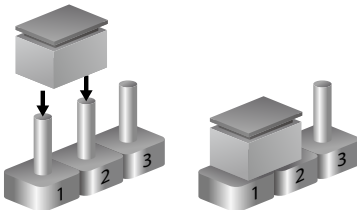

# Locations of the Jumpers and Connectors

The figure below shows the location of the jumpers and connectors.

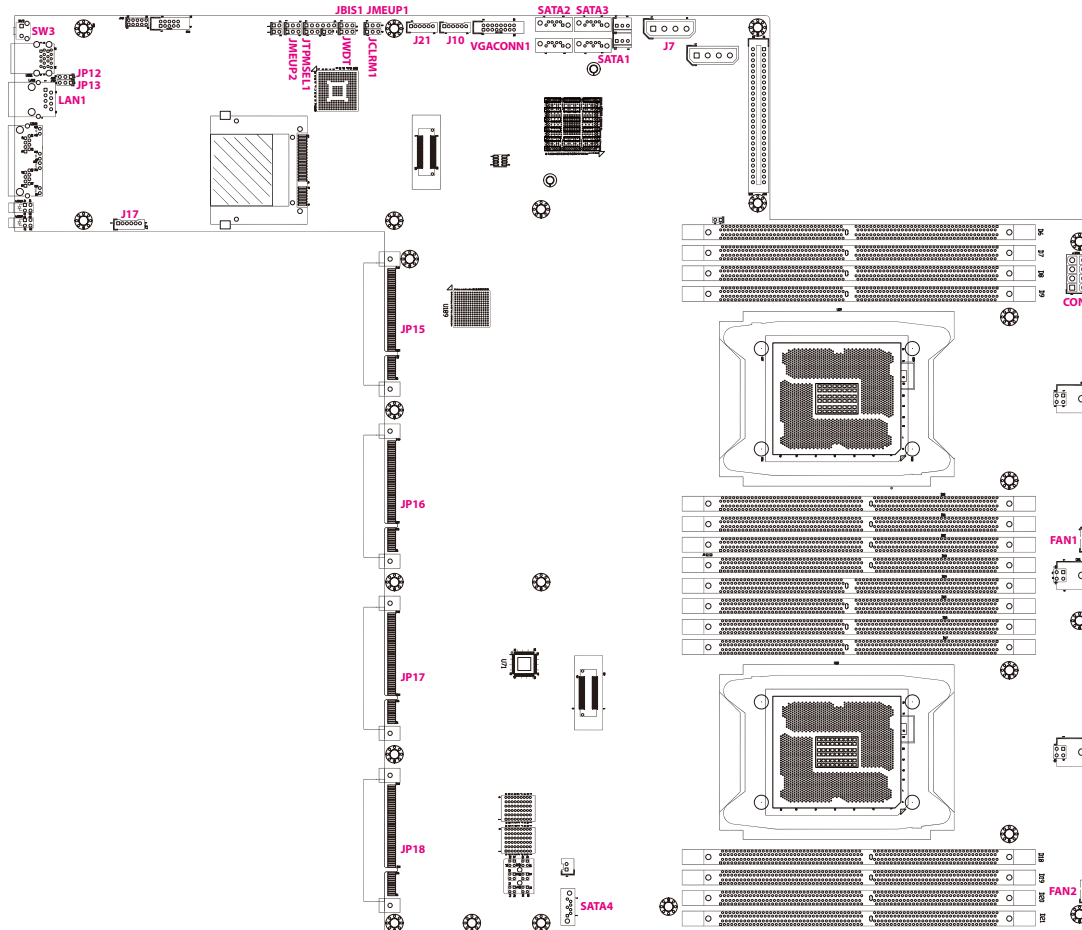

## Jumpers

### TPM Select

Connector type: 1x3 3-pin header, 2.54mm pitch  
Connector location: JTPMSEL1



Pin	Function
1-2 On	Enable some special commands
2-3 On	Disable some special commands

2-3 On: default

### RTC Clear

Connector type: 1x3 3-pin header, 2.54mm pitch  
Connector location: JCLRM1



Pin	Function
1-2 On	Normal
2-3 On	Clear CMOS

1-2 On: default

## ME Firmware Update

Connector type: 1x3 3-pin header, 2.54mm pitch  
Connector location: JMEUP2



Pin	Function
1-2 On	Normal
2-3 On	ME Force Update

1-2 On: default

## Password Clear

Connector type: 1x3 3-pin header, 2.54mm pitch  
Connector location: JMEUP1



Pin	Function
1-2 On	Normal
2-3 On	Password Clear

1-2 On: default

## BIOS Recovery

Connector type: 1x3 3-pin header, 2.54mm pitch

Connector location: JBIS1



Pin	Function
1-2 On	Normal
2-3 On	Recover BIOS

1-2 On: default

## Watchdog Setting

Connector type: 1x3 3-pin header, 2.54mm pitch

Connector location: JWDT



Pin	Function
1-2 On	NC
2-3 On	Reset at WDTO

2-3 On: default



## Console Type Selection (RTS/CTS)

Connector type: 1x3 3-pin header, 2.54mm pitch  
Connector location: JP13



Pin	Function
1-2 On	RTS to CTS
2-3 On	Normal

2-3 On: default

## Console Type Selection (RTS/CTS)

Connector type: 1x3 3-pin header, 2.54mm pitch  
Connector location: JP12



Pin	Function
1-2 On	RTS to CTS
2-3 On	Normal

2-3 On: default

## Connector Pin Definitions

### External Connectors

#### System Reset Button

Connector location: SW3



Pin	Definition
1	GND
2	RST_BTN_N

#### RJ45 Console Port

Connector location: LAN1

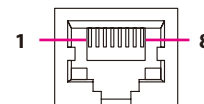

Pin	Definition	Pin	Definition
1	SP_RTS1_R	2	SP_DTR1_R
3	SP_TXD1_R	4	GND
5	SP_DCD1_R	6	SP_RXD1_R
7	SP_DSR1_R	8	SP_CTS1_CON

## Internal Connectors

### VGA Connector

Connector type: 2x8 16-pin header, 2.0mm pitch

Connector location: VGACONN1

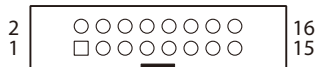

Pin	Definition	Pin	Definition
1	DACROA_B	2	DACGOA_B
3	DACBOA_B	4	NC
5	GND	6	GND
7	GND	8	GND
9	VGA_VCC	10	GND
11	NC	12	DDC_DATAO_B
13	AHSYNCO_B	14	AVSYNCO_B
15	DDC_CLKO_B	16	NC

### SATA Connectors

Connector type: Standard Serial ATA 7P (1.27mm, SATA-M-180)

Connector location: SATA1, SATA2, SATA3 and SATA4

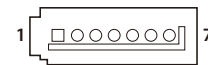

Pin	Definition	Pin	Definition
1	GND	2	TXP
3	TXN	4	GND
5	RXN	6	RXP
7	GND		

## LCM Header

Connector type: 1x6 6-pin header, 2.0mm

Connector location: J17

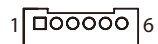

Pin	Definition	Pin	Definition
1	TX	2	RX
3	GND	4	5V
5	LED_KR_N	6	LED_KG_N

## USB Headers

Connector type: 1x6 6-pin header, 2.0mm

Connector location: J10 and J21



Pin	Definition	Pin	Definition
1	5V	2	DN1
3	DP1	4	DN2
5	DP2	6	GND

## Fan Headers

Connector type: 1x4 4-pin Wafer, 2.54mm pitch

Connector location: FAN1 and FAN2



Pin	Definition	Pin	Definition
1	GND	2	P12V
3	FAN_TACH	4	FAN_PWM

## ATX Connector

Connector type: 2x4 8-pin header, 4.2mm pitch

Connector location: CON1

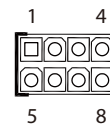

Pin	Definition	Pin	Definition
1	GND	2	GND
3	GND	4	GND
5	12V	6	12V
7	12V	8	12V

## ATX Connector

Connector type: 1x4 4-pin header, 5.08mm pitch

Connector location: J7



Pin	Definition	Pin	Definition
1	12V	2	GND
3	GND	4	5V

## PCIe Slots

Connector location: JP15, JP16, JP17 and JP18



Pin	Definition	Pin	Definition
A1	GND	B1	12V
A2	12V	B2	12V
A3	12V	B3	12V
A4	GND	B4	GND
A5	NC	B5	SMBCLK
A6	NC	B6	SMBDATA
A7	NC	B7	GND
A8	NC	B8	3.3V
A9	3.3V	B9	NC
A10	3.3V	B10	P3V3AUX
A11	PRSNT#	B11	WAKE#
A12	GND	B12	BYPASS_GATE Enable
A13	CLK_P	B13	GND
A14	CLK_N	B14	TX0P
A15	GND	B15	TX0N
A16	RX0P	B16	GND

Pin	Definition	Pin	Definition
A17	RX0N	B17	NC
A18	GND	B18	GND
A19	BYPASS_A Enable	B19	TX1P
A20	GND	B20	TX1N
A21	RX1P	B21	GND
A22	RX1N	B22	GND
A23	GND	B23	TX2P
A24	GND	B24	TX2N
A25	RX2P	B25	GND
A26	RX2N	B26	GND
A27	GND	B27	TX3P
A28	GND	B28	TX3N
A29	RX3P	B29	GND
A30	RX3N	B30	BYPASS_B Enable
A31	GND	B31	NC
A32	BYPASS_C Enable	B32	GND

Pin	Definition	Pin	Definition
A33	BYPASS_D Enable	B33	TX4P
A34	GND	B34	TX4N
A35	RX4P	B35	GND
A36	RX4N	B36	GND
A37	GND	B37	TX5P
A38	GND	B38	TX5N
A39	RX5P	B39	GND
A40	RX5N	B40	GND
A41	GND	B41	TX6P
A42	GND	B42	TX6N
A43	RX6P	B43	GND
A44	RX6N	B44	GND
A45	GND	B45	TX7P
A46	GND	B46	TX7N
A47	RX7P	B47	GND
A48	RX7N	B48	NC
A49	GND	B49	GND



# Block Diagram

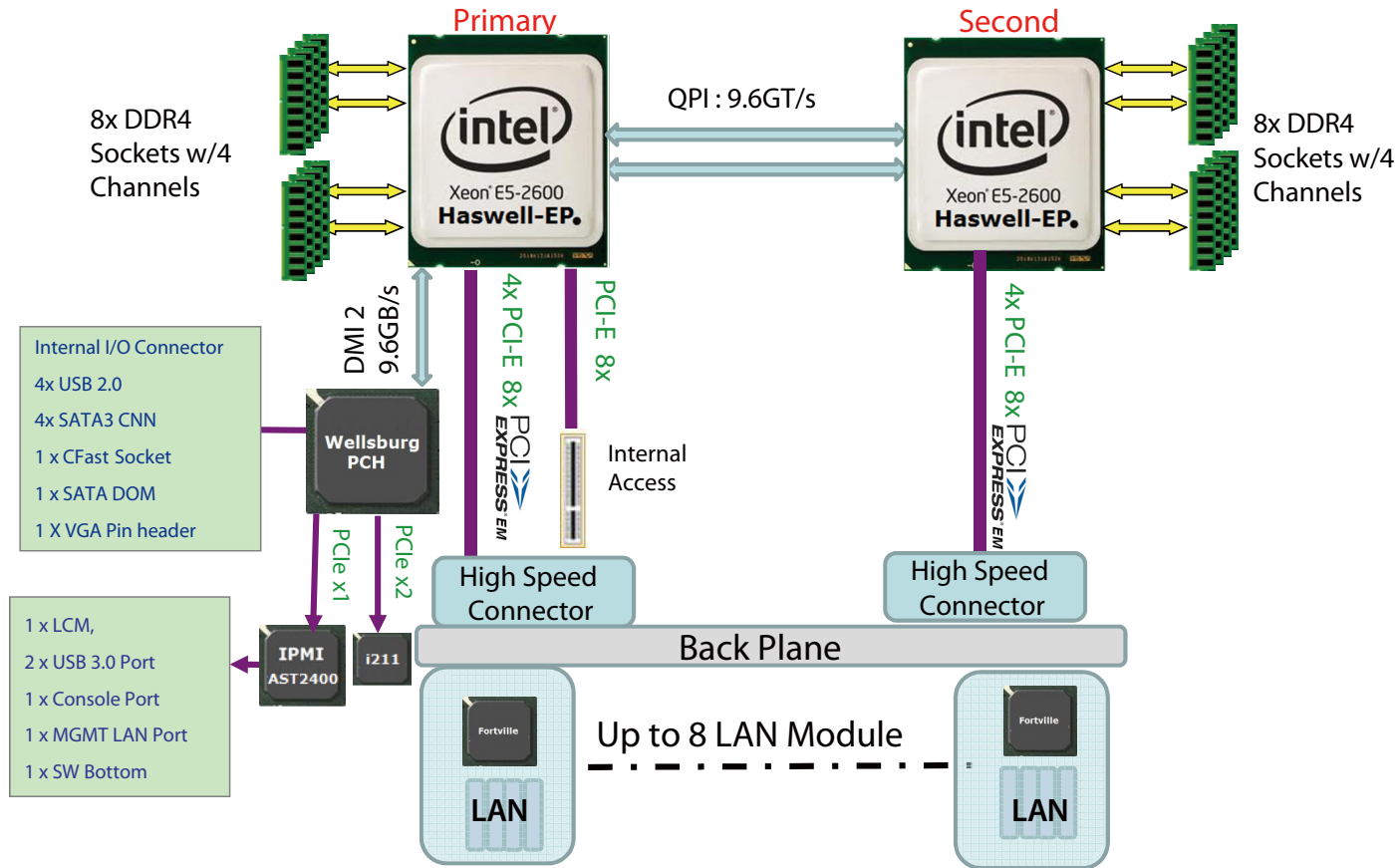

## CHAPTER 3: SYSTEM SETUP

### Removing the Chassis Cover



Prior to removing the chassis cover, make sure the unit's power is off and disconnected from the power sources to prevent electric shock or system damage.

1. Remove the screws on the chassis cover then put them in a safe place for later use.



2. Gently slide the cover outwards, then lift up the cover to remove it.

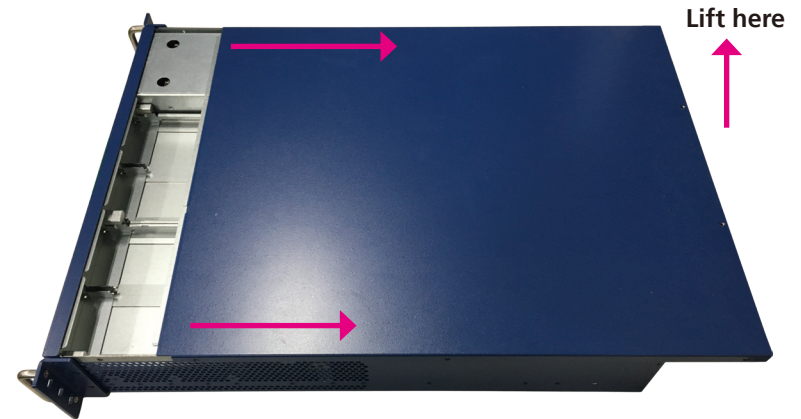

## Installing an External SATA Hard Drive

The system is equipped with 1 external SATA 3.5" HDD drive bay. To install a SATA HDD, please follow the instructions below.



Please correctly follow the below instructions and noted items to avoid making unnecessary damages.

1. Push the eject button on the HDD drive bay to release the latch.

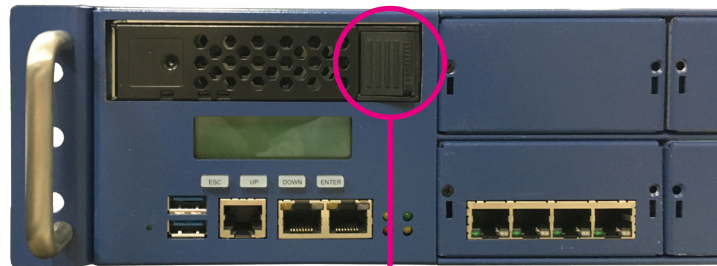

Eject button

2. Grab on the latch and pull the drive tray out gently.

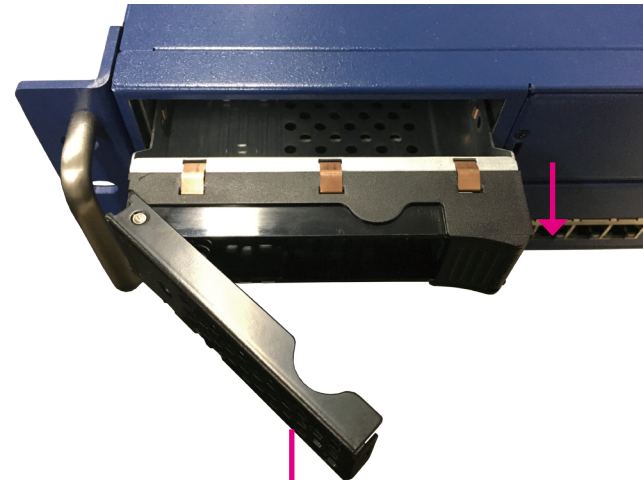

Latch

- Place the SATA drive onto the tray and align the mounting holes on the drive with the mounting holes on the tray, then use the provided mounting screws to secure the drive in place.

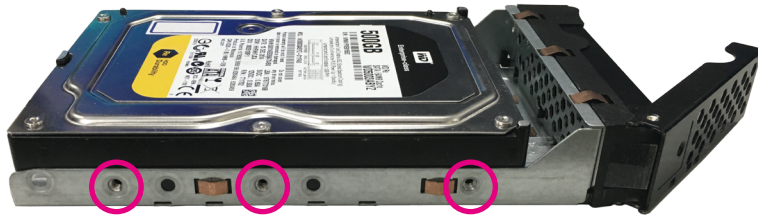

- Repeat step 3 for securing the screws on the other side of the HDD tray.

- Slide the tray back into the drive bay, and push firmly until you hear a distinctive click sound.

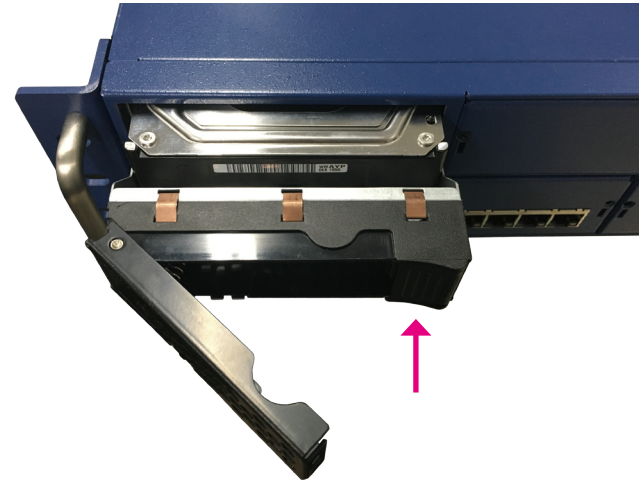

## Installing a LAN Module

The system is equipped with 8 LAN module bays. To install a LAN module, please follow the instructions below.



Please correctly follow the below instructions and noted items to avoid making unnecessary damages. Make sure the power supply is switched off and disconnected from the power sources before replacing or adding LAN modules to prevent electric shock or system damage.

1. Remove the screw on the LAN module then put them in a safe place for later use.



2. Use the handle provided, and insert the handle into the two holes on the LAN module.

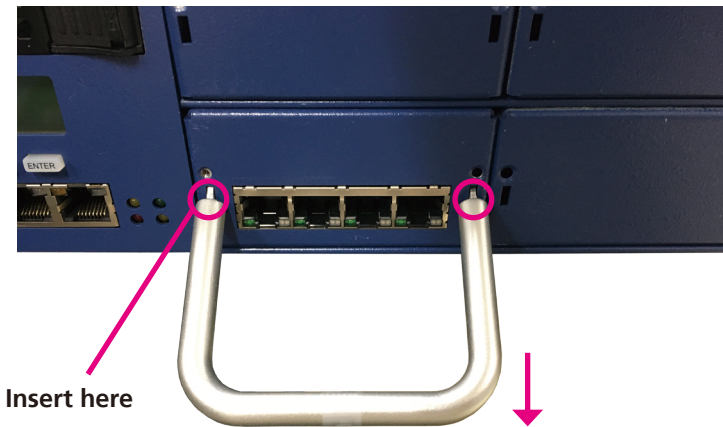

3. Once the handle is firmly secured in position, pull the handle outwards to remove the LAN module bay.

- Place the LAN module into the tray making sure the connector side of the module is at the rear side of the tray.

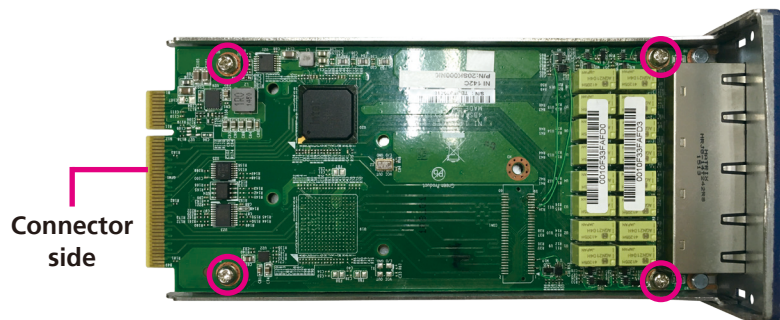

- Secure the module in place with screws, and slide the tray back into the bay.

**Important:**

Before using Optical fiber for transferring data, make sure you have connected an approved Optical Transceiver Module. User needs to install appropriate and UL approved Laser Class I Transceivers, rated 3.3Vdc, max. 1W.

## Installing the Rackmount Rails

The system comes with rack ears installed on the front panel. The rack ears are used to support the system in a rack cabinet.



Rack ear

Rack ear

1. Extend the rackmount rail to its maximum length.



Slide here



Fully extended rail

- Align the mounting holes on the rackmount rail with the mounting holes on one side of the system then secure the rackmount rail with mounting screws.



**Rackmount rail**



- Repeat steps 1 and 2 to secure the other rackmount rail to the other side.

### Rackmount Instructions

- Elevated Operating Ambient** - If installed in a closed or multi-unit rack assembly, the operating ambient temperature of the rack environment may be greater than room ambient. Therefore, consideration should be given to installing the equipment in an environment compatible with the maximum ambient temperature (T<sub>ma</sub>) specified by the manufacturer.
- Reduced Air Flow** - Installation of the equipment in a rack should be such that the amount of air flow required for safe operation of the equipment is not compromised.
- Mechanical Loading** - Mounting of the equipment in the rack should be such that a hazardous condition is not achieved due to uneven mechanical loading.
- Circuit Overloading** - Consideration should be given to the connection of the equipment to the supply circuit and the effect that overloading of the circuits might have on overcurrent protection and supply wiring. Appropriate consideration of equipment nameplate ratings should be used when addressing this concern.
- Reliable Earthing** - Reliable earthing of rack-mounted equipment should be maintained. Particular attention should be given to supply connections other than direct connections to the branch circuit (e.g. use of power strips)."



## CHAPTER 4: BIOS SETUP

This chapter describes how to use the BIOS setup program for the NSA 7136. The BIOS screens provided in this chapter are for reference only and may change if the BIOS is updated in the future.

To check for the latest updates and revisions, visit the NEXCOM website at [www.nexcom.com.tw](http://www.nexcom.com.tw).

### About BIOS Setup

The BIOS (Basic Input and Output System) Setup program is a menu driven utility that enables you to make changes to the system configuration and tailor your system to suit your individual work needs. It is a ROM-based configuration utility that displays the system's configuration status and provides you with a tool to set system parameters.

These parameters are stored in non-volatile battery-backed-up CMOS RAM that saves this information even when the power is turned off. When the system is turned back on, the system is configured with the values found in CMOS.

With easy-to-use pull down menus, you can configure such items as:

- Hard drives, diskette drives, and peripherals
- Video display type and display options
- Password protection from unauthorized use
- Power management features

The settings made in the setup program affect how the computer performs. It is important, therefore, first to try to understand all the setup options, and second, to make settings appropriate for the way you use the computer.

### When to Configure the BIOS

- This program should be executed under the following conditions:
  - When changing the system configuration
  - When a configuration error is detected by the system and you are prompted to make changes to the setup program
  - When resetting the system clock
  - When redefining the communication ports to prevent any conflicts
  - When making changes to the Power Management configuration
  - When changing the password or making other changes to the security setup

Normally, CMOS setup is needed when the system hardware is not consistent with the information contained in the CMOS RAM, whenever the CMOS RAM has lost power, or the system features need to be changed.

## Default Configuration

Most of the configuration settings are either predefined according to the Load Optimal Defaults settings which are stored in the BIOS or are automatically detected and configured without requiring any actions. There are a few settings that you may need to change depending on your system configuration.











## Entering Setup

When the system is powered on, the BIOS will enter the Power-On Self Test (POST) routines. These routines perform various diagnostic checks; if an error is encountered, the error will be reported in one of two different ways:

- If the error occurs before the display device is initialized, a series of beeps will be transmitted.
- If the error occurs after the display device is initialized, the screen will display the error message.

Powering on the computer and immediately pressing  allows you to enter Setup.

## Legends

Key	Function
	Moves the highlight left or right to select a menu.
	Moves the highlight up or down between sub-menu or fields.
	Exits the BIOS Setup Utility.
	Scrolls forward through the values or options of the highlighted field.
	Scrolls backward through the values or options of the highlighted field.
	Selects a field.
	Displays General Help.
	Load previous values.
	Load optimized default values.
	Saves and resets the system.
	Press <Enter> to enter the highlighted sub-menu

## Scroll Bar

When a scroll bar appears to the right of the setup screen, it indicates that there are more available fields not shown on the screen. Use the up and down arrow keys to scroll through all the available fields.

## Submenu

When “▶” appears on the left of a particular field, it indicates that a submenu which contains additional options are available for that field. To display the submenu, move the highlight to that field and press  .

## BIOS Setup Utility

Once you enter the AMI BIOS Setup Utility, the Main Menu will appear on the screen. The main menu allows you to select from several setup functions and one exit. Use arrow keys to select among the items and press  to accept or enter the submenu.

### Main

The Main menu is the first screen that you will see when you enter the BIOS Setup Utility.



### System Date

The date format is <day>, <month>, <date>, <year>. Day displays a day, from Monday to Sunday. Month displays the month, from January to December. Date displays the date, from 1 to 31. Year displays the year, from 1999 to 2099.

### System Time

The time format is <hour>, <minute>, <second>. The time is based on the 24-hour military-time clock. For example, 1 p.m. is 13:00:00. Hour displays hours from 00 to 23. Minute displays minutes from 00 to 59. Second displays seconds from 00 to 59.

### Access Level

Displays the access level of the current user in the BIOS.

## Advanced

The Advanced menu allows you to configure your system for basic operation. Some entries are defaults required by the system board, while others, if enabled, will improve the performance of your system or let you set some features according to your preference.



Setting incorrect field values may cause the system to malfunction.



## NCT6776 Super IO Configuration

This section is used to configure the I/O functions supported by the onboard Super I/O chip.

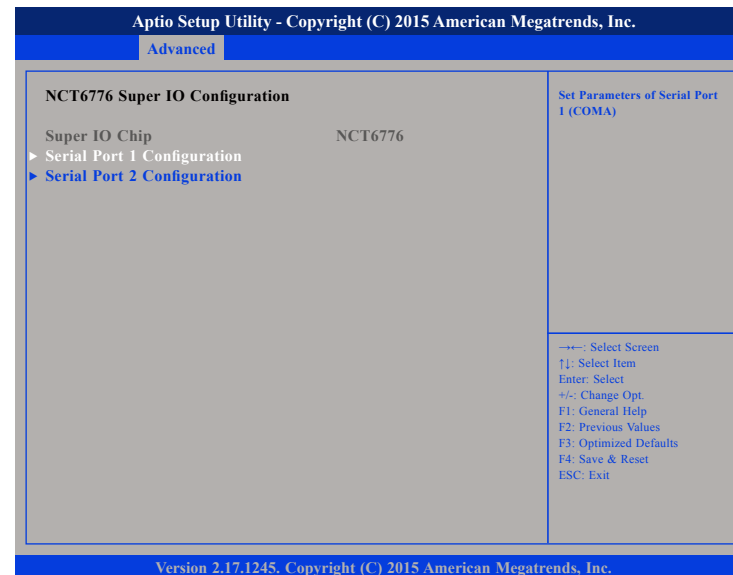

### Super IO Chip

Displays the Super I/O chip used on the board.

### Serial Port 1 Configuration

Configuration settings for serial port 1.

### Serial Port 2 Configuration

Configuration settings for serial port 2.

## Serial Port 1 Configuration

This section is used to configure serial port 1.

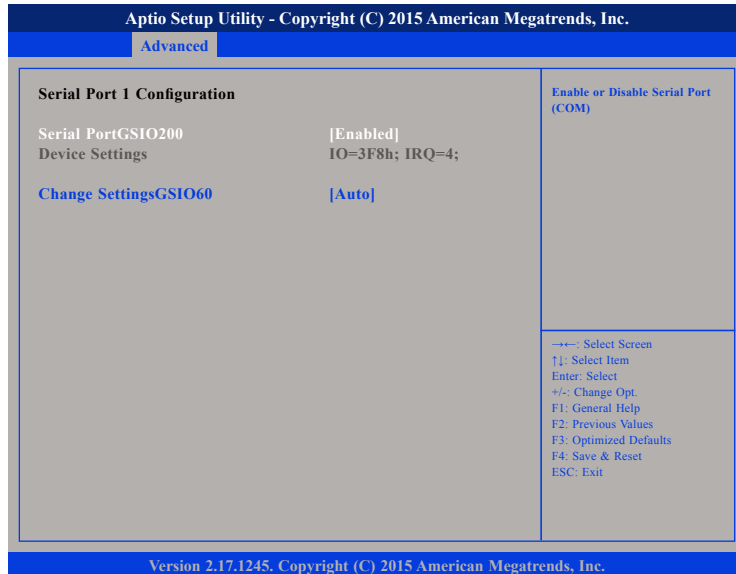

### Serial PortGSIO200

Enables or disables the serial port.

### Change SettingsGSIO60

Selects an optimal setting for the Super IO device.

## Serial Port 2 Configuration

This section is used to configure serial port 2.

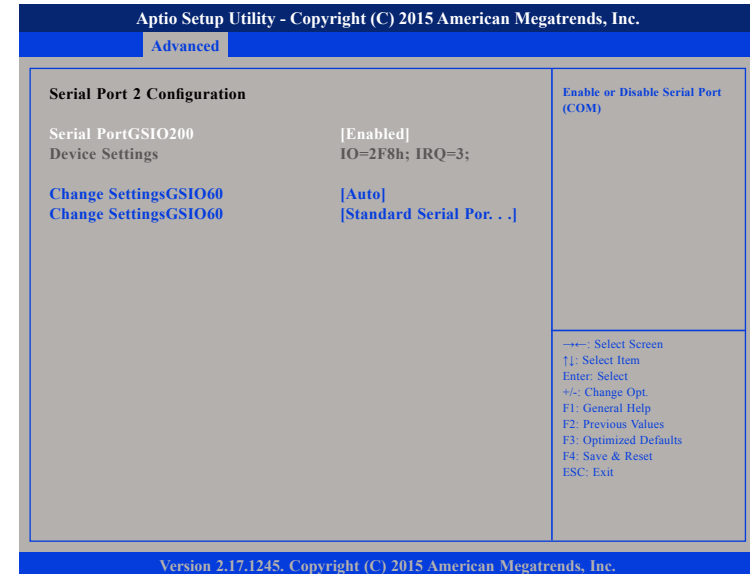

### Serial PortGSIO200

Enables or disables the serial port.

### Change SettingsGSIO60

Selects an optimal setting for the Super IO device.

## Hardware Monitor

This section is used to monitor hardware status such as temperature, fan speed and voltages.

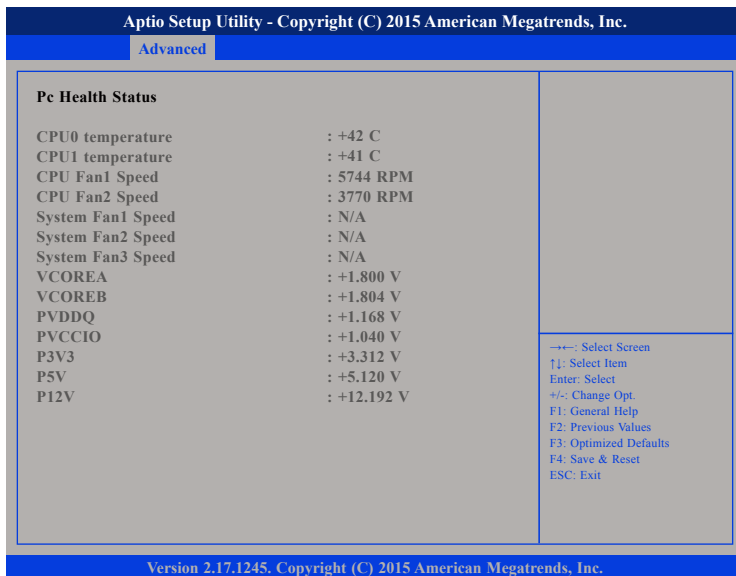

Pc Health Status	
CPU0 temperature	: +42 C
CPU1 temperature	: +41 C
CPU Fan1 Speed	: 5744 RPM
CPU Fan2 Speed	: 3770 RPM
System Fan1 Speed	: N/A
System Fan2 Speed	: N/A
System Fan3 Speed	: N/A
VCOREA	: +1.800 V
VCOREB	: +1.804 V
PVDDQ	: +1.168 V
PVCCIO	: +1.040 V
P3V3	: +3.312 V
P5V	: +5.120 V
P12V	: +12.192 V

←→: Select Screen  
 ↑↓: Select Item  
 Enter: Select  
 +/-: Change Opt.  
 F1: General Help  
 F2: Previous Values  
 F3: Optimized Defaults  
 F4: Save & Reset  
 ESC: Exit

Version 2.17.1245. Copyright (C) 2015 American Megatrends, Inc.

### CPU0 Temperature and CPU1 Temperature

Detects and displays the current CPU0 and CPU1 temperature.

### CPU Fan1 Speed to CPU Fan2 Speed

Detects and displays the current CPU Fan1 and Fan2 speed.

### System Fan1 to System Fan3 Speed

Detects and displays the current System Fan1, Fan2 and Fan3 speed.

### VCOREA to P12V

Detects and displays the output voltages.

## Serial Port Console Redirection

This section is used to configure the serial port that will be used for console redirection.



**COM0**  
 Console Redirection [Enabled]  
 ▶ Console Redirection Settings

**COM1**  
 Console Redirection [Disabled]  
 ▶ Console Redirection Settings

**Legacy Console Redirection**  
 ▶ Legacy Console Redirection Settings

**Serial Port for Out-of-Band Management / Windows Emergency Management Services (EMS)**  
 Console Redirection [Enabled]  
 ▶ Console Redirection Settings

Console Redirection Enable or Disable

←→: Select Screen  
 ↑↓: Select Item  
 Enter: Select  
 +/-: Change Opt.  
 F1: General Help  
 F2: Previous Values  
 F3: Optimized Defaults  
 F4: Save & Reset  
 ESC: Exit

Version 2.17.1245. Copyright (C) 2015 American Megatrends, Inc.

### Console Redirection

Enables or disables the console redirection.

## Console Redirection Settings

Specifies how the host computer and the remote computer (which the user is using) will exchange data. Both computers should have the same or compatible settings.



### Terminal Type

- ANSI Extended ASCII character set.
- VT100 ASCII character set.
- VT100+ Extends VT100 to support color, function keys, etc.
- VT-UTF8 Uses UTF8 encoding to map Unicode characters onto 1 or more bytes.

### Data Bits

The options are 7 and 8.

### Bits Per Second

Selects the serial port transmission speed. The speed must match the other side. Long or noisy lines may require a lower speed.

### Parity

A parity bit can be sent with the data bits to detect some transmission errors.

- Even Parity bit is 0 if the number of 1's in the data bits is even.
- Odd Parity bit is 0 if number of 1's in the data bits is odd.

### Stop Bits

Stop bits indicate the end of a serial data packet. (A start bit indicates the beginning). The standard setting is 1 stop bit. Communication with slow devices may require more than 1 stop bit.

### Flow Control

Flow control can prevent data loss from buffer overflow. When sending data and the receiving buffers are full, a "stop" signal can be sent to stop the data flow.

### VT-UTF8 Combo Key Support

Enables or disables VT-UTF8 combination key support for ANSI/VT100 terminals.

### Recorder Mode

When this field is enabled, only text will be sent. This is to capture the terminal data.

### Resolution 100x31

Enables or disables extended terminal resolution.

### Legacy OS Redirection

Selects the number of rows and columns that support redirection.

### Putty Keypad

Selects the Putty keyboard emulation type.

### Redirection After BIOS

The settings specify if BootLoader is selected, then Legacy console redirection is disabled before booting to Legacy OS. Default value is Always Enable which means Legacy Console Redirection is enabled for Legacy OS.



## PCI Subsystem Settings

This section is used to configure the PCI.



### Above 4G Decoding

Enables or disables decoding of 64bit devices in 4G address space.

### SR-IOV Support

Enables or disables SR-IOV support.

## PCI Express Settings

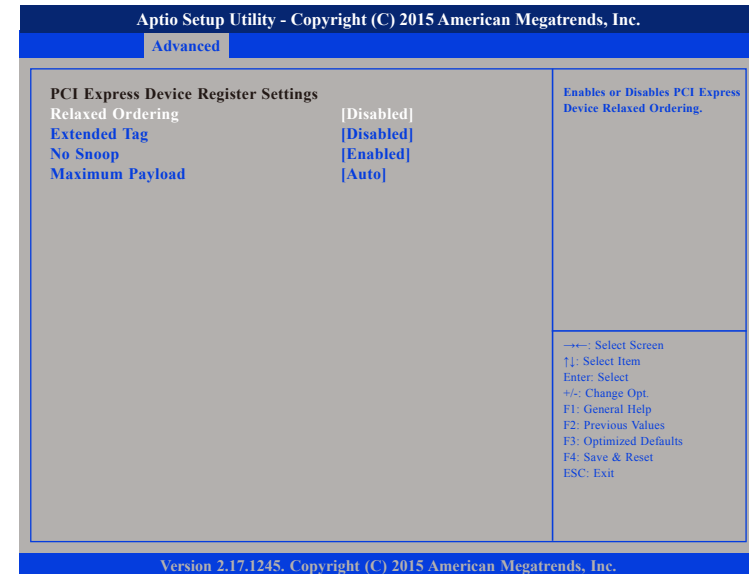

### Relaxed Ordering

Enables or disables the PCI Express device's relaxed ordering.

### Extended Tag

When this function is enabled, it allows a device to use 8-bit tag field as a request.

### No Snoop

Enables or disables the PCI Express device's no snoop option.

### Maximum Payload

Selects the maximum TLP payload size of the PCI Express devices.

## Network Stack

This section is used to configure the network stack.



## Network Stack

Enables or disables UEFI network stack.

## CSM Configuration

This section is used to configure the compatibility support module features.

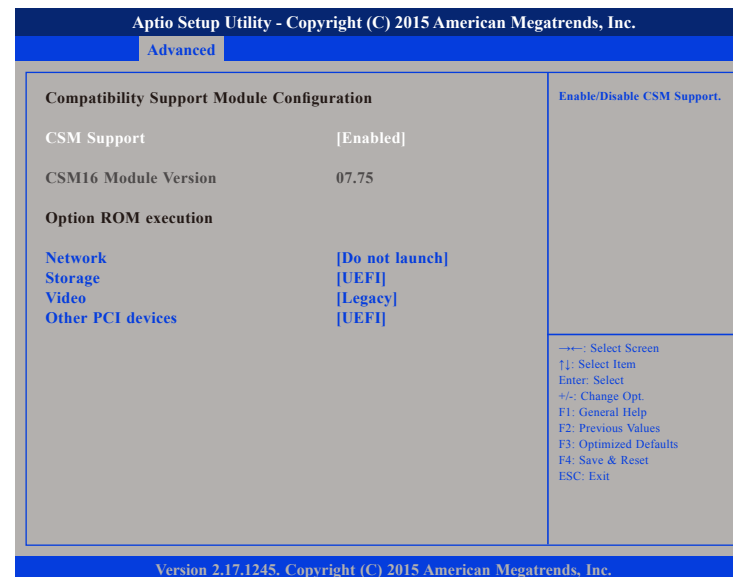

## CSM Support

This field is used to enable or disable CSM support, if Auto option is selected, based on OS, CSM will be enabled or disabled automatically.

## Network

Enables or disables the boot option for legacy network devices.

## Storage

Enables or disables the boot option for legacy storage devices.

## Video

Enables or disables the boot option for legacy video devices.

## Other PCI Devices

Enables or disables the boot option for legacy PCI devices.

## Trusted Computing

This section is used to configure trusted computing settings.

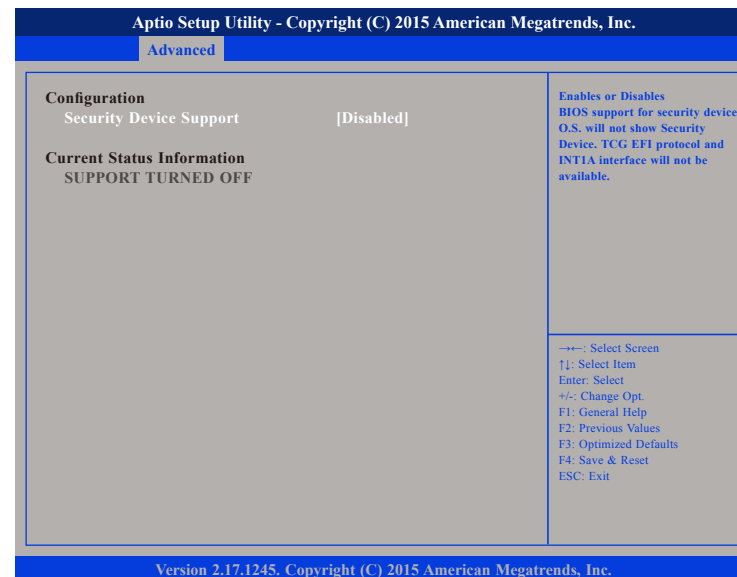

## Security Device Support

Enables or disables BIOS support for security device. O.S. will not show security device. TCG EFI protocol and INT1A interface will not be available.

## USB Configuration

This section is used to configure the USB.



### Legacy USB Support

Enable Enables Legacy USB.

Auto Disables support for Legacy when no USB devices are connected.

Disable Keeps USB devices available only for EFI applications.

### XHCI Hand-off

This is a workaround for OSs that does not support XHCI hand-off. The XHCI ownership change should be claimed by the XHCI driver.

### EHCI Hand-Off

This is a workaround for OSs that does not support EHCI hand-off. The EHCI ownership change should be claimed by the EHCI driver.

### USB Mass Storage Driver

Enables or disables USB mass storage device driver support.

### Port 60/64 Emulation

Enables the 60h/64h I/O port emulation. You must enable this to fully support USB keyboard legacy for non-USB OSes.

### USB Transfer Time-out

The time-out value for control, bulk, and Interrupt transfers.

### Device Reset Time-out

Selects the USB mass storage device's start unit command timeout.

### Device Power-up Delay

Maximum time the value will take before it properly reports it self to the Host Controller. "Auto" uses default value: for a Root port it is 100 ms, for a Hub port the delay is taken from Hub descriptor.

## Intel RC Setup

This section is used to configure the processor and chipset settings.

## Processor Configuration

### Hyper-Threading [ALL]

Enables or disables hyper-threading technology.

### Execute Disable Bit

When set to Disabled, it will force the XD feature flag to always return to 0.

### Enable Intel® TXT Support

Enables or disables Intel TXT support.

### VMX

Enables or disables Virtual Machine Extensions.

### Enable SMX

Enables or disables Secure Mode Extensions.

### Hardware Prefetcher

Enables or disables the MLC streamer prefetcher.

## Processor Configuration



### CPU Socket 0 Configuration

Processor settings for the CPU on socket 0.

### CPU Socket 1 Configuration

Processor settings for the CPU on socket 1.

## CPU Socket 0 Configuration

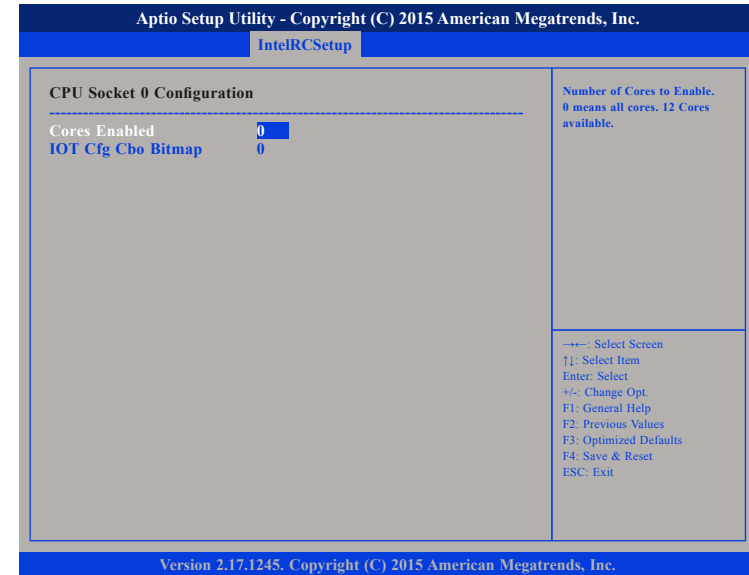

### Cores Enabled

Configures the number of cores to enable. 0 means all cores.

### IOT Cfg Cbo Bitmap

Configures the bit to enable IOT/OCLA.

## CPU Socket 1 Configuration

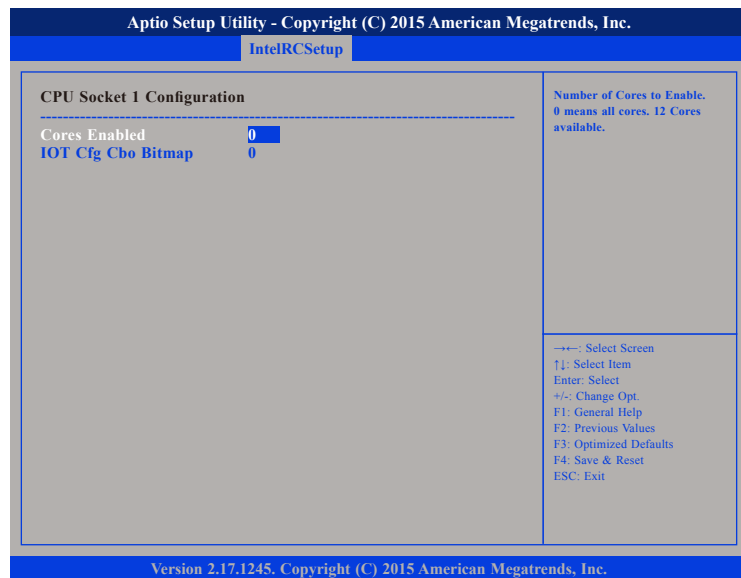

### Cores Enabled

Configures the number of cores to enable. 0 means all cores.

### IOT Cfg Cbo Bitmap

Configures the bit to enable IOT/OCLA.

## QPI Configuration



## QPI General Configuration

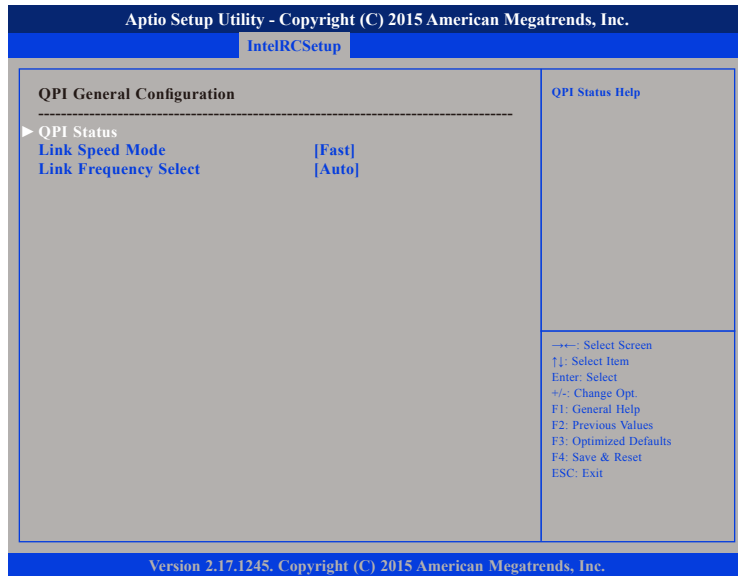

### Link Speed Mode

Configures the link speed mode.

### Link Frequency Select

Configures the QPI frequency.

## QPI Status

Displays information on the current QPI configuration.

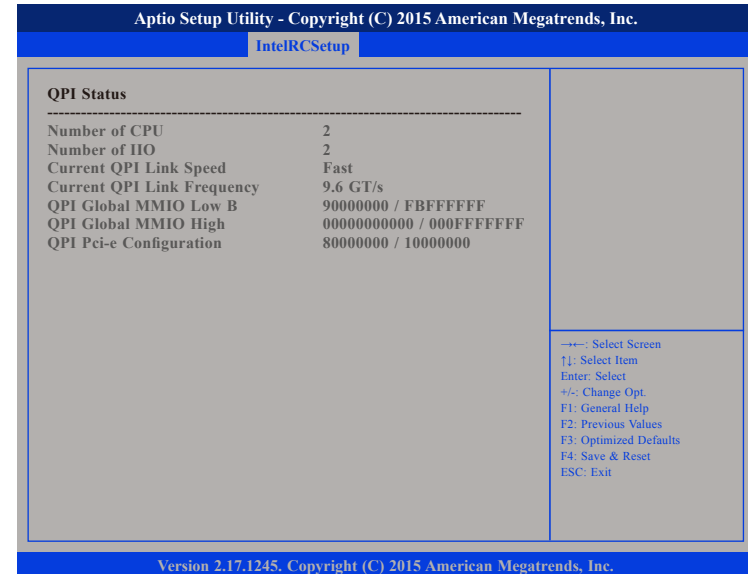



## Memory Configuration

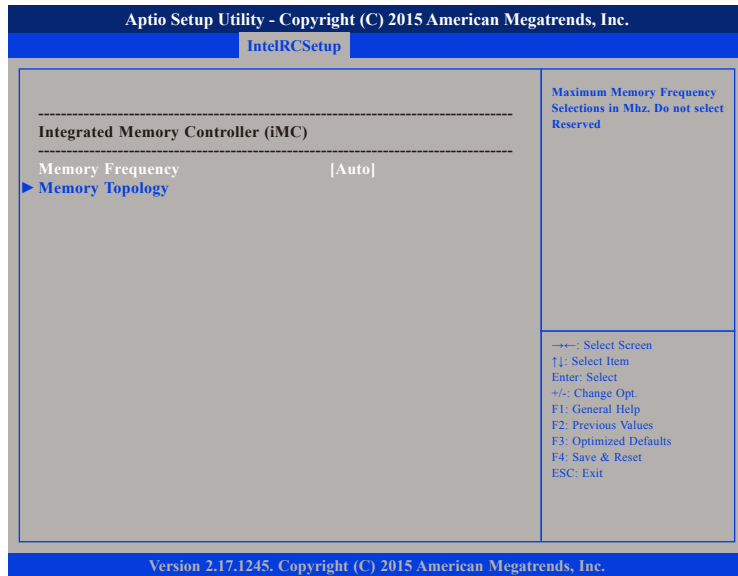

### Memory Frequency

Configures the maximum frequency of the memory. Do not select Reserved.

## Memory Topology

Detects and displays the information on the memory installed.

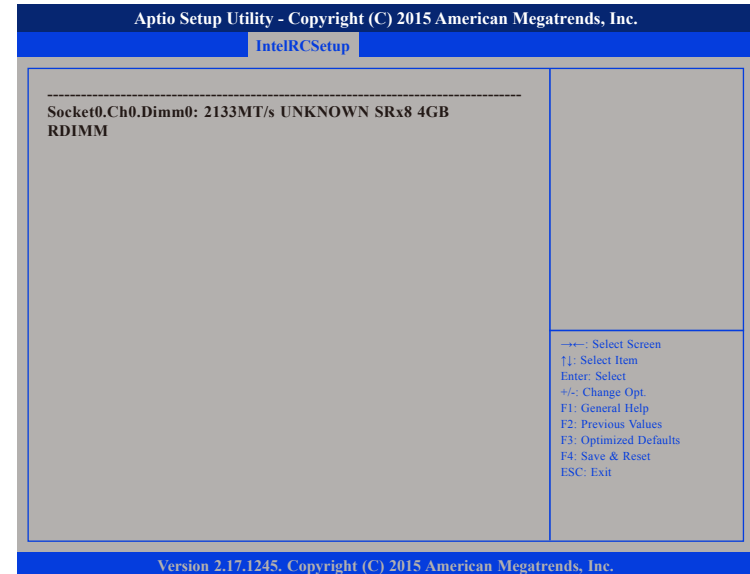

## I/O Configuration

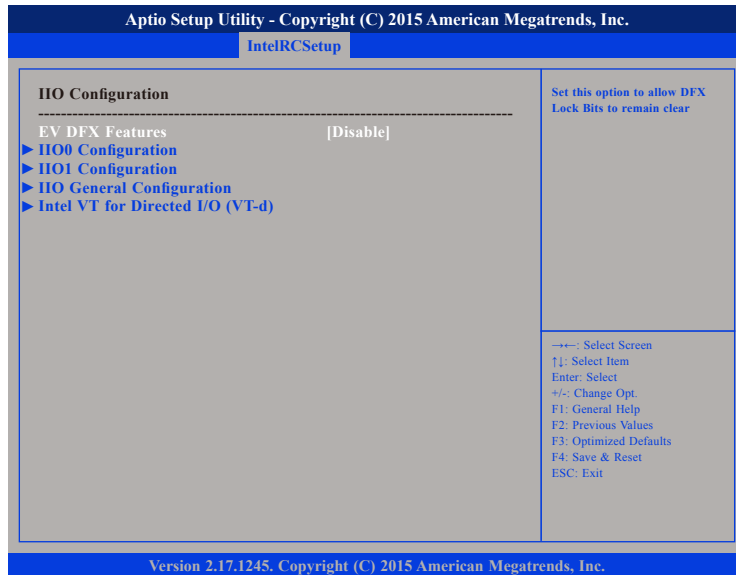

### EV DFX Features

Enables or disables the DFX Lock Bits to remain clear.

## IIO0 Configuration

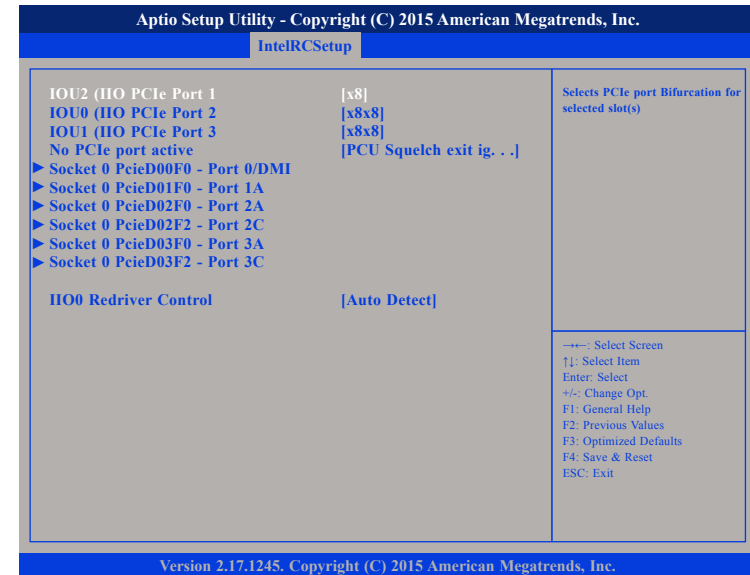

### IOU2 (IIO PCIe Port 1)

Port Bifurcation settings for IOU 2.

### IOU0 (IIO PCIe Port 2)

Port Bifurcation settings for IOU 0.

### IOU1 (IIO PCIe Port 3)

Port Bifurcation settings for IOU 1.

### No PCIe Port Active

Configures the workaround solution for ECO when the PCIe ports are not active.

### IIO0 Redriver Control

Configures the redriver options for IIO0.

## IIO1 Configuration

Aptio Setup Utility - Copyright (C) 2015 American Megatrends, Inc.		
IntelRCSetup		
IOU2 (IIO PCIe Port 1)	[x8]	Selects PCIe port Bifurcation for selected slot(s)
IOU0 (IIO PCIe Port 2)	[x8x8]	
IOU1 (IIO PCIe Port 3)	[x8x8]	
No PCIe port active	[PCU Squeleh exit ig. . .]	
▶ Socket 1 PCIe D00F0 - Port 0/DMI		
▶ Socket 1 PCIe D01F0 - Port 1A		
▶ Socket 1 PCIe D02F0 - Port 2A		
▶ Socket 1 PCIe D02F2 - Port 2C		
▶ Socket 1 PCIe D03F0 - Port 3A		
▶ Socket 1 PCIe D03F2 - Port 3C		
IIO1 Redriver Control	[Auto Detect]	
		→←: Select Screen ↑↓: Select Item Enter: Select +/-: Change Opt. F1: General Help F2: Previous Values F3: Optimized Defaults F4: Save & Reset ESC: Exit
Version 2.17.1245, Copyright (C) 2015 American Megatrends, Inc.		

### IOU2 (IIO PCIe Port 1)

Port Bifurcation settings for IOU 2.

### IOU0 (IIO PCIe Port 2)

Port Bifurcation settings for IOU 0.

### IOU1 (IIO PCIe Port 3)

Port Bifurcation settings for IOU 1.

### No PCIe Port Active

Configures the workaround solution for ECO when the PCIe ports are not active.

### IIO1 Redriver Control

Configures the redriver options for IIO1.

## IIO General Configuration

Aptio Setup Utility - Copyright (C) 2015 American Megatrends, Inc.		
IntelRCSetup		
TXT DPR memory setting	[3M DPR]	Allows selection of the TXT DPR size in system
IIO 0		
IIO IOAPIC	[Enable]	
IIO 1		
IIO IOAPIC	[Enable]	
		→←: Select Screen ↑↓: Select Item Enter: Select +/-: Change Opt. F1: General Help F2: Previous Values F3: Optimized Defaults F4: Save & Reset ESC: Exit
Version 2.17.1245, Copyright (C) 2015 American Megatrends, Inc.		

### TXT DPR Memory Setting

Configures the TXT DPR size.

### IIO IOAPIC (IIO 0 and IIO 1)

Enables or disables I/O Advanced Power Interface Configuration (IIOAPIC) for IIO 0 or IIO 1.

## Intel VT for Directed I/O (VT-d)



### Intel VT for Directed I/O

Enables or disables Intel® Virtualization Technology for Directed I/O (VT-d) by reporting the I/O device assignment to VMM through DMAR ACPI tables.

## PCH Configuration



## PCH Devices



### SMBUS Device

Enables or disables SMBUS device.

### PCH Display

Enables or disables the PCH Display.

### PCH State After G3

Configures the PCH state after G3.

## PCI Express Configuration

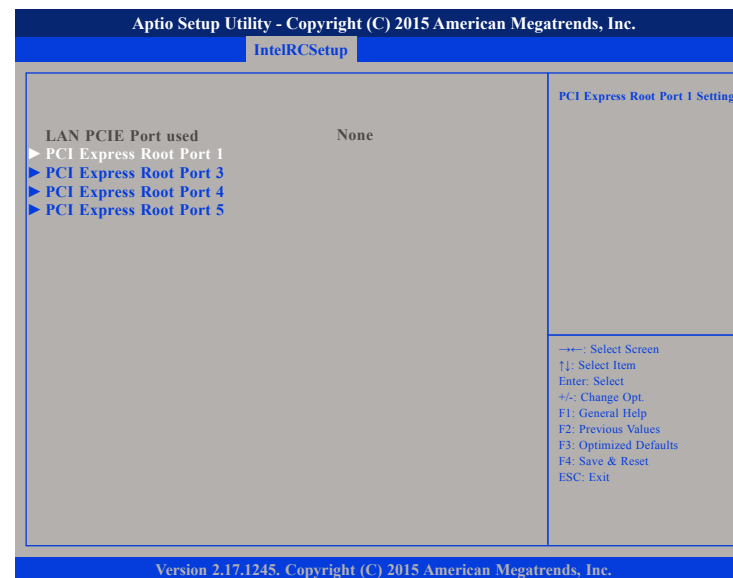

### PCI Express Root Port 1, 3, 4 and 5

Settings for PCI Express Root Port 1, 3, 4 and 5.

## PCH SATA Configuration

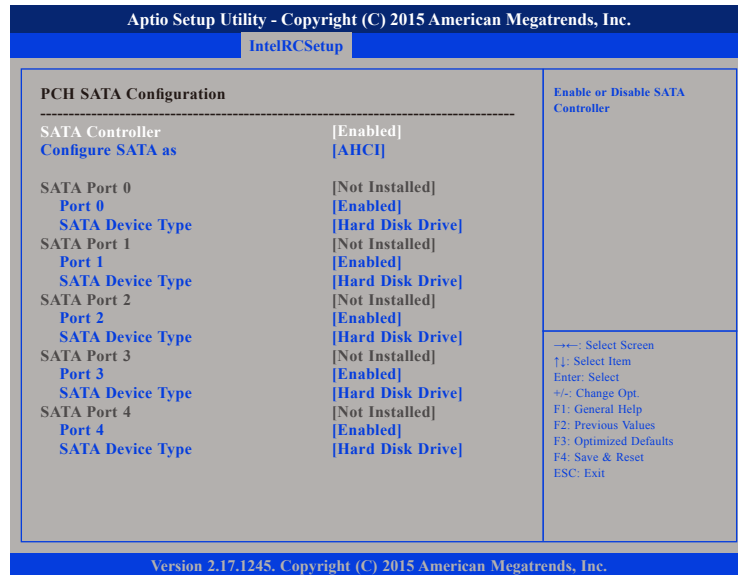

### Port 0 to Port 4

Enables or disables Serial ATA port 0 to port 4.

### SATA Device Type

Identifies what type of SATA device is connected.

### SATA Controller

Enables or disables the SATA controller.

### Configure SATA as

Configures the SATA as IDE or AHCI.

**IDE** This option configures the Serial ATA drives as Parallel ATA physical storage device.

**AHCI** This option configures the Serial ATA drives to use AHCI (Advanced Host Controller Interface). AHCI allows the storage driver to enable the advanced Serial ATA features which will increase storage performance.

## USB Configuration



### xHCI Mode

Configures the XHCI mode.

### Trunk Clock Gating

Enables or disables Trunk Clock Gating.

### USB Ports Per-Port

Enables or disables control of each USB port.

## Network Configuration



### ByPass Auto Detect

Enables or disables automatic LAN Bypass function.

## Security

This section is used to configure the processor and chipset settings.

Aptio Setup Utility - Copyright (C) 2015 American Megatrends, Inc.						
Main	Advanced	IntelRCSetup	Security	Boot	Save & Exit	
<p><b>Password Description</b></p> <p>If ONLY the Administrator's password is set, then this only limits access to Setup and is only asked for when entering Setup.</p> <p>If ONLY the User's password is set, then this is a power on password and must be entered to boot or enter Setup. In Setup the User Will have Administrator rights.</p> <p>The password length must be in the following range:</p> <table> <tr> <td>Minimum length</td> <td>3</td> </tr> <tr> <td>Maximum length</td> <td>20</td> </tr> </table> <p>Administrator Password</p>		Minimum length	3	Maximum length	20	<p>Set Administrator Password</p>
Minimum length	3					
Maximum length	20					
		<p>←→: Select Screen ↑↓: Select Item Enter: Select +/-: Change Opt. F1: General Help F2: Previous Values F3: Optimized Defaults F4: Save &amp; Reset ESC: Exit</p>				
Version 2.17.1245. Copyright (C) 2015 American Megatrends, Inc.						

### Administrator Password

Select this to reconfigure the administrator's password.

## Boot

This section is used to configure the boot features.

Aptio Setup Utility - Copyright (C) 2015 American Megatrends, Inc.					
Main	Advanced	IntelRCSetup	Security	Boot	Save & Exit
<p><b>Boot Configuration</b></p> <p>Setup Prompt Timeout [1]</p> <p>Bootup NumLock State [On]</p> <p>Quiet Boot [Disabled]</p> <p>Boot mode select [LEGACY]</p> <p><b>FIXED BOOT ORDER Priorities</b></p> <p>Boot Option #1 [USB CD/DVD]</p> <p>Boot Option #2 [USB Key:JetFlashTra...]</p> <p>Boot Option #3 [Hard Disk]</p> <p>Boot Option #4 [USB Hard Disk]</p> <p>Boot Option #5 [CD/DVD]</p> <p>Boot Option #6 [USB Floppy]</p> <p>Boot Option #7 [USB Lan]</p> <p>Boot Option #8 [Network]</p> <p>▶ USB Key Drive BBS Priorities</p>		<p>Number of seconds to wait for setup activation key. 65535(0xFFFF) means indefinite waiting.</p>			
		<p>←→: Select Screen ↑↓: Select Item Enter: Select +/-: Change Opt. F1: General Help F2: Previous Values F3: Optimized Defaults F4: Save &amp; Reset ESC: Exit</p>			
Version 2.17.1245. Copyright (C) 2015 American Megatrends, Inc.					

### Setup Prompt Timeout

Selects the number of seconds to wait for the setup activation key. 65535(0xFFFF) denotes indefinite waiting.

### Bootup NumLock State

This allows you to determine the default state of the numeric keypad. By default, the system boots up with NumLock on wherein the function of the numeric keypad is the number keys. When set to Off, the function of the numeric keypad is the arrow keys.



### Quiet Boot

Enabled Displays OEM logo instead of the POST messages.  
 Disabled Displays normal POST messages.

### Boot Mode Select

Configures the boot mode option.

### USB Key Drive BBS Priorities

Adjust the boot sequence for USB devices. Boot Option #1 is the first boot device that the system will boot from, next will be Boot Option #2 and so forth.

## Save & Exit



### Save Changes and Exit

To save the changes and exit the Setup utility, select this field then press <Enter>. A dialog box will appear. Confirm by selecting Yes. You can also press <F4> to save and exit Setup.

### Discard Changes and Exit

To exit the Setup utility without saving the changes, select this field then press <Enter>. You may be prompted to confirm again before exiting. You can also press <ESC> to exit without saving the changes.



---

### **Save Changes and Reset**

To save the changes and reset, select this field then press <Enter>. A dialog box will appear. Confirm by selecting Yes.

### **Discard Changes and Reset**

To exit the Setup utility without saving the changes, select this field then press <Enter>. You may be prompted to confirm again before exiting.

### **Restore Defaults**

To restore the BIOS to default settings, select this field then press <Enter>. A dialog box will appear. Confirm by selecting Yes.

### **Boot Override**

To bypass the boot sequence from the Boot Option List and boot from a particular device, select the desired device and press <Enter>.