



NEXCOM International Co., Ltd.

Industrial Computing Solutions

Fan-less Computer

NISE 3640E Series

User Manual

Contents

Preface

Copyright	iv
Disclaimer	iv
Acknowledgements	iv
Regulatory Compliance Statements	iv
Declaration of Conformity	iv
RoHS Compliance	v
Warranty and RMA	vi
Safety Information	viii
Installation Recommendations	viii
Safety Precautions	ix
Technical Support and Assistance	x
Conventions Used in this Manual	x
Global Service Contact Information	xi
Package Contents	xiii
Ordering Information	xiv

Chapter 1: Product Introduction

Overview	1
Key Features	1
Hardware Specifications	2
Knowing Your NISE 3640E	4
Front Panel	4
Rear Panel	5
Mechanical Dimensions	6

Chapter 2: Jumpers and Connectors

Before You Begin	7
Precautions	7
Jumper Settings	8
Locations of the Jumpers and Connectors for NISE 3640	9
NISE 3640	9
Jumpers	10
ME Pin Header	10
COM4 RS232 RI# Pin Power Select	10
LVDS Power Pin Header	11
Connector Pin Definitions	12
External I/O Interfaces - Front Panel	12
USB 3.0	12
USB 2.0	12
DisplayPort A	13
DisplayPort B	13
CFast	14
SIM Card Connector	14
Power Switch	15
External I/O Interfaces - Rear Panel	16
Remote Power on/off Switch	16
DC-in Power Jack	16
COM 1 and COM 2 Ports	17
COM3 to COM6	18
LAN1 and LAN2 Ports	19

LAN3 and LAN4 Ports.....	20
VGA and DVI-D Connectors	21
Audio Connectors.....	22
Internal Connectors.....	23
SIM Card Line-out Pin Header	23
SIM Card Mic-in Pin Header	23
DC-in Power Connector	24
CMOS Pin Header	24
Reset JST Connector.....	25
LVDS Channel A Connector.....	25
LVDS Channel B Connector	26
LVDS Backlight Connector.....	26
Line-in 1 Pin Header	27
Line-in 2 Pin Header.....	27
SATA3 Connector 1.....	28
SATA3 Connector 2.....	28
SATA3 Power Connector 1	29
SATA3 Power Connector 2	29
GPS JST Connector.....	30
USB 2.0 JST Connector.....	30
PCIe x8 Slot.....	31
Mini-PCIe Connector.....	32
GPIO Pin Header	33
GPIO LED Pin Header.....	33
Smart Fan1 Connector	34
Smart Fan2 Connector	34
External LED Pin Header	35
Power/PSION Header.....	35
80 Port.....	36
External SMBus	36
Flash BIOS CON.....	37
Mini-PCIe Slot	38

Chapter 3: System Setup

Mount the System to the Wall	39
Removing the Chassis Bottom Cover	40
Installing a SATA Hard Drive	41
Installing a SATA DOM	44
Installing a PCIe/PCI Expansion Card.....	46
Removing the Chassis Top Cover.....	48
Installing a SO DIMM	49
Installing a Wireless LAN Module (half-size).....	50
Installing a Wireless LAN Module (full-size).....	51
Installing a GPS Module	52
Installing Antennas	54
Installing a SIM Card	55
Installing a CompactFlash Card	56

Chapter 4: BIOS Setup

About BIOS Setup	57
When to Configure the BIOS.....	57
Default Configuration	58
Entering Setup	58
Legends	58
BIOS Setup Utility.....	60
Main	60
Advanced	61
Chipset.....	72
Boot.....	84
Security	86
Save & Exit	86

Appendix A: Power Consumption.....87

Appendix B: GPI/O Programming Guide.....89

Appendix C: Watchdog Timer Setting.....91

Preface

Copyright

This publication, including all photographs, illustrations and software, is protected under international copyright laws, with all rights reserved. No part of this manual may be reproduced, copied, translated or transmitted in any form or by any means without the prior written consent from NEXCOM International Co., Ltd.

Disclaimer

The information in this document is subject to change without prior notice and does not represent commitment from NEXCOM International Co., Ltd. However, users may update their knowledge of any product in use by constantly checking its manual posted on our website: <http://www.nexcom.com>. NEXCOM shall not be liable for direct, indirect, special, incidental, or consequential damages arising out of the use of any product, nor for any infringements upon the rights of third parties, which may result from such use. Any implied warranties of merchantability or fitness for any particular purpose is also disclaimed.

Acknowledgements

NISE 3640E Series is a trademark of NEXCOM International Co., Ltd. All other product names mentioned herein are registered trademarks of their respective owners.

Regulatory Compliance Statements

This section provides the FCC compliance statement for Class B devices and describes how to keep the system CE compliant.

Declaration of Conformity

FCC

This equipment has been tested and verified to comply with the limits for a Class B digital device, pursuant to Part 15 of FCC Rules. These limits are designed to provide reasonable protection against harmful interference when the equipment is operated in a commercial environment. This equipment generates, uses, and can radiate radio frequency energy and, if not installed and used in accordance with the instructions, may cause harmful interference to radio communications. Operation of this equipment in a residential area (domestic environment) is likely to cause harmful interference, in which case the user will be required to correct the interference (take adequate measures) at their own expense.

CE

The product(s) described in this manual complies with all applicable European Union (CE) directives if it has a CE marking. For computer systems to remain CE compliant, only CE-compliant parts may be used. Maintaining CE compliance also requires proper cable and cabling techniques.

RoHS Compliance



NEXCOM RoHS Environmental Policy and Status Update

This publication, including all photographs, illustrations and software, is protected under international copyright laws, with all rights reserved. No part of this manual may be reproduced, copied, translated or transmitted in any form or by any means without the prior written consent from NEXCOM International Co., Ltd.

RoHS restricts the use of Lead (Pb) < 0.1% or 1,000ppm, Mercury (Hg) < 0.1% or 1,000ppm, Cadmium (Cd) < 0.01% or 100ppm, Hexavalent Chromium (Cr6+) < 0.1% or 1,000ppm, Polybrominated biphenyls (PBB) < 0.1% or 1,000ppm, and Polybrominated diphenyl Ethers (PBDE) < 0.1% or 1,000ppm.

In order to meet the RoHS compliant directives, NEXCOM has established an engineering and manufacturing task force to implement the introduction of green products. The task force will ensure that we follow the standard NEXCOM development procedure and that all the new RoHS components and new manufacturing processes maintain the highest industry quality levels for which NEXCOM are renowned.

The model selection criteria will be based on market demand. Vendors and suppliers will ensure that all designed components will be RoHS compliant.

How to recognize NEXCOM RoHS Products?

For existing products where there are non-RoHS and RoHS versions, the suffix "(LF)" will be added to the compliant product name.

All new product models launched after January 2006 will be RoHS compliant. They will use the usual NEXCOM naming convention.

Warranty and RMA

NEXCOM Warranty Period

NEXCOM manufactures products that are new or equivalent to new in accordance with industry standard. NEXCOM warrants that products will be free from defect in material and workmanship for 2 years, beginning on the date of invoice by NEXCOM. HCP series products (Blade Server) which are manufactured by NEXCOM are covered by a three year warranty period.

NEXCOM Return Merchandise Authorization (RMA)

- Customers shall enclose the “NEXCOM RMA Service Form” with the returned packages.
- Customers must collect all the information about the problems encountered and note anything abnormal or, print out any on-screen messages, and describe the problems on the “NEXCOM RMA Service Form” for the RMA number apply process.
- Customers can send back the faulty products with or without accessories (manuals, cable, etc.) and any components from the card, such as CPU and RAM. If the components were suspected as part of the problems, please note clearly which components are included. Otherwise, NEXCOM is not responsible for the devices/parts.
- Customers are responsible for the safe packaging of defective products, making sure it is durable enough to be resistant against further damage and deterioration during transportation. In case of damages occurred during transportation, the repair is treated as “Out of Warranty.”
- Any products returned by NEXCOM to other locations besides the customers’ site will bear an extra charge and will be billed to the customer.

Repair Service Charges for Out-of-Warranty Products

NEXCOM will charge for out-of-warranty products in two categories, one is basic diagnostic fee and another is component (product) fee.

Repair Service Charges for Out-of-Warranty Products

NEXCOM will charge for out-of-warranty products in two categories, one is basic diagnostic fee and another is component (product) fee.

System Level

- Component fee: NEXCOM will only charge for main components such as SMD chip, BGA chip, etc. Passive components will be repaired for free, ex: resistor, capacitor.
- Items will be replaced with NEXCOM products if the original one cannot be repaired. Ex: motherboard, power supply, etc.
- Replace with 3rd party products if needed.
- If RMA goods can not be repaired, NEXCOM will return it to the customer without any charge.

Board Level

- Component fee: NEXCOM will only charge for main components, such as SMD chip, BGA chip, etc. Passive components will be repaired for free, ex: resistors, capacitors.
- If RMA goods can not be repaired, NEXCOM will return it to the customer without any charge.

Warnings

Read and adhere to all warnings, cautions, and notices in this guide and the documentation supplied with the chassis, power supply, and accessory modules. If the instructions for the chassis and power supply are inconsistent with these instructions or the instructions for accessory modules, contact the supplier to find out how you can ensure that your computer meets safety and regulatory requirements.

Cautions

Electrostatic discharge (ESD) can damage system components. Do the described procedures only at an ESD workstation. If no such station is available, you can provide some ESD protection by wearing an antistatic wrist strap and attaching it to a metal part of the computer chassis.

Safety Information

Before installing and using the device, note the following precautions:

- Read all instructions carefully.
- Do not place the unit on an unstable surface, cart, or stand.
- Follow all warnings and cautions in this manual.
- When replacing parts, ensure that your service technician uses parts specified by the manufacturer.
- Avoid using the system near water, in direct sunlight, or near a heating device.
- The load of the system unit does not solely rely for support from the rackmounts located on the sides. Firm support from the bottom is highly necessary in order to provide balance stability.
- The computer is provided with a battery-powered real-time clock circuit. There is a danger of explosion if battery is incorrectly replaced. Replace only with the same or equivalent type recommended by the manufacturer. Discard used batteries according to the manufacturer's instructions.



Danger of explosion if battery is incorrectly replaced. Replace with the same or equivalent type recommended by the manufacturer. Discard used batteries according to the manufacturer's instructions.

Installation Recommendations

Ensure you have a stable, clean working environment. Dust and dirt can get into components and cause a malfunction. Use containers to keep small components separated.

Adequate lighting and proper tools can prevent you from accidentally damaging the internal components. Most of the procedures that follow require only a few simple tools, including the following:

- A Philips screwdriver
- A flat-tipped screwdriver
- A grounding strap
- An anti-static pad

Using your fingers can disconnect most of the connections. It is recommended that you do not use needle-nose pliers to disconnect connections as these can damage the soft metal or plastic parts of the connectors.

Safety Precautions

1. Read these safety instructions carefully.
2. Keep this User Manual for later reference.
3. Disconnect this equipment from any AC outlet before cleaning. Use a damp cloth. Do not use liquid or spray detergents for cleaning.
4. For plug-in equipment, the power outlet socket must be located near the equipment and must be easily accessible.
5. Keep this equipment away from humidity.
6. Put this equipment on a stable surface during installation. Dropping it or letting it fall may cause damage.
7. The openings on the enclosure are for air convection to protect the equipment from overheating. **DO NOT COVER THE OPENINGS.**
8. Make sure the voltage of the power source is correct before connecting the equipment to the power outlet.
9. Place the power cord in a way so that people will not step on it. Do not place anything on top of the power cord. Use a power cord that has been approved for use with the product and that it matches the voltage and current marked on the product's electrical range label. The voltage and current rating of the cord must be greater than the voltage and current rating marked on the product.
10. All cautions and warnings on the equipment should be noted.
11. If the equipment is not used for a long time, disconnect it from the power source to avoid damage by transient overvoltage.
12. Never pour any liquid into an opening. This may cause fire or electrical shock.
13. Never open the equipment. For safety reasons, the equipment should be opened only by qualified service personnel.
14. If one of the following situations arises, get the equipment checked by service personnel:
 - a. The power cord or plug is damaged.
 - b. Liquid has penetrated into the equipment.
 - c. The equipment has been exposed to moisture.
 - d. The equipment does not work well, or you cannot get it to work according to the user's manual.
 - e. The equipment has been dropped and damaged.
 - f. The equipment has obvious signs of breakage.
15. Do not place heavy objects on the equipment.
16. The unit uses a three-wire ground cable which is equipped with a third pin to ground the unit and prevent electric shock. Do not defeat the purpose of this pin. If your outlet does not support this kind of plug, contact your electrician to replace your obsolete outlet.
17. **CAUTION: DANGER OF EXPLOSION IF BATTERY IS INCORRECTLY REPLACED. REPLACE ONLY WITH THE SAME OR EQUIVALENT TYPE RECOMMENDED BY THE MANUFACTURER. DISCARD USED BATTERIES ACCORDING TO THE MANUFACTURER'S INSTRUCTIONS.**

Technical Support and Assistance

1. For the most updated information of NEXCOM products, visit NEXCOM's website at www.nexcom.com.
2. For technical issues that require contacting our technical support team or sales representative, please have the following information ready before calling:
 - Product name and serial number
 - Detailed information of the peripheral devices
 - Detailed information of the installed software (operating system, version, application software, etc.)
 - A complete description of the problem
 - The exact wordings of the error messages

Warning!

1. Handling the unit: carry the unit with both hands and handle it with care.
2. Maintenance: to keep the unit clean, use only approved cleaning products or clean with a dry cloth.
3. CompactFlash: Turn off the unit's power before inserting or removing a CompactFlash storage card.

Conventions Used in this Manual



Warning:

Information about certain situations, which if not observed, can cause personal injury. This will prevent injury to yourself when performing a task.



Caution:

Information to avoid damaging components or losing data.



Note:

Provides additional information to complete a task easily.



Safety Warning: This equipment is intended for installation in a Restricted Access Location only.

Global Service Contact Information

Headquarters

NEXCOM International Co., Ltd.

15F, No. 920, Chung-Cheng Rd., ZhongHe District, New Taipei City, 23586, Taiwan, R.O.C.

Tel: +886-2-8226-7786

Fax: +886-2-8226-7782

www.nexcom.com.tw

America

USA

NEXCOM USA

2883 Bayview Drive,
Fremont CA 94538, USA

Tel: +1-510-656-2248

Fax: +1-510-656-2158

Email: sales@nexcom.com

www.nexcom.com

Asia

Taiwan

Taichung Office

16F, No.250, Sec. 2,
Chongde Rd., Beitun Dist.,
Taichung City 406, R.O.C.

Tel: +886-4-2249-1179

Fax: +886-4-2249-1172

www.nexcom.com.tw

NEXCOM Japan

9F, Tamachi Hara Bldg.,4-11-5, Shiba Minato-ku,

Tokyo, 108-0014, Japan

Tel: +81-3-5419-7830

Fax: +81-3-5419-7832

Email: sales@nexcom-jp.com

www.nexcom-jp.com

China

NEXCOM China

2F, Block 4, Venus Plaza, Building 21,
ZhongGuanCun Software Park, No.8,
Dongbeiwang West Road, Haidian District,
Beijing, 100193, China

Tel: +86-10-8282-5880

Fax: +86-10-8282-5955

Email: sales@nexcom.cn

www.nexcom.cn

Shanghai Office

Room 1505, Greenland He Chuang Bldg.,
No. 450 Caoyang Rd.,
Shanghai, 200062, China

Tel: +86-21-6150-8008

Fax: +86-21-3251-6358

Email: sales@nexcom.cn

www.nexcom.cn

Nanjing Office

Hall C, Block 17, Tian Xing Cui Lang Bldg.,
No. 49 Yunnan North Rd.,
Nanjing, 210018, China

Tel: +86-25-8315-3486

Fax: +86-25-8315-3489

Email: sales@nexcom.cn

www.nexcom.cn

Shenzhen Office

Western Room 708, Block 210,
Tairan Industry & Trading Place, Futian Area,
Shenzhen, 518040, China

Tel: +86-755-833 7203

Fax: +86-755-833 7213

Email: sales@nexcom.cn

www.nexcom.cn

Wuhan Office

1-C 1804/1805, Mingze Liwan, No.519
South Luoshi Rd, Hongshan District,
Wuhan, 430070, China

Tel: +86-27-8722-7400

Fax: +86-27-8722-7400

Email: sales@nexcom.cn

www.nexcom.cn

Chengdu Office

9F, Shuxiangxie, Xuefu Garden,
No.12 Section 1, South Yihuan Rd.,
Chengdu, 610061, China
Tel: +86-28-8523-0186
Fax: +86-28-8523-0186
Email: sales@nexcom.cn
www.nexcom.cn

Europe

France

NEXCOM France

La Grande Arche-Paroi Nord
92044 Paris La Défense
France
Tel: +33 (0) 1 40 90 33 35
Fax: +33 (0) 1 40 90 31 01
Email: sales.fr@nexcom.eu
www.nexcom.eu

Germany

NEXCOM GmbH
Leopoldstraße Business Centre,
Leopoldstraße 244,
80807 Munich, Germany
Tel: +49-89-208039-278
Fax: +49-89-208039-279
Email: sales.de@nexcom.eu
www.nexcom.eu

Italy

NEXCOM ITALIA S.r.l
Via Gaudenzio Ferrari 29,
21047 Saronno (VA), Italia
Tel: +39 02 9628 0333
Fax: +39 02 9286 9215
Email: nexcomitalia@nexcom.eu
www.nexcomitalia.it

United Kingdom

NEXCOM EUROPE

10 Vincent Avenue,
Crownhill Business Centre,
Milton Keynes, Buckinghamshire
MK8 0AB, United Kingdom
Tel: +44-1908-267121
Fax: +44-1908-262042
Email: sales.uk@nexcom.eu
www.nexcom.eu

Package Contents

Before continuing, verify that the NISE 3640E package that you received is complete. Your package should have all the items listed in the following table.

Item	Part Number	Description	Qty
1	4NCPM00203X00	Terminal Blocks 2P Phoenix Contact:1803578	2
2	50311P0001X00	Price For Plastic Screw	1
3	50322P0002X00	Plastic Nut GIN LIAN:M6HW	1
4	60177A0311X00	NISB3640 Quick Reference Guide VER:A	1
5	6023344361X00	Cable EDI:231441090251-RS	1
6	60233POW33X00	DC Cord EDI:281040051051-RS	1
7	50311F0294X00	I Head Screw Long FEI:I2x4 NYLOK NIGP	4
8	50311F0326X00	Flat Head Screw Long FEI:F3x5 NYLOK NI+HEAT TREATMENT	4
9	50311F0143X00	Flat Head Screw Long FEI:F#6-32x8	1
10	50311F0100X00	Round Head Screw w/Spring+Flat Washer Long FEI:P3x6L	2
11	50311F0315X00	Round Head Screw Long FEI:P6#32T T10 NYLOK	1
12	602DCD0654X00	NISE3640E CD Driver VER:1.0	1

Ordering Information

The following information below provides ordering information for NISE 3640E Series.

- **Barebone**

NISE 3640E (P/N: 10J00364000X0)

- 3rd Generation Intel® Core™ i7 Fanless System with one PCIe x4 Expansion

NISE 3640E2 (P/N: 10J00364001X0)

- 3rd Generation Intel® Core™ i7 Fanless System with two PCIe x4 Expansion

NISE 3640P2 (P/N: 10J00364002X0)

- 3rd Generation Intel® Core™ i7 Fanless System with two PCI Expansion

NISE 3640P2E (P/N: 10J00364003X0)

- 3rd Generation Intel® Core™ i7 Fanless System with one PCI Expansion and one PCIe x4 Expansion

24V, 120W AC/DC power adapter w/o power cord (P/N: 7400120001X00)

Chapter 1: Product Introduction

Overview



Key Features

- Onboard 3rd generation Intel® Core™ i7 BGA processor
- Mobile Intel® QM77 PCH
- Support 1x 2.5" SATA HDD or 2x SATA DOM
- 2x Display Port; 1x VGA; 1x DVI-D; 2x USB3.0; 2x USB2.0
- 4x Intel® 82574IT GbE LAN ports; support WoL, teaming and PXE
- 2x DB9 for RS232/422/485; 1x DB44 Serial Port for 4x RS232
- 1x Internal Mini-PCIe socket supports optional Wi-Fi or 3.5G module
- 1x CFast socket; 1xSIM card socket;
- Support +24VDC input; support ATX Power mode
- 1x PCIe x4 expansion

Hardware Specifications

CPU Support

- Onboard 3rd generation Intel® Core™ i7 BGA processor
Core™ i7-3517UE, Dual Core, 1.7GHz, 4M Cache
- Mobile Intel® QM77 PCH

Main Memory

- On-board 2x DDR3/DDR3L SO-DIMM, supports up to 8GB DDR3/DDR3L 1333/1600 SDRAM, with un-buffered and non-ECC
- Pre-install 4G Industrial Grade Memory as the manufacture configuration for shipment

Display Option

- Three Independent Display (only support on 3rd Generation Processor)
 - Two Display Port and 1x VGA
 - Two Display Port and 1x DVI-D
- Dual Independent Display
 - VGA and DVI-D
 - Display Port and VGA

I/O Interface-Front

- ATX power on/off switch
- HDD access/ Power status/ LAN status LEDs
- 2x USB 3.0 (Blue color)
- 2x USB 2.0
- 2x DisplayPort (Can be converted to DVI-D or HDMI via active cables)
- 1x CFast socket
- 1x SIM card socket
- 2x Antenna holes

I/O Interface-Rear

- 2x DB9 for RS232/422/485
- 1x DB44 for 4x RS232
- 4x Intel® 82574IT GbE LAN ports; support WoL, teaming and PXE
- 1x DB15 VGA port
- 1x DVI-D
- 1x Line-out and 1x Mic-in
- 2-pin Remote Power on/off switch
- +24VDC Input

Storage Device

- 1x 2.5" SATA HDD or 2x SATA DOM (support 90°C horizontal type only)
- 1x CFast socket

Expansion Slot

- One PCIe x4 Expansion Slot
 - Add-on card length: 169mm max.
 - Power consumption: 10W/slot max.
- 1x Mini-PCIe socket (support optional Wi-Fi or 3.5G module)

Power Requirements

- ATX Power mode
- Support +24VDC Input
- Optional power adapter

Dimensions

- 215mm (W) x 272mm (D) x 93mm (H) without wall mount bracket (8.5" x 10.7" x 3.7")

Construction

- Aluminum Chassis with fanless design

Environment

- Operating temperature:
Ambient with air flow: -20°C to 60°C
(According to IEC60068-2-1, IEC60068-2-2, IEC60068-2-14)
- Storage temperature: -30°C to 85°C
- Relative humidity: 95% at 40°C
- Shock protection:
 - HDD: 20G, half sine, 11ms, IEC60068-2-27
 - CFast: 50G, half sine, 11ms, IEC60068-2-27
- Vibration protection w/ HDD Condition
 - Random: 0.5Grms @ 5~500 Hz according to IEC60068-2-64
 - Sinusoidal: 0.5Grms @ 5~500 Hz according to IEC60068-2-6

Certifications

- CE approval
- FCC Class A

Knowing Your NISE 3640E

Front Panel

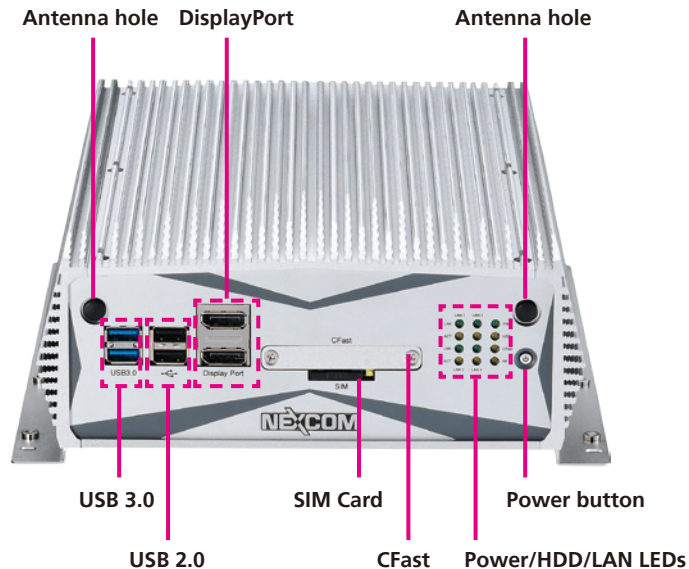

USB 3.0

Dual USB 3.0 ports to connect the system with USB 3.0/2.0 devices.

USB 2.0

Dual USB 2.0 ports to connect the system with USB 2.0 devices.

Antenna Hole

Used to install external antennas.

DisplayPort

Dual DisplayPort to connect the system with display devices.

SIM

Used to insert a SIM card.

CFAST Socket

Used to insert a CompactFlash card.

Power/HDD/LAN LEDs

Indicates the power status, hard drive and LAN activity of the system.

Power Button

Press to power-on or power-off the system.

Rear Panel

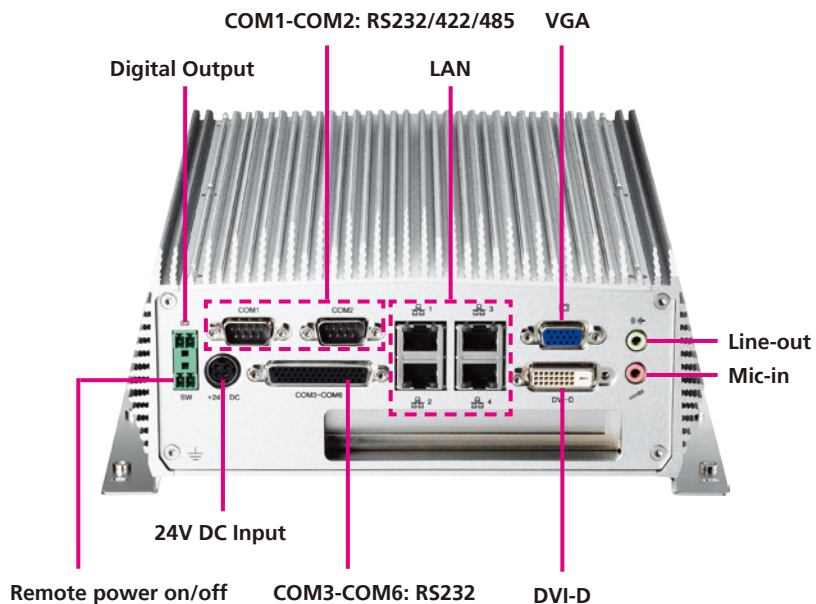

Remote Power On/Off

Used to connect a remote to power on/off the system.

Digital Output

Support S3 Wake on LAN.

24V DC Input

Used to plug a DC power cord.

COM1 and COM2

Two DB9 ports used to connect RS232/422/485 compatible devices.

COM3 to COM6

The DB44 port supports RS232 compatible serial devices.

LAN

Used to connect the system to a local area network.

VGA

Used to connect an analog VGA monitor.

DVI-D

Used to connect a digital LCD panel.

Line-out

Used to connect a headphone or a speaker.

Mic-in

Used to connect an external microphone.

Mechanical Dimensions

NISE 3600E

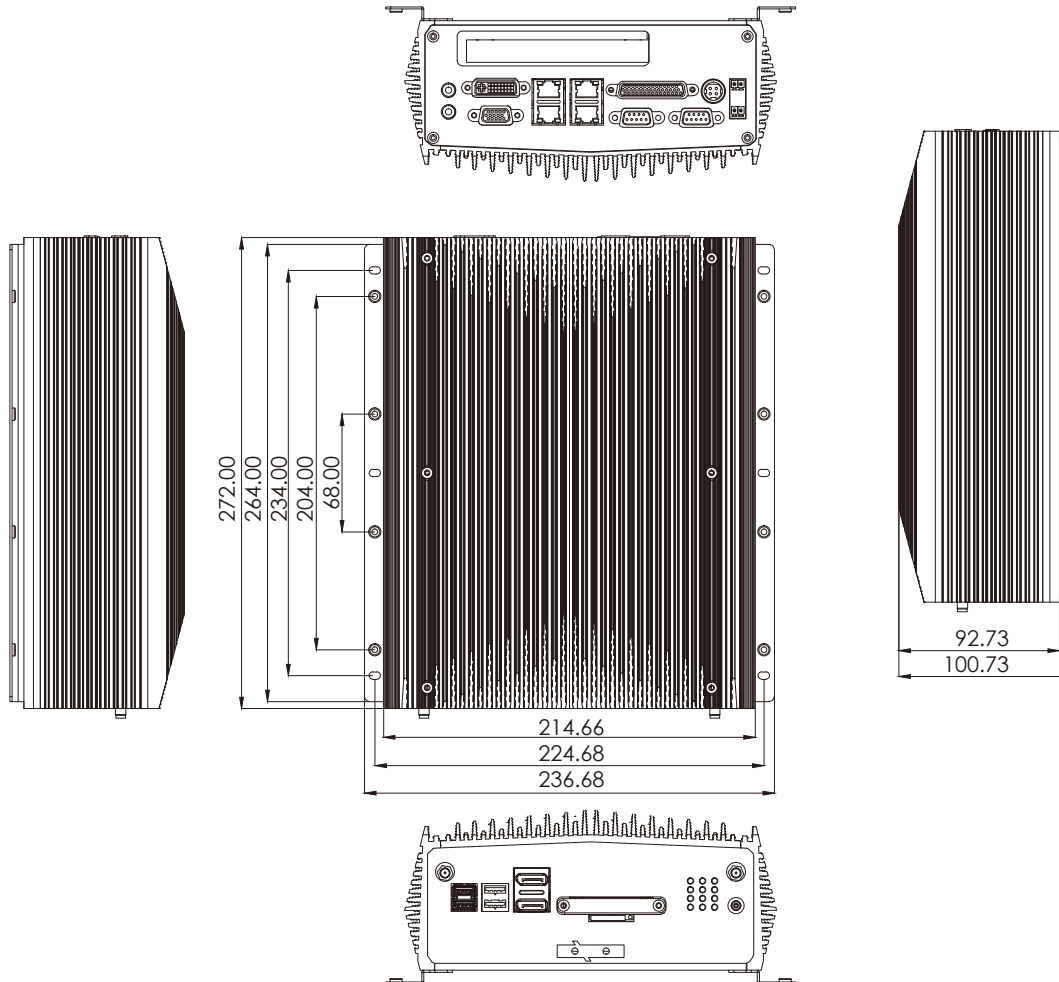

Chapter 2: Jumpers and Connectors

This chapter describes how to set the jumpers and connectors on the NISE 3640E motherboard.

Before You Begin

- Ensure you have a stable, clean working environment. Dust and dirt can get into components and cause a malfunction. Use containers to keep small components separated.
- Adequate lighting and proper tools can prevent you from accidentally damaging the internal components. Most of the procedures that follow require only a few simple tools, including the following:
 - A Philips screwdriver
 - A flat-tipped screwdriver
 - A set of jewelers screwdrivers
 - A grounding strap
 - An anti-static pad
- Using your fingers can disconnect most of the connections. It is recommended that you do not use needle-nosed pliers to disconnect connections as these can damage the soft metal or plastic parts of the connectors.
- Before working on internal components, make sure that the power is off. Ground yourself before touching any internal components, by touching a metal object. Static electricity can damage many of the electronic components. Humid environments tend to have less static electricity than

dry environments. A grounding strap is warranted whenever danger of static electricity exists.

Precautions

Computer components and electronic circuit boards can be damaged by discharges of static electricity. Working on computers that are still connected to a power supply can be extremely dangerous.

Follow the guidelines below to avoid damage to your computer or yourself:

- Always disconnect the unit from the power outlet whenever you are working inside the case.
- If possible, wear a grounded wrist strap when you are working inside the computer case. Alternatively, discharge any static electricity by touching the bare metal chassis of the unit case, or the bare metal body of any other grounded appliance.
- Hold electronic circuit boards by the edges only. Do not touch the components on the board unless it is necessary to do so. Don't flex or stress the circuit board.
- Leave all components inside the static-proof packaging that they shipped with until they are ready for installation.
- Use correct screws and do not over tighten screws.

Jumper Settings

A jumper is the simplest kind of electric switch. It consists of two metal pins and a cap. When setting the jumpers, ensure that the jumper caps are placed on the correct pins. When the jumper cap is placed on both pins, the jumper is short. If you remove the jumper cap, or place the jumper cap on just one pin, the jumper is open.

Refer to the illustrations below for examples of what the 2-pin and 3-pin jumpers look like when they are short (on) and open (off).

Two-Pin Jumpers: Open (Left) and Short (Right)

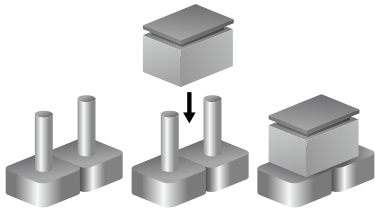

Three-Pin Jumpers: Pins 1 and 2 are Short

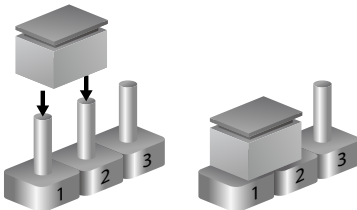

Locations of the Jumpers and Connectors for NISB 3640

NISB 3640

The figures below are the top and bottom views of the NISB 3640 main board which is the main board used in the NISE 3640E series. It shows the locations of the jumpers and connectors.

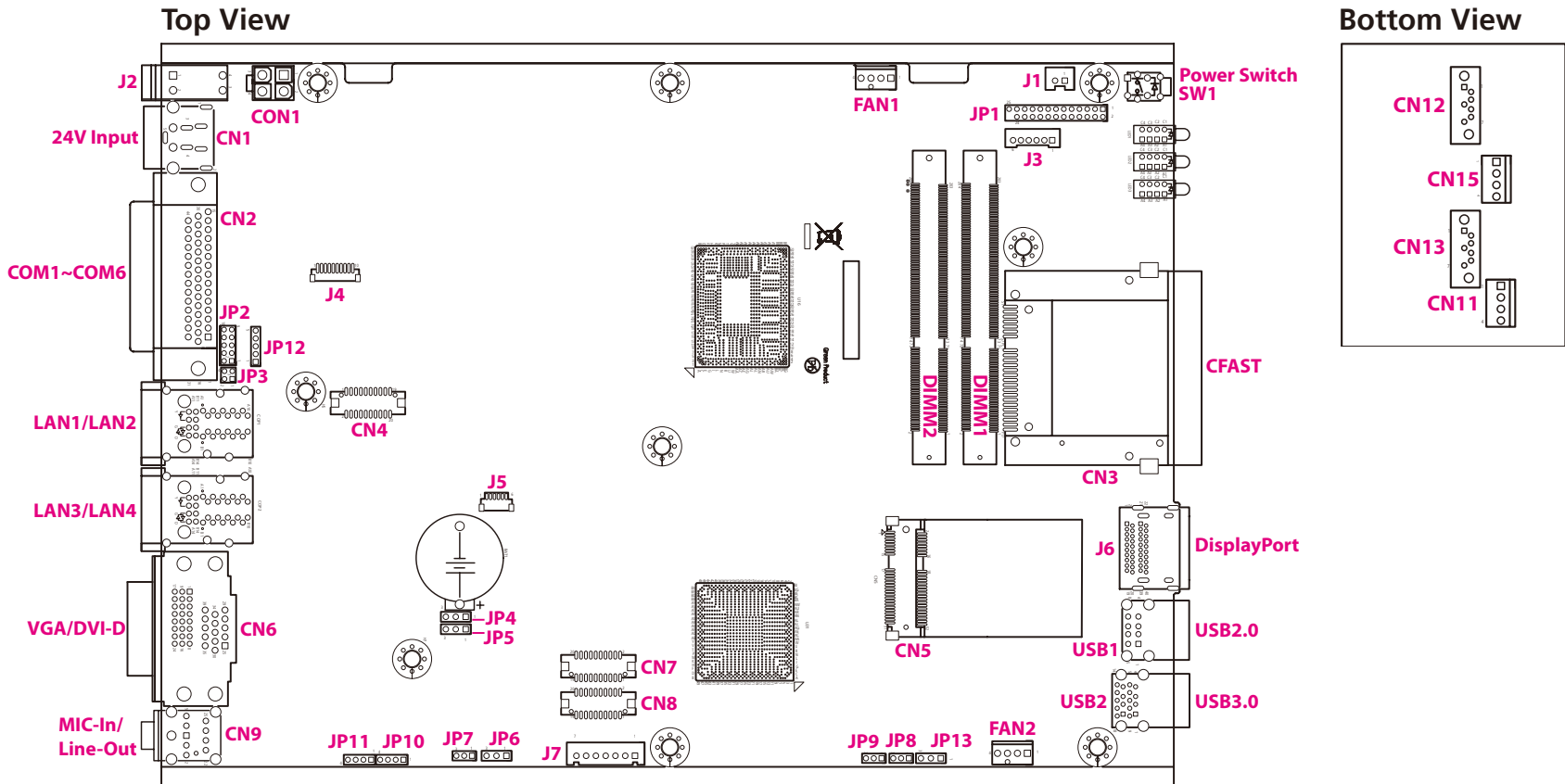

Jumpers

ME Pin Header

Connector type: 1x3 3-pin header, 2.54mm pitch

Connector location: JP5



Pin	Definition
1	SRTC_RST#_PU
2	SRTC_RST#
3	CLR_ME

COM4 RS232 RI# Pin Power Select

Connector type: 1x3 3-pin header, 2.0mm pitch

Connector location: JP12



Pin	Definition
1	VCC5_RI#
2	SP4_RI_T
3	+12V_RI#
4	SP4_RI_T
5	SP4_RI
6	NA

LVDS Power Pin Header

Connector type: 1x3 3-pin header, 2.54mm

Connector location: JP6



Pin	Definition
1	VCC3
2	VCCLCDIN
3	VCC5

1-2 On: default

Connector Pin Definitions

External I/O Interfaces - Front Panel

USB 3.0

Connector type: Dual USB 3.0 ports

Connector location: USB2

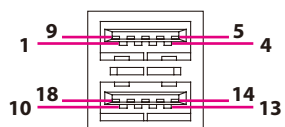

Pin	Definition	Pin	Definition
1	5VSB	2	USB_2N
3	USB_2P	4	GND
5	USB3_RX2_N	6	USB3_RX2_P
7	GND	8	USB3_TX2_N
9	USB3_TX2_P	10	5VSB
11	USB_3N	12	USB_3P
13	GND	14	USB3_RX3_N
15	USB3_RX3_P	16	GND
17	USB3_TX3_N	18	USB3_TX3_P
MH1	F_GND	MH2	F_GND
MH3	F_GND	MH4	F_GND

USB 2.0

Connector type: Dual USB 2.0 ports

Connector location: USB1

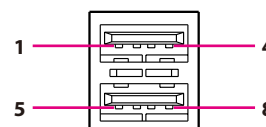

Pin	Definition	Pin	Definition
1	5VSB	2	USB2_8N
3	USB2_8P	4	GND
5	5VSB	6	USB2_9N
7	USB2_9P	8	GND
MH1	F_GND	MH2	F_GND
MH3	F_GND	MH4	F_GND

DisplayPort A

Connector type: DisplayPort
Connector location: J6A

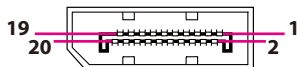

Pin	Definition	Pin	Definition
1	DPC_LANE0_P	2	GND_DP
3	DPC_LANE0_N	4	DPC_LANE1_P
5	GND_DP	6	DPC_LANE1_N
7	DPC_LANE2_P	8	GND_DP
9	DPC_LANE2_N	10	DPC_LANE3_P
11	GND_DP	12	DPC_LANE3_N
13	DPC_CONFIG1	14	DPC_CONFIG2
15	DPC_AUX_P	16	GND_DP
17	DPC_AUX_N	18	DPC_HPD
19	GND_DP	20	VCC3
MH1	F_GND	MH2	F_GND
MH3	F_GND	MH4	F_GND

DisplayPort B

Connector type: DisplayPort
Connector location: J6A

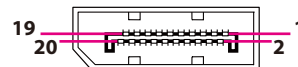

Pin	Definition	Pin	Definition
1	DPD_LANE0_P	2	GND_DP
3	DPD_LANE0_N	4	DPD_LANE1_P
5	GND_DP	6	DPD_LANE1_N
7	DPD_LANE2_P	8	GND_DP
9	DPD_LANE2_N	10	DPD_LANE3_P
11	GND_DP	12	DPD_LANE3_N
13	DPD_CONFIG1	14	DPD_CONFIG2
15	DPD_AUX_P	16	GND_DP
17	DPD_AUX_N	18	DPD_HPD
19	GND_DP	20	VCC3
MH1	F_GND	MH2	F_GND
MH3	F_GND	MH4	F_GND



While using DisplayPort to HDMI cable or DisplayPort to DVI cable, the cable must be active type.

CFast

Connector type: Standard CFast connector

Connector location: CN3

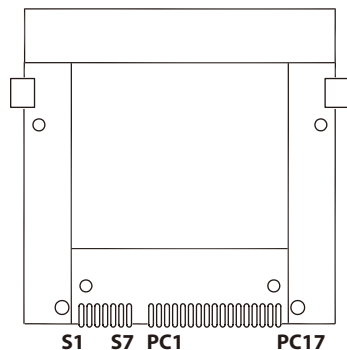

Pin	Definition	Pin	Definition
S1	GND	PC6	NC
S2	SATA_TXP3	PC7	GND
S3	SATA_TXN3	PC8	CFAST_LED1_C
S4	GND	PC9	CFAST_LED2_C
S5	SATA_RXN3	PC10	NC
S6	SATA_RXP3	PC11	NC
S7	GND	PC12	NC
PC1	CFAST_CDI	PC13	VCC3
PC2	GND	PC14	VCC3
PC3	NC	PC15	GND
PC4	NC	PC16	GND
PC5	NC	PC17	CFAST_CDO

SIM Card Connector

Connector location: IDE1

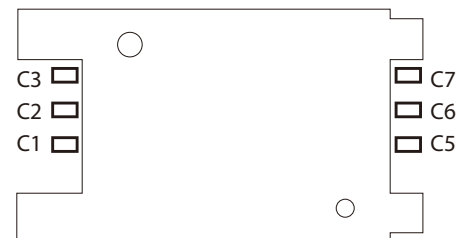

Pin	Definition	Pin	Definition
C1	UIM_PWR	C2	UIM_RESET
C3	UIM_CLK	C5	GND
C6	UIM_VPP	C7	UIM_DATA
SW1	NC	SW2	NC

Power Switch

Connector location: SW1



Pin	Definition	Pin	Definition
1	GND	2	PBT_PU
3	PBT_PU	4	GND
A1	PWR_SW_N	C1	PWR_SW_P
MH1	GND	MH2	GND

External I/O Interfaces - Rear Panel

Remote Power on/off Switch

Connector type: 4-pin switch

Connector location: J2

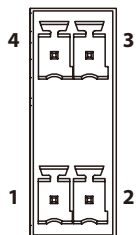

Pin	Definition	Pin	Definition
1	GND	2	PBT_PU
3	SLP_S3#	4	GND

DC-in Power Jack

Connector type: CompactFlash Type 2

Connector location: CN1

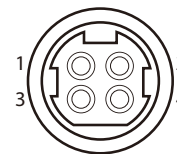

Pin	Definition	Pin	Definition
1	VIN	2	VIN
3	GND	4	GND
5	GND	MH1	R_GND
MH2	R_GND	MH3	R_GND
MH4	R_GND		

COM 1 and COM 2 Ports

Connector type: DB-9 port, 9-pin D-Sub

2x10 20-pin header, 1.25mm pitch

Connector location: CN4

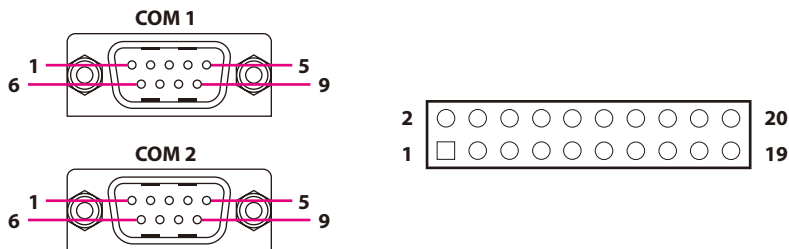

Pin	Definition	Pin	Definition
1	SP1_DCD	2	SP2_DCD
3	SP1_TXD	4	SP2_TXD
5	SP1_RTS	6	SP2_RTS
7	SP1_RI	8	SP2_RI
9	COM56_GND	10	COM56_GND
11	SP1_RXD	12	SP2_RXD
13	SP1_DTR	14	SP2_DTR
15	SP1_DSR	16	SP2_DSR
17	SP1_CTS	18	SP2_CTS
19	COM56_GND	20	COM56_GND
MH1	COM56_GND	MH2	COM56_GND

COM1 Connector Pin Definition

RS232		RS422		RS485	
Pin	Definition	Pin	Definition	Pin	Definition
1	SP1_DCD	1	SP1_TX-	1	SP1_DATA-
2	SP1_RXD	2	SP1_TX+	2	SP1_DATA+
3	SP1_TXD	3	SP1_RX+	3	NC
4	SP1_DTR	4	SP1_RX-	4	NC
5	GND	5	GND	5	GND
6	SP1_DSR	6	SP1_RTS-	6	NC
7	SP1_RTS	7	SP1_RTS+	7	NC
8	SP1_CTS	8	SP1_CTS+	8	NC
9	SP3_RI	9	SP1_CTS-	9	NC

COM2 Connector Pin Definition

RS232		RS422		RS485	
Pin	Definition	Pin	Definition	Pin	Definition
1	SP2_DCD	1	SP2_TX-	1	SP2_DATA-
2	SP2_RXD	2	SP2_TX+	2	SP2_DATA+
3	SP2_TXD	3	SP2_RX+	3	NC
4	SP2_DTR	4	SP2_RX-	4	NC
5	GND	5	GND	5	GND
6	SP2_DSR	6	SP2_RTS-	6	NC
7	SP2_RTS	7	SP2_RTS+	7	NC
8	SP2_CTS	8	SP2_CTS+	8	NC
9	SP3_RI	9	SP2_CTS-	9	NC

COM3 to COM6

Connector type: DB-44 port, 44-pin D-Sub

Connector location: CN2

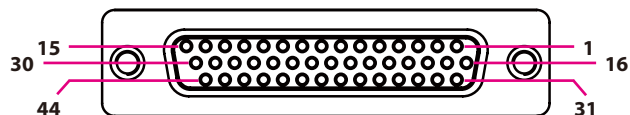

Pin	Definition	Pin	Definition
1	COM3_DCD	2	COM3_RXD
3	COM3_TXD	4	COM3_DTR
5	GND	6	COM3_DSR
7	COM3_RTS	8	COM3_CTS
9	COM3_RI	10	GND
11	COM4_DCD	12	COM4_RXD
13	COM4_TXD	14	COM4_DTR
15	GND	16	COM4_DSR
17	COM4_RTS	18	COM4_CTS
19	COM4_RI	20	GND
21	COM5_DCD	22	COM5_RXD
23	COM5_TXD	24	COM5_DTR
25	GND	26	COM5_DSR
27	COM5_RTS	28	COM5_CTS
29	COM5_RI	30	GND
31	COM6_DCD	32	COM6_RXD

Pin	Definition	Pin	Definition
33	COM6_TXD	34	COM6_DTR
35	GND	36	COM6_DSR
37	COM6_RTS	38	COM6_CTS
39	COM6_RI	40	GND
41	NC	42	NC
43	NC	44	NC
MH1	R_GND	MH2	R_GND

LAN1 and LAN2 Ports

Connector type: Dual RJ45 port with LEDs

Connector location: COP1B (LAN1) and COP1A (LAN2)

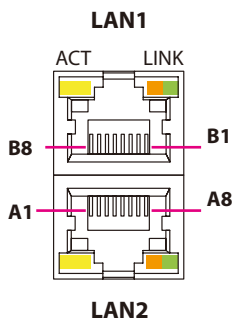

Act	Status
Flashing Yellow	Data activity
Off	No activity

Link	Status
Steady Green	1G network link
Steady Orange	100Mbps network link
Off	No link

LAN1

Pin	Definition	Pin	Definition
B1	MDI0P_LAN1	B2	MDI0N_LAN1
B3	MDI1P_LAN1	B4	MDI1N_LAN1
B5	MDI2P_LAN1	B6	MDI2N_LAN1
B7	MDI3P_LAN1	B8	MDI3N_LAN1
B9	VCC_LAN1	B10	GND
B11	3VSB	B12	LED_ACT#_LAN1
B13	LINK100#_LAN1	B14	LINK1G#_LAN1
MH4	R_GND	MH5	R_GND
MH6	R_GND		

LAN2

Pin	Definition	Pin	Definition
A1	MDI0P_LAN2	A2	MDI0N_LAN2
A3	MDI1P_LAN2	A4	MDI1N_LAN2
A5	MDI2P_LAN2	A6	MDI2N_LAN2
A7	MDI3P_LAN2	A8	MDI3N_LAN2
A9	VCC_LAN2	A10	GND
A11	3VSA	A12	LED_ACT#_LAN2
A13	LINK100#_LAN2	A14	LINK1G#_LAN2
MH4	R_GND	MH5	R_GND
MH6	R_GND		

LAN3 and LAN4 Ports

Connector type: Dual RJ45 port with LEDs

Connector location: COP2B (LAN3) and COP2A (LAN4)

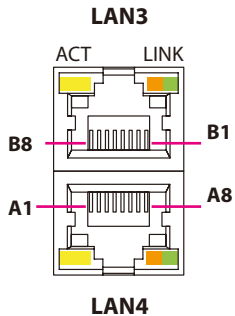

Act	Status
Flashing Yellow	Data activity
Off	No activity

Link	Status
Steady Green	1G network link
Steady Orange	100Mbps network link
Off	No link

LAN3

Pin	Definition	Pin	Definition
B1	MDI0P_LAN3	B2	MDI0N_LAN3
B3	MDI1P_LAN3	B4	MDI1N_LAN3
B5	MDI2P_LAN3	B6	MDI2N_LAN3
B7	MDI3P_LAN3	B8	MDI3N_LAN3
B9	VCC_LAN3	B10	GND
B11	3VSB	B12	LED_ACT#_LAN3
B13	LINK100#_LAN3	B14	LINK1G#_LAN3
MH4	R_GND	MH5	R_GND
MH6	R_GND		

LAN4

Pin	Definition	Pin	Definition
A1	MDI0P_LAN4	A2	MDI0N_LAN4
A3	MDI1P_LAN4	A4	MDI1N_LAN4
A5	MDI2P_LAN4	A6	MDI2N_LAN4
A7	MDI3P_LAN4	A8	MDI3N_LAN4
A9	VCC_LAN4	A10	GND
A11	3VSA	A12	LED_ACT#_LAN4
A13	LINK100#_LAN4	A14	LINK1G#_LAN4
MH4	R_GND	MH5	R_GND
MH6	R_GND		

VGA and DVI-D Connectors

Connector type: DB-15 port, 15-pin D-Sub (VGA)

24-pin D-Sub, 2.0mm-M-180 (DVI)

Connector location: CN6B (VGA) and CN6A (DVI-D)

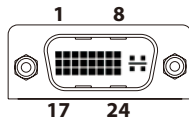
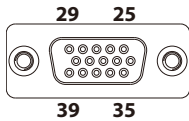

DVI-D

Pin	Definition	Pin	Definition
1	DVI_TDC2N	2	DVI_TDC2P
3	GND_DVI	4	NC
5	NC	6	DVI_DDC_CLK
7	DVI_DDC_DATA	8	NC
9	DVI_TDC1N	10	DVI_TDC1P
11	GND_DVI	12	NC
13	NC	14	VCC5
15	GND_DVI	16	DVI_HPD
17	DVI_TDC0N	18	DVI_TDC0P
19	GND_DVI	20	NC
21	NC	22	NC
23	DVI_CLK_P	24	DVI_CLK_N
MH1	R_GND	MH2	R_GND

VGA

Pin	Definition	Pin	Definition
25	VGA_RED	26	VGA_GREEN
27	VGA_BLUE	28	GND_DVI
29	GND_DVI	30	VGA_DET
31	GND_DVI	32	GND_DVI
33	VCC5	34	GND_DVI
35	GND_DVI	36	DDC_DATA
37	VGA_HSYNC	38	VGA_VSYNC
39	DDC_CLK	MH3	R_GND
MH4	R_GND		

Audio Connectors

Connector type: 2x 3.5mm TRS

Connector location: CN9A (Mic-in) and CN9B (Line-out)

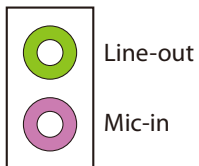

Pin	Definition	Pin	Definition
1	GND_AUD	2	MIC_L
3	GND_AUD	4	MIC-JD1
5	MIC_R	MH1	R_GND
MH2	R_GND	MH3	R_GND
MH4	R_GND	22	LOUT_LBR
23	GND_AUD	24	FRONT-JD
25	LOUT_RBR	MH1	NC

Internal Connectors

SIM Card Line-out Pin Header

Connector type: 1x3 3-pin header, 2.0mm

Connector location: JP8



Pin	Definition
1	LOUT_RL
2	LOUT_RR
3	ANGND

SIM Card Mic-in Pin Header

Connector type: 1x3 3-pin header, 2.0mm

Connector location: JP9



Pin	Definition
1	MIC_RL
2	MIC_RR
3	ANGND

DC-in Power Connector

Connector type: 2x2 4-pin header

Connector location: CON1

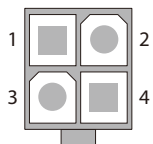

Pin	Definition
1	GND
2	GND
3	VIN
4	VIN

CMOS Pin Header

Connector type: 1x3 3-pin header, 2.54mm

Connector location: JP4



Pin	Definition
1	RTC_RST#_PU
2	RTC_RST#
3	CLR_CMOS

Reset JST Connector

Connector type: 1x2 2-pin header, 2.5mm pitch

Connector location: J1



Pin	Definition
1	PM_RESET#_J
2	GND

LVDS Channel A Connector

Connector type: 2x10 20-pin header, 1.25mm pitch

Connector location: CN7

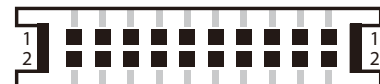

Pin	Definition	Pin	Definition
1	LVDS_DDC_CLK	2	LVDS_DDC_DATA
3	PANEL1_VDD	4	LVDSA_DATA0
5	LVDSA_DATA3	6	LVDSA_DATA#0
7	LVDSA_DATA#3	8	PANEL1_VDD
9	GND	10	LVDSA_DATA1
11	LVDSA_CLK	12	LVDSA_DATA#1
13	LVDSA_CLK#	14	GND
15	GND	16	PANEL1_BACKLIGHT
17	LVDSA_DATA2	18	PANEL1_BACKLIGHT
19	LVDSA_DATA#2	20	GND
MH1	GND	MH2	GND

LVDS Channel B Connector

Connector type: 2x10 20-pin header, 1.25mm pitch

Connector location: CN8

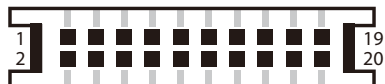

Pin	Definition	Pin	Definition
1	DDC_CLK	2	DDC_DATA
3	VDD	4	LVDSB_DATAP0
5	LVDSB_DATAP3	6	LVDSB_DATAN0
7	LVDSB_DATAN3	8	VDD
9	GND	10	LVDSB_DATAP1
11	LVDSB_CLKP	12	LVDSB_DATAN1
13	LVDSB_CLKN	14	GND
15	GND	16	PANEL1_BACKLIGHT
17	LVDSB_DATAP2	18	LVDSB_BACKLIGHT
19	LVDSB_DATAN2	20	GND
MH1	GND	MH2	GND

LVDS Backlight Connector

Connector type: 1x7 JST, 7-pin header, 2.5mm pitch

Connector location: J7

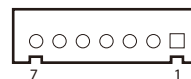

Pin	Definition	Pin	Definition
1	VCC5	2	PANEL1_BACKLIGHT
3	PANEL1_BACKLIGHT	4	L_BKLTCTL
5	GND	6	GND
7	LVDS_BKLT_EN		

Line-in 1 Pin Header

Connector type: 1x4 4-pin header, 2.5mm pitch

Connector location: JP10



Pin	Definition
1	LINE1-L
2	R_GND
3	LINE1-JD
4	LINE1-R

Line-in 2 Pin Header

Connector type: 1x4 4-pin header, 2.5mm pitch

Connector location: JP11



Pin	Definition
1	LINE2-L
2	R_GND
3	LINE2-JD
4	LINE2-R

SATA3 Connector 1

Connector type: Standard Serial ATAIII 7P (1.27mm, SATA-M-180)

Connector location: CN13

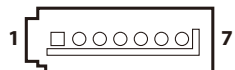

Pin	Definition	Pin	Definition
1	GND	2	SATA_TXP1
3	SATA_TXN1	4	GND
5	SATA_RXN1	6	SATA_RXP1
7	GND		

SATA3 Connector 2

Connector type: Standard Serial ATAIII 7P (1.27mm, SATA-M-180)

Connector location: CN12

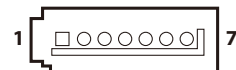

Pin	Definition	Pin	Definition
1	GND	2	SATA_TXP0
3	SATA_TXN0	4	GND
5	SATA_RXN0	6	SATA_RXP0
7	GND		

SATA3 Power Connector 1

Connector type: 1x4 4-pin Wafer, 2.54mm pitch
Connector location: CN11

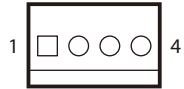

Pin	Definition
1	+12V
2	GND
3	GND
4	VCC5

SATA3 Power Connector 2

Connector type: 1x4 4-pin Wafer, 2.54mm pitch
Connector location: CN15

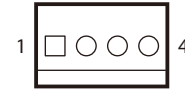

Pin	Definition
1	+12V
2	GND
3	GND
4	VCC5

GPS JST Connector

Connector type: 1x6 JST, 6-pin header, 1.00mm pitch

Connector location: J5



Pin	Definition	Pin	Definition
1	3VSB	2	GPS_LED
3	COM6_TXD	4	COM6_RXD
5	GND	6	VCC3
MH1	GND	MH2	GND

USB 2.0 JST Connector

Connector type: 1x6 JST, 6-pin header, 2.00mm pitch

Connector location: J3



Pin	Definition	Pin	Definition
1	5VSB	2	USB2_10N
3	USB2_10P	4	USB2_11N
5	USB2_11P	6	GND

PCIe x8 Slot

Connector type: PCIe x8 Slot

Connector location: SLOT1

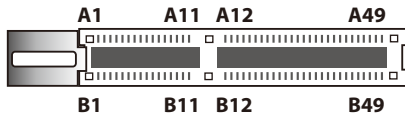

Pin	Definition	Pin	Definition
A1	PCIE_PRSNT1	B1	+12V
A2	+12V	B2	+12V
A3	+12V	B3	+12V
A4	GND	B4	GND
A5	NC	B5	SMB_CLK
A6	NC	B6	SMB_DATA
A7	NC	B7	GND
A8	NC	B8	VCC3
A9	VCC3	B9	NC
A10	VCC3	B10	3VSB
A11	PLT_RST_CPU_PCIE#	B11	PCIE_WAKE#
A12	GND	B12	NC
A13	CLK_PEG_P	B13	GND
A14	CLK_PEG_N	B14	PEG_TXP0
A15	GND	B15	PEG_TXN0
A16	PEG_RXP0	B16	GND
A17	PEG_RXN0	B17	PRSNT2_1
A18	GND	B18	GND
A19	NC	B19	PEG_TXP0
A20	GND	B20	PEG_TXN0
A21	PEG_RXP1	B21	GND

Pin	Definition	Pin	Definition
A22	PEG_RXN1	B22	GND
A23	GND	B23	PEG_TXP0
A24	GND	B24	PEG_TXN0
A25	PEG_RXP2	B25	GND
A26	PEG_RXN2	B26	GND
A27	GND	B27	PEG_TXP0
A28	GND	B28	PEG_TXN0
A29	PEG_RXP3	B29	GND
A30	PEG_RXN3	B30	NC
A31	GND	B31	PRSNT2_2
A32	NC	B32	GND
A33	NC	B33	PEG_TXP0
A34	GND	B34	PEG_TXN0
A35	PEG_RXP4	B35	GND
A36	PEG_RXN4	B36	GND
A37	GND	B37	PEG_TXP0
A38	GND	B38	PEG_TXN0
A39	PEG_RXP5	B39	GND
A40	PEG_RXN5	B40	GND
A41	GND	B41	PEG_TXP0
A42	GND	B42	PEG_TXN0
A43	PEG_RXP6	B43	GND
A44	PEG_RXN6	B44	GND
A45	GND	B45	PEG_TXP0
A46	GND	B46	PEG_TXN0
A47	PEG_RXP7	B47	GND
A48	PEG_RXN7	B48	PRSNT2_3
A49	GND	B49	GND

Mini-PCIe Connector

Connector location: CN5

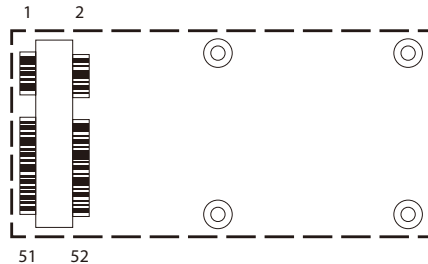

Pin	Definition	Pin	Definition
1	MIC_R	2	3VSB
3	MIC_L	4	GND
5	LOUT_R	6	V1_5
7	LOUT_L	8	3VSB
9	GND	10	UIM_DATA
11	PCIE_MINI_CLK_N	12	UIM_CLK
13	PCIE_MINI_CLK_P	14	UIM_RESET
15	GND	16	UIM_VCCP
17	GND	18	GND
19	GND	20	3VSB
21	GND	22	PLT_RST
23	PCIE_MINI_RXN	24	3VSB
25	PCIE_MINI_RXP	26	GND

Pin	Definition	Pin	Definition
27	GND	28	V1_5
29	GND	30	SMB_CLK
31	PCIE_MINI_TXN	32	SMB_DATA
33	PCIE_MINI_TXP	34	GND
35	GND	36	USB_N
37	GND	38	USB_P
39	3VSB	40	GND
41	3VSB	42	WLAN_ACT
43	GND	44	WLAN_ACT
45	NA	46	WLAN_ACT
47	NA	48	V1_5
49	NA	50	GND
51	NA	52	3VSB

GPIO Pin Header

Connector type: 2x5 10-pin header, 2.00mm pitch

Connector location: JP2

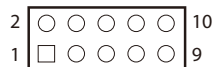

Pin	Definition	Pin	Definition
1	VCC5	2	GND
3	GPO24	4	GPI20
5	GPO25	6	GPI21
7	GPO26	8	GPI22
9	GPO27	10	GPI23

GPIO LED Pin Header

Connector type: 2x2 4-pin header, 2.00mm pitch

Connector location: JP3

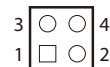

Pin	Definition
1	GPO24
2	GND
3	GPO25
4	GND

Smart Fan1 Connector

Connector type: 1x4 4-pin Wafer, 2.54mm pitch

Connector location: FAN1



Pin	Definition
1	GND
2	+12V
3	FAN_TAC1
4	FAN_CTL1

Smart Fan2 Connector

Connector type: 1x4 4-pin Wafer, 2.54mm pitch

Connector location: FAN2



Pin	Definition
1	GND
2	+12V
3	FAN_TAC2
4	FAN_CTL2

External LED Pin Header

Connector type: 2x13 26-pin, 2.00mm pitch

Connector location: JP1

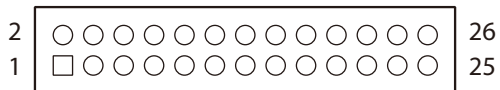

Pin	Definition	Pin	Definition
1	PWR_LED_N	2	PWR_LED_P
3	PCH_SATA_LED#	4	LED_HDDP
5	CFAST_ACCESS	6	CFAST_LED_P
7	RF_LED_N	8	RF_LED_P
9	LAN1_LINK#	10	LAN1_LINKP
11	LED_ACT#_LAN1	12	LAN1_ACTP
13	LAN2_LINK#	14	LAN2_LINKP
15	LED_ACT#_LAN2	16	LAN2_ACTP
17	LAN3_LINK#	18	LAN3_LINKP
19	LED_ACT#_LAN3	20	LAN3_ACTP
21	LAN4_LINK#	22	LAN4_LINKP
23	LED_ACT#_LAN4	24	LAN4_ACTP
25	NC	26	NC

Power/PSON Header

Connector type: 1x4 4-pin header, 3.81mm pitch

Connector location: J2



Pin	Definition	Pin	Definition
1	GND	2	PBT_PU
3	SLP_S3#	4	GND

80 Port

Connector type: 1x10 10-pin header, 1.00mm pitch

Connector location: J4



Pin	Definition	Pin	Definition
1	GND	2	PLT_RST_SIO#
3	CLK_PCI_P80	4	LPC_FRAME#
5	LPC_AD3	6	LPC_AD2
7	LPC_AD1	8	LPC_ADO
9	3VSB	10	3VSB
MH1	GND	MH2	GND

External SMBus

Connector type: 1x3 3-pin header, 2.00mm pitch

Connector location: JP7



Pin	Definition
1	SMB_CLK
2	SMB_DATA
3	GND

Flash BIOS CON

Connector type: 2x3 6-pin, 2.00mm pitch

Connector location: JFW1

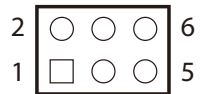

Pin	Definition	Pin	Definition
1	VSPI	2	GND
3	BIOS_SPI_CS#0	4	BIOS_SPI_CLK
5	BIOS_SPI_SO	6	BIOS_SPI_SI

Mini-PCle Slot

Connector location: CN14

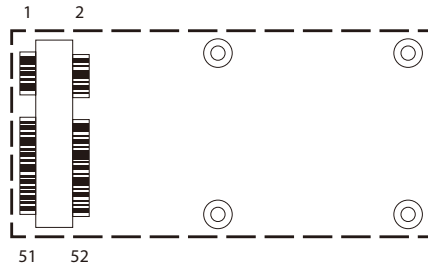

Pin	Definition	Pin	Definition
1	PCIE_WAKE#	2	3VSB
3	NC	4	GND
5	NC	6	V1_5
7	PCIE_MINI2_CLKREQ#A	8	NC
9	GND	10	NC
11	CLK_PCIE_MINI2_N	12	NC
13	CLK_PCIE_MINI2_P	14	NC
15	GND	16	NC
17	NC	18	GND
19	NC	20	3VSB_MINI1
21	GND	22	PLT_RST_SP338#
23	PCIE_RXN2_MINI_PCIE	24	3VSB
25	PCIE_RXP2_MINI_PCIE	26	GND

Pin	Definition	Pin	Definition
27	GND	28	V1_5
29	GND	30	SMB_CLK
31	PCIE_TXN2_MINI_PCIE	32	SMB_DATA
33	PCIE_TXP2_MINI_PCIE	34	GND
35	GND	36	USB_1N
37	GND	38	USB_1P
39	3VSB_MINI1	40	GND
41	3VSB_MINI1	42	NA
43	GND	44	NA
45	NA	46	NA
47	NA	48	V1_5
49	NA	50	GND
51	NA	52	3VSB_MINI1

Chapter 3: System Setup

Mount the System to the Wall

The wallmount brackets provides a convenient and economical way of mounting the system on the wall.

1. The mounting holes are located at the bottom of the system. Secure the brackets on each side of the system using the provided mounting screws.
2. Now mount the system on the wall by fastening screws through the bracket's mounting holes.

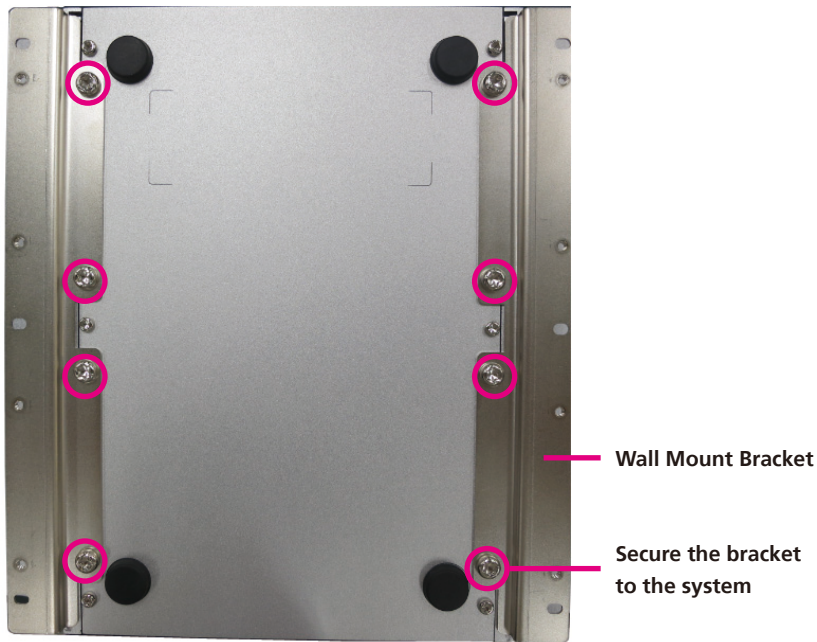

Removing the Chassis Bottom Cover

Note: Installation for SATA Hard Drive and SATA DOM only



Prior to removing the chassis cover, make sure the unit's power is off and disconnected from the power sources to prevent electric shock or system damage.

1. With the bottom side of the chassis facing up, remove the mounting screw of the bottom cover and then put them in a safe place for later use.
2. Lift up the cover and remove it from the chassis.

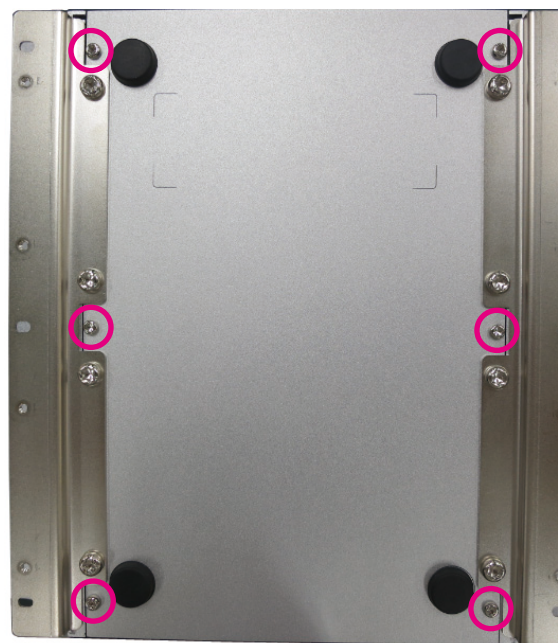

Installing a SATA Hard Drive

1. Remove 4 screws around the empty HDD bracket.

2. Use the provided screws to secure the drive in place.

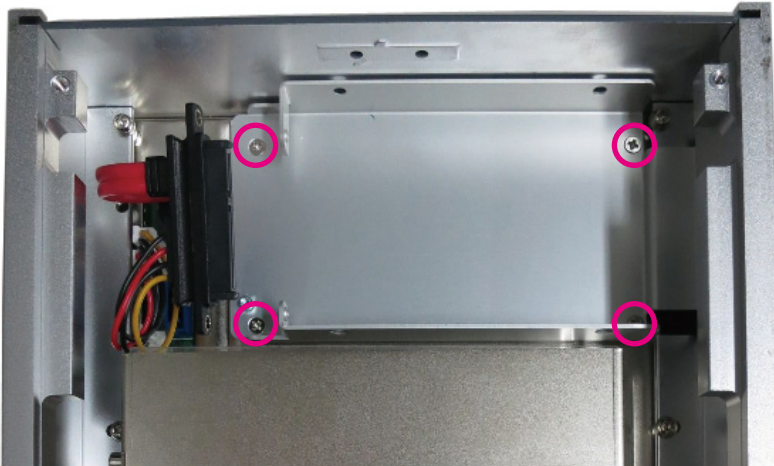

3. Connect the SATA data/power cable and fasten the cable to HDD bracket by provided screw.

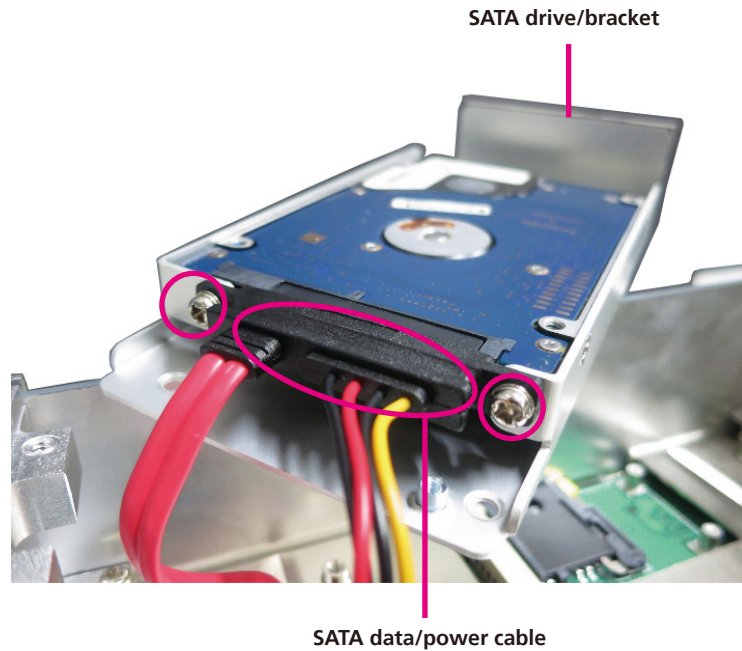

4. Insert the HDD bracket onto the panel at a 45 degree angle, and gently slide the HDD bracket in place.

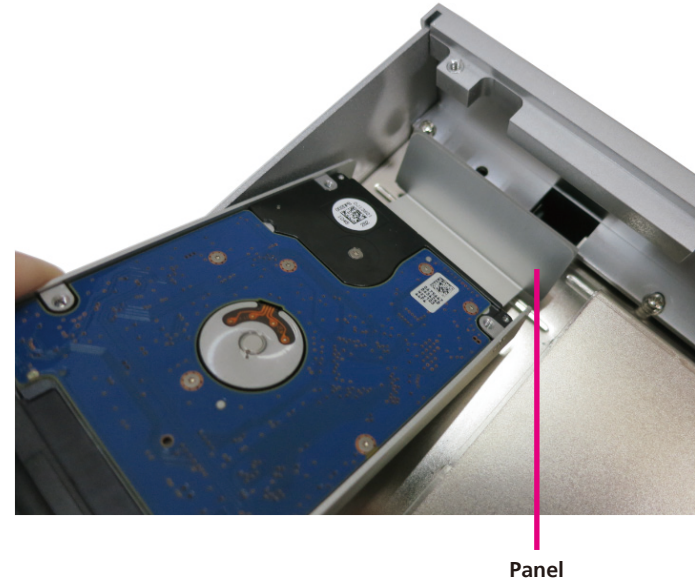

5. Connect the SATA data/power cable to the connector on the SATA drive then secure the HDD bracket to its original place.

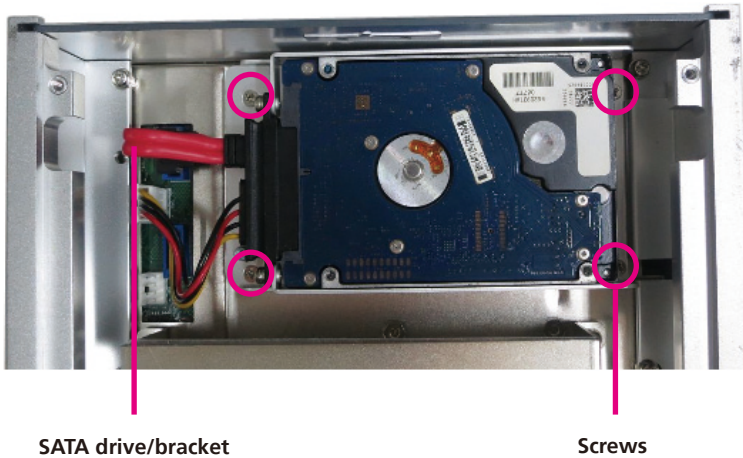

Installing a SATA DOM

1. Remove the HDD bracket before installing a SATA DOM.
2. Locate the SATA connector on the board and fasten with the copper post included in the accessory package.

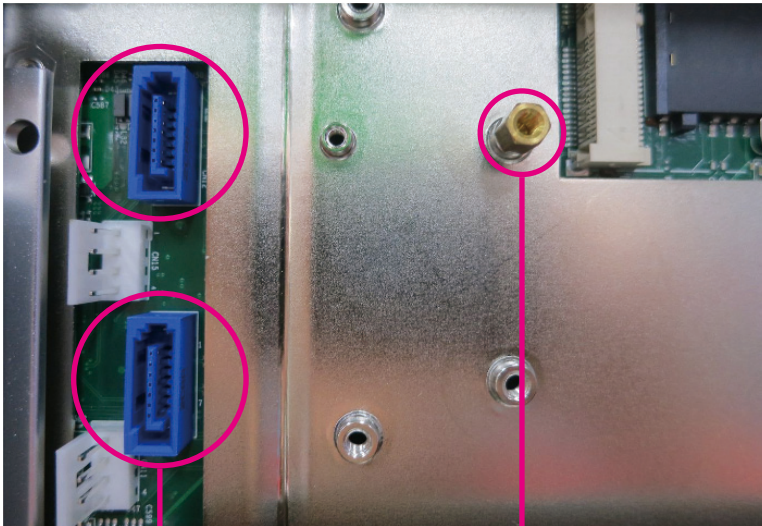

SATA Connector/
SATA Power Connector

Copper Post

3. Connect one side of power cable to the SATA DOM.

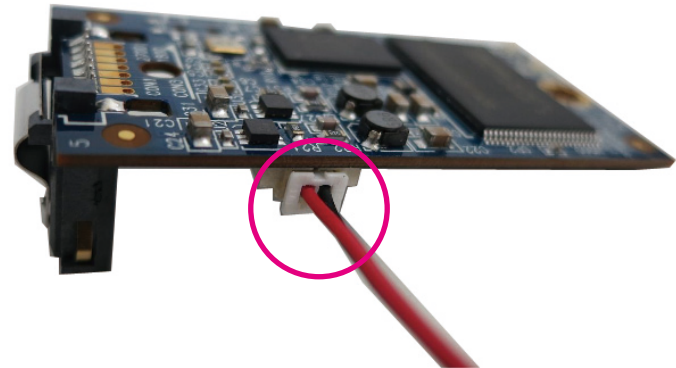

4. Install the SATA DOMM and connect the other side of SATA power cable to the SATA power connector.



The SATA DOMM is locked after installation. Be sure to push the lock when releasing.

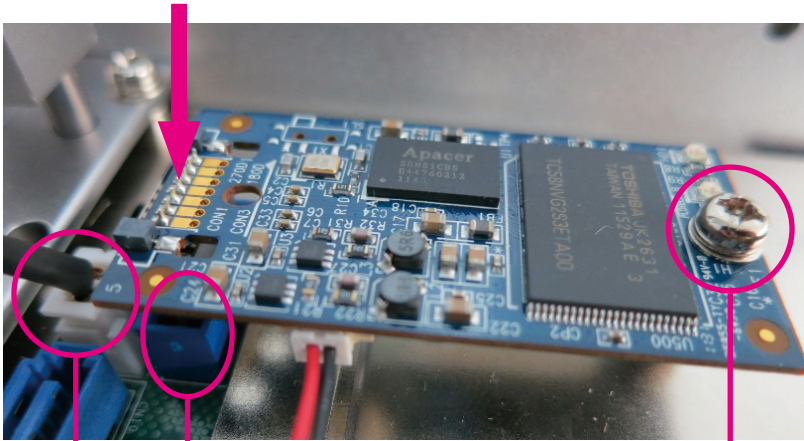

SATA Connector
Power Connector

Screw

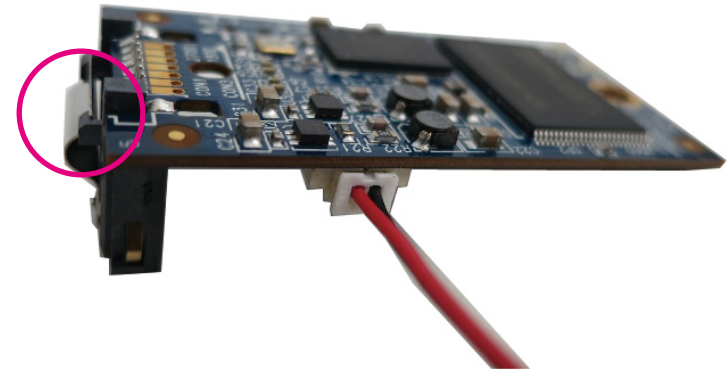

5. Fasten the screw on the top of copper post.

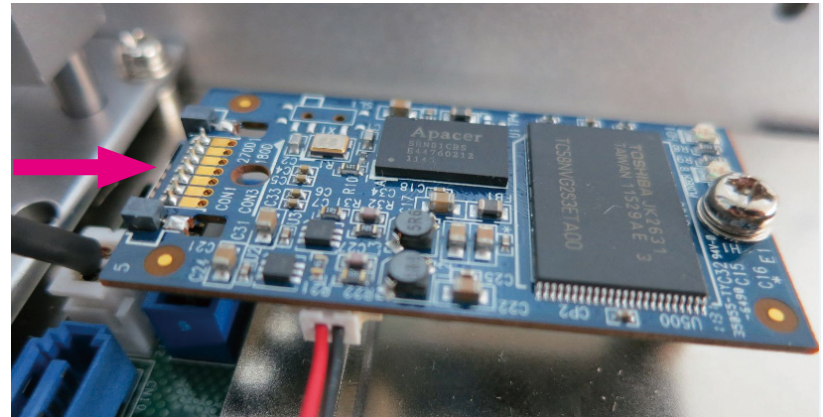

Installing a PCIe/PCI Expansion Card

Note:

NISE 3640E is equipped with one PCIe x4 expansion slot.
 NISE 3640E2 is equipped with two PCIe x4 expansion slot.
 NISE 3640P2 is equipped with two PCI expansion slot.
 NISE 3640P2E is equipped with one PCIe x4 expansion slot and one PCI expansion slot.

1. Remove the chassis bottom cover.
2. Remove screws of the riser bracket.

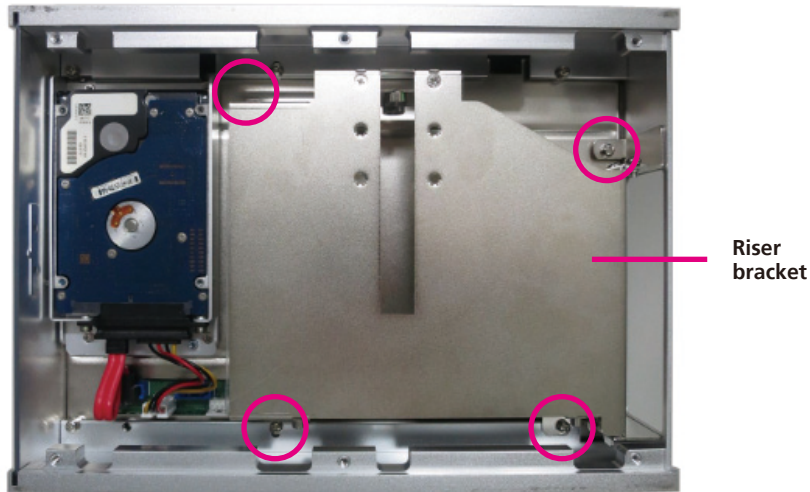

Note: Example shown is NISE 3640P2E



3. Remove screws on the expansion cover.

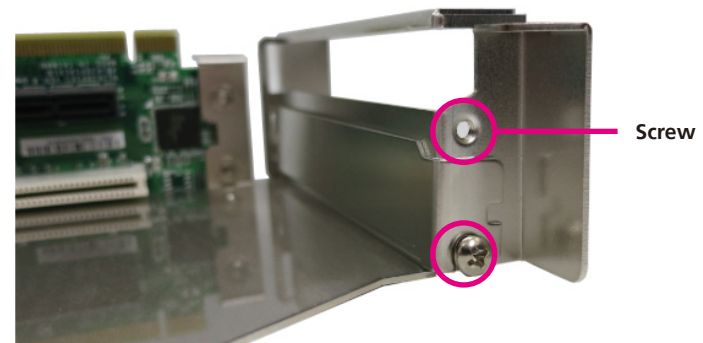

Note: Example shown is NISE 3640P2E

4. Insert PCIe/PCI expansion card and fasten the screw.

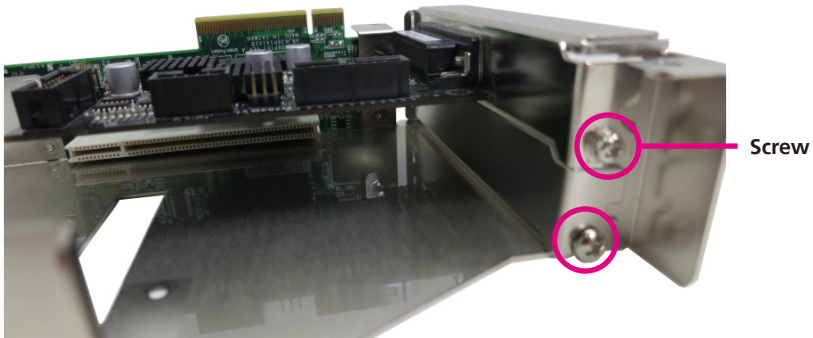

5. Secure the riser bracket to its original position.

Removing the Chassis Top Cover

1. Remove the mounting screw on the top cover and then put them in a safe place for later use.

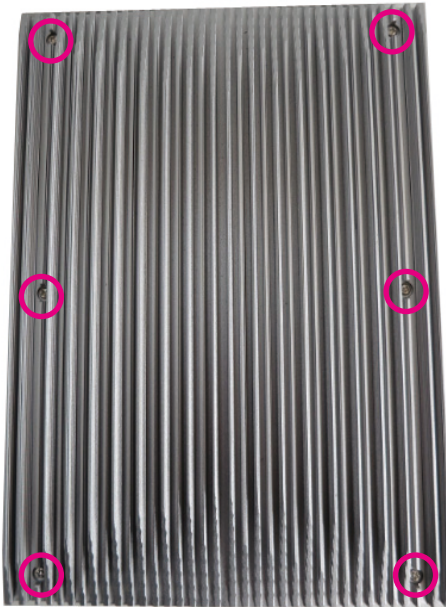

2. Lift up the cover and remove it from the chassis.

Installing a SO DIMM

1. Locate the SO DIMM socket.

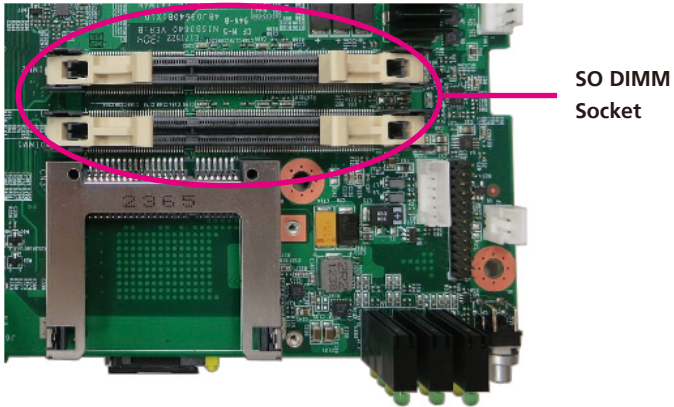

2. Release the lock on the SO DIMM socket.

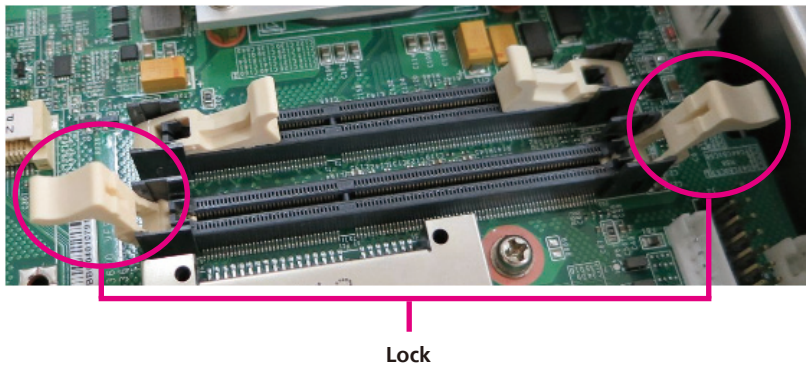

3. Insert the module into the socket at a 90 degree angle. Apply firm even pressure to each end of the module until it slips into the socket.



4. While pushing the SO DIMM into the position, the lock will close automatically.



Installing a Wireless LAN Module (half-size)

1. Locate the Mini PCI Express slot on the board.

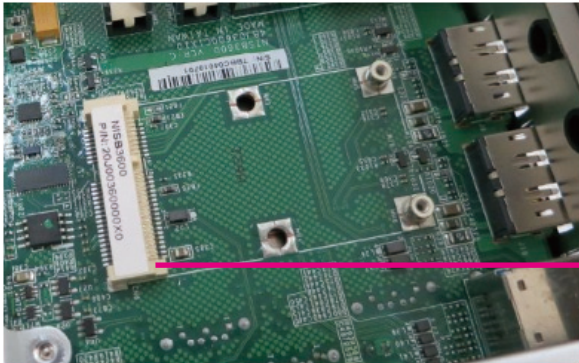

Mini PCI Express Slot

2. Fasten the Wireless LAN module with the mini PCI express bracket.

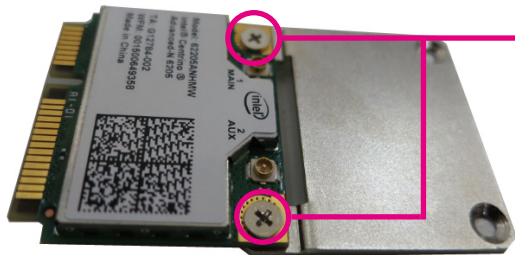

Screw

3. Insert the wireless LAN module into the Mini PCI Express slot at a 45 degree angle until the gold-plated connector on the edge of the module completely disappears inside the slot.



4. Push the module down and then secure it with mounting screws.



Screw

Installing a Wireless LAN Module (full-size)

1. Locate the Mini PCI Express slot on the board.

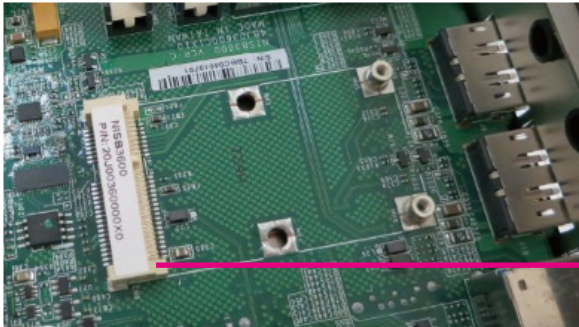

Mini PCI Express Slot

2. Insert the wireless LAN module into the Mini PCI Express slot at a 45 degree angle until the gold-plated connector on the edge of the module completely disappears inside the slot.



3. Push the module down and then secure it with mounting screws.



Screw

Installing a GPS Module

1. Locate the GPS module install location and remove the two screws on the board.

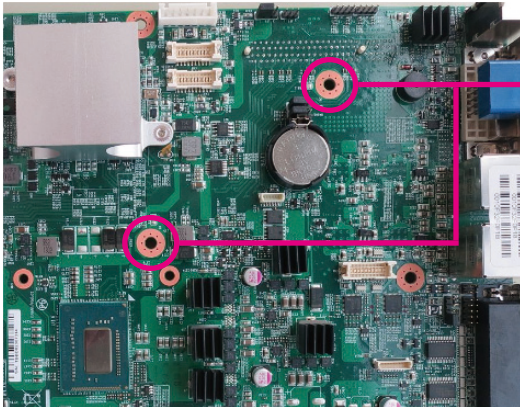

Screw

2. Fasten the copper post included in the accessory bag onto the screw holes.

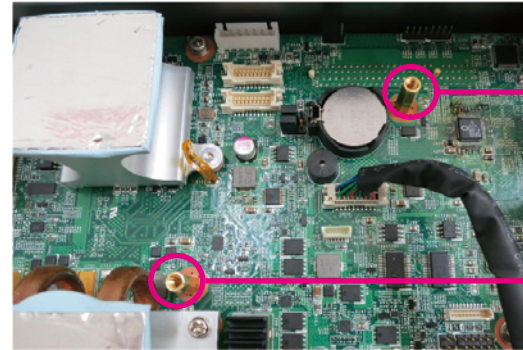

Copper Post

3. Secure the GPS bracket on the copper post.

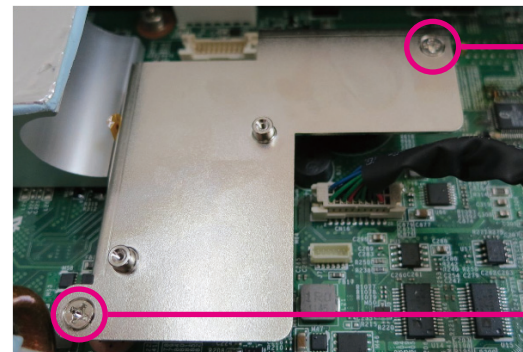

Screws

4. Secure the GPS module to the bracket.

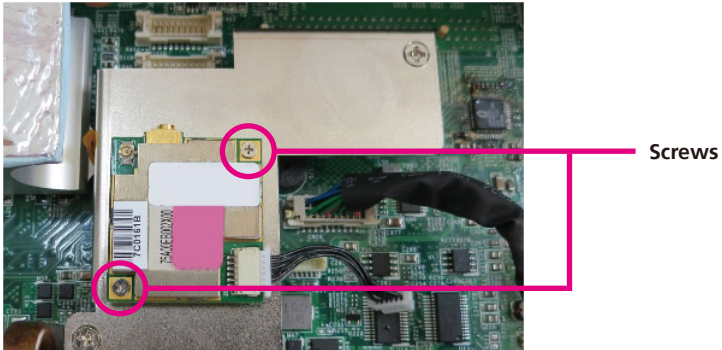

5. Connect the GPS cable

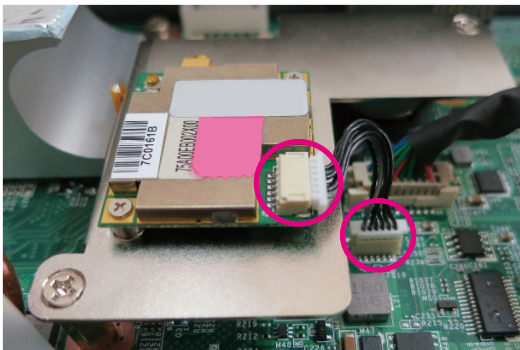

Installing Antennas

1. Remove the antenna hole covers located in the front panel.



Antenna hole covers

Antenna hole covers

2. Insert the antenna jack through the antenna hole.



Antenna jack

3. Insert the 2 rings (ring 1 and ring2) onto the antenna jack.

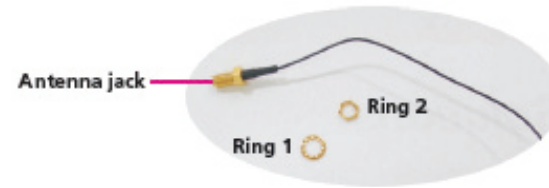

4. Attach one end of the RF cable onto the module.

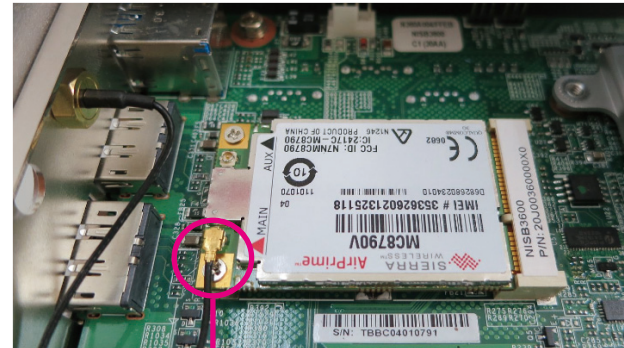

RF Cable

Installing a SIM Card

1. Locate the SIM card on the front panel.



SIM Card

2. Push the yellow button to release the SIM card holder.

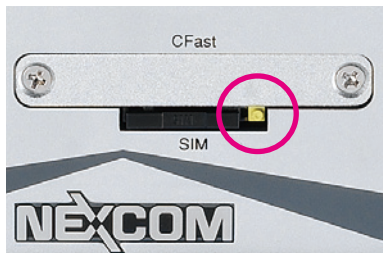

3. Place the SIM card to the SIM card holder and secure it to the original position.



Installing a CompactFlash Card

1. The CompactFlash socket is located at the front side of the chassis.

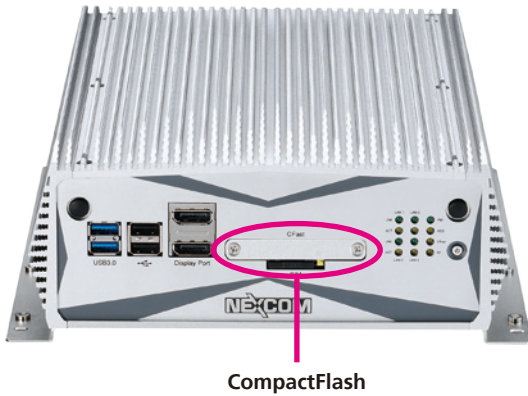

2. Remove the mounting screws and cover of the CompactFlash socket.

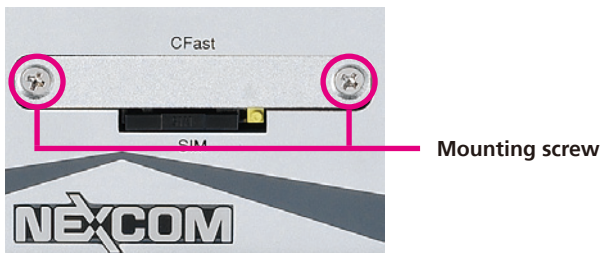

3. Insert the CFast
4. Fasten the cover after installation.

Chapter 4: BIOS Setup

This chapter describes how to use the BIOS setup program for the NISE 3640E series. The BIOS screens provided in this chapter are for reference only and may change if the BIOS is updated in the future.

To check for the latest updates and revisions, visit the NEXCOM Web site at www.nexcom.com.tw.

About BIOS Setup

The BIOS (Basic Input and Output System) Setup program is a menu driven utility that enables you to make changes to the system configuration and tailor your system to suit your individual work needs. It is a ROM-based configuration utility that displays the system's configuration status and provides you with a tool to set system parameters.

These parameters are stored in non-volatile battery-backed-up CMOS RAM that saves this information even when the power is turned off. When the system is turned back on, the system is configured with the values found in CMOS.

With easy-to-use pull down menus, you can configure such items as:

- Hard drives, diskette drives, and peripherals
- Video display type and display options
- Password protection from unauthorized use
- Power management features

The settings made in the setup program affect how the computer performs. It is important, therefore, first to try to understand all the setup options, and second, to make settings appropriate for the way you use the computer.

When to Configure the BIOS

- This program should be executed under the following conditions:
 - When changing the system configuration
 - When a configuration error is detected by the system and you are prompted to make changes to the setup program
 - When resetting the system clock
 - When redefining the communication ports to prevent any conflicts
 - When making changes to the Power Management configuration
 - When changing the password or making other changes to the security setup

Normally, CMOS setup is needed when the system hardware is not consistent with the information contained in the CMOS RAM, whenever the CMOS RAM has lost power, or the system features need to be changed.

Default Configuration

Most of the configuration settings are either predefined according to the Load Optimal Defaults settings which are stored in the BIOS or are automatically detected and configured without requiring any actions. There are a few settings that you may need to change depending on your system configuration.

Entering Setup

When the system is powered on, the BIOS will enter the Power-On Self Test (POST) routines. These routines perform various diagnostic checks; if an error is encountered, the error will be reported in one of two different ways:













- If the error occurs before the display device is initialized, a series of beeps will be transmitted.
- If the error occurs after the display device is initialized, the screen will display the error message.

Powering on the computer and immediately pressing allows you to enter Setup. Another way to enter Setup is to power on the computer and wait for the following message during the POST:

TO ENTER SETUP BEFORE BOOT PRESS  +  + 

Press the  key to enter Setup:

Legends

Key	Function
 	Moves the highlight left or right to select a menu.
 	Moves the highlight up or down between sub-menus or fields.
	Exits the BIOS Setup Utility.
	Scrolls forward through the values or options of the highlighted field.
	Scrolls backward through the values or options of the highlighted field.
	Selects a field.
	Displays General Help.
	Load previous values.
	Load optimized default values.
	Saves and exits the Setup program.
	Press <Enter> to enter the highlighted sub-menu

Scroll Bar

When a scroll bar appears to the right of the setup screen, it indicates that there are more available fields not shown on the screen. Use the up and down arrow keys to scroll through all the available fields.

Submenu

When “▶” appears on the left of a particular field, it indicates that a submenu which contains additional options are available for that field. To display the submenu, move the highlight to that field and press  .

BIOS Setup Utility

Once you enter the AMI BIOS Setup Utility, the Main Menu will appear on the screen. The main menu allows you to select from several setup functions and one exit. Use arrow keys to select among the items and press  to accept or enter the submenu.

Main

The Main menu is the first screen that you will see when you enter the BIOS Setup Utility.



Aptio Setup Utility - Copyright (C) 2011 American Megatrends, Inc.					
Main	Advanced	Chipset	Boot	Security	Save & Exit
BIOS Information		American Megatrends		Set the Date. Use Tab to switch between Date elements.	
BIOS Vendor	4.6.5.3				
Core Version	UEFI 2.3; PI 1.2				
Compliancy	N364-004				
Project Version	03/05/2013 15:27:37				
Build Date and Time					
Memory Information					
Memory Frequency	1600 Mhz				
Total Memory	8192 MB (DDR3)				
DIMM#0	4096 MB (DDR3)				
DIMM#2	4096 MB (DDR3)				
ME Firmware Information				←→: Select Screen ↑↓: Select Item Enter: Select +/-: Change Opt. F1: General Help F2: Previous Values F3: Optimized Defaults F4: Save & Exit ESC: Exit	
ME FW Version	8.0.3.1427				
ME Firmware Mode	Normal Mode				
ME Firmware SKU	1.5MB				
System Date	[Mon 03/25/2013]				
System Time	[13:27:32]				
Version 2.14.1219. Copyright (C) 2011 American Megatrends, Inc.					

System Date

The date format is <day>, <month>, <date>, <year>. Day displays a day, from Monday to Sunday. Month displays the month, from January to December. Date displays the date, from 1 to 31. Year displays the year, from 1999 to 2099.

System Time

The time format is <hour>, <minute>, <second>. The time is based on the 24-hour military-time clock. For example, 1 p.m. is 13:00:00. Hour displays hours from 00 to 23. Minute displays minutes from 00 to 59. Second displays seconds from 00 to 59.

Advanced

The Advanced menu allows you to configure your system for basic operation. Some entries are defaults required by the system board, while others, if enabled, will improve the performance of your system or let you set some features according to your preference.



Setting incorrect field values may cause the system to malfunction.



ACPI Settings

This section is used to configure ACPI Settings.

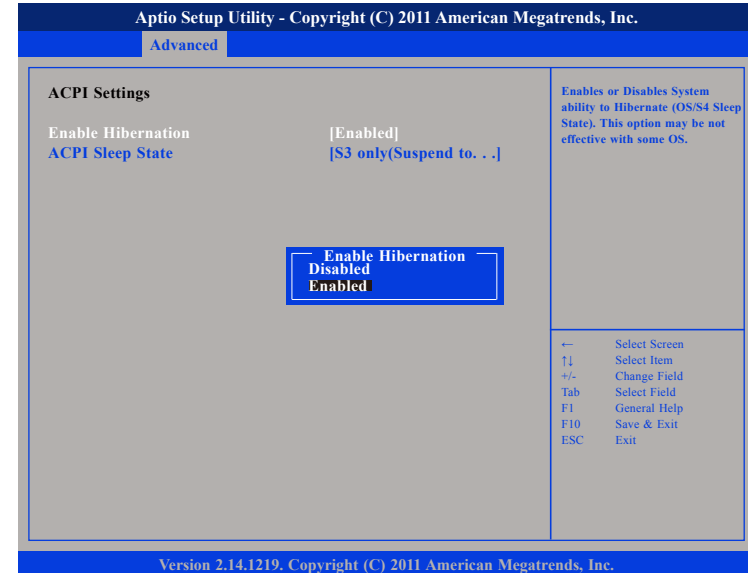

Enable Hibernation

Enables or disables system ability to hibernate (OS/S4 Sleep State). This option may not be effective with some OS.

ACPI Sleep State



Select the highest ACPI sleep state the system will enter when the suspend button is pressed. The options are Suspend Disabled, S1 (CPU Stop Clock) and S3 (Suspend to RAM).

Wake System with Fixed Time

This section is used to configure the wake up function.

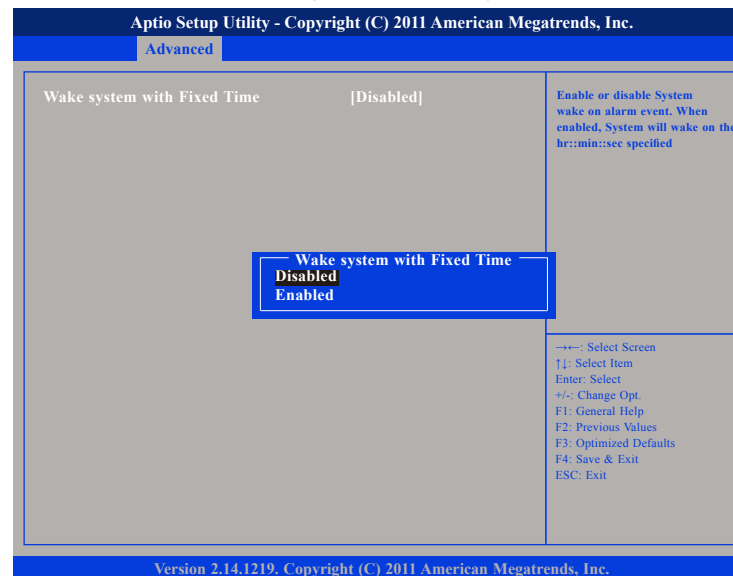

Enables or disables the system's wake on alarm event. When enabled, the system will wake up on the specified time.

CPU Configuration

This section is used to configure the CPU.



Aptio Setup Utility - Copyright (C) 2011 American Megatrends, Inc.

Advanced

CPU Configuration		Enabled for Windows XP and Linux (OS optimized for Hyper-Threading Technology) and Disabled for other OS (OS not optimized for Hyper-Threading Technology). When Disabled only one thread per enabled core is enabled.
Intel(R) Core(TM) CPU i5-3610ME CPU @ 2.70GHz		
CPU Signature	306a9	
Microcode Patch	10	
CPU Speed	1600 MHz	
Processor Cores	2	
Intel HT Technology	Supported	
Intel VT-x Technology	Supported	
Intel SMX Technology	Supported	
64-bit	Supported	
Hyper-threading	[Enabled]	
Limit CPUID Maximum	[Disabled]	
Intel Virtualization Technology	[Disabled]	

→←: Select Screen
↑↓: Select Item
Enter: Select
+/-: Change Opt.
F1: General Help
F2: Previous Values
F3: Optimized Defaults
F4: Save & Exit
ESC: Exit

Version 2.14.1219. Copyright (C) 2011 American Megatrends, Inc.

Hyper Threading

Enables or disables hyper-threading technology.

Limit CPUID Maximum

The CPUID instruction of some newer CPUs will return a value greater than 3. The default is Disabled because this problem does not exist in the Windows series operating systems. If you are using an operating system other than Windows, this problem may occur. To avoid this problem, enable this field to limit the return value to 3 or lesser than 3.

Intel® Virtualization Technology

Enables or disables Intel® Virtualization technology.

SATA Configuration

This section is used to configure the SATA drives.

Aptio Setup Utility - Copyright (C) 2011 American Megatrends, Inc.

Advanced

SATA Controller(s)	[Enabled]	Enable or disable SATA Device.
SATA Mode Selection	[IDE]	
Serial ATA Port 0	ST9160314AS (160.0)	
Software Preserve	SUPPORTED	
Serial ATA Port 1	Empty	
Software Preserve	Unknown	
Serial ATA Port 2	Empty	
Software Preserve	Unknown	
Serial ATA Port 3	32GB SATA Flas (32.0G)	
Software Preserve	SUPPORTED	

→←: Select Screen
 ↑↓: Select Item
 Enter: Select
 +/-: Change Opt.
 F1: General Help
 F2: Previous Values
 F3: Optimized Defaults
 F4: Save & Exit
 ESC: Exit

Version 2.14.1219. Copyright (C) 2011 American Megatrends, Inc.

SATA Controller(s)

Enables or disables SATA device.

SATA Mode Selection

Configures the SATA as IDE, AHCI or RAID mode.

- IDE This option configures the Serial ATA drives as Parallel ATA physical storage device.
- RAID This option allows you to create RAID or Intel Matrix Storage configuration on Serial ATA devices.
- AHCI This option configures the Serial ATA drives to use AHCI (Advanced Host Controller Interface). AHCI allows the storage driver to enable the advanced Serial ATA features which will increase storage performance.

Serial ATA Port 0 to Serial ATA Port 3

Displays information on the SATA devices detected.

USB Configuration

This section is used to configure the USB.



Legacy USB Support

Enable Enables Legacy USB.

Auto Disables support for Legacy when no USB devices are connected.

Disable Keeps USB devices available only for EFI applications.

USB3.0 Support

Enables or disables USB 3.0 controller support.

Super IO Configuration

This section is used to configure the serial ports.

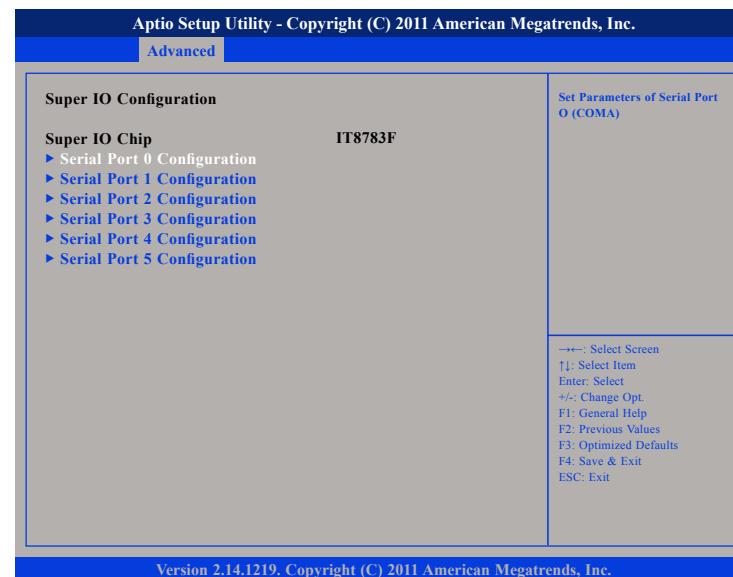

Super IO Chip

Displays the Super I/O chip used on the board.

Serial Port 0 Configuration

This section is used to configure serial port 0.

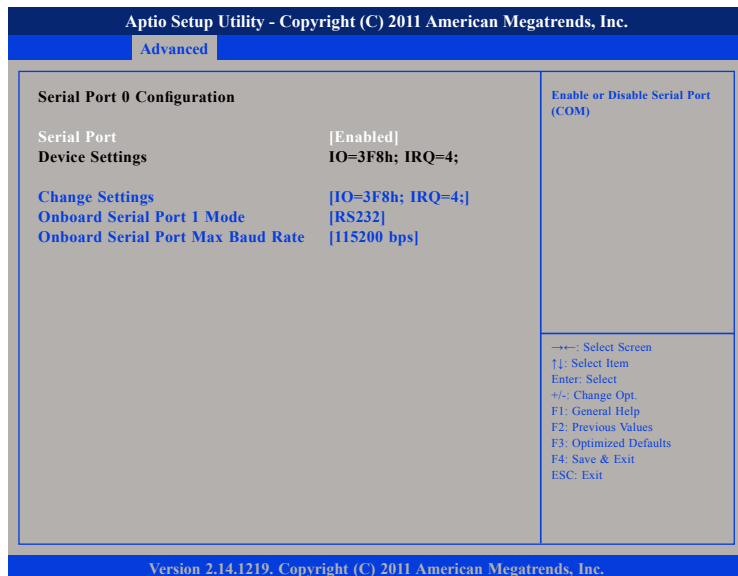

Serial Port

Enables or disables the serial port.

Change Settings

Selects an optimal setting for the Super IO device.

Onboard Serial Port 1 Mode

Select this to change the serial port mode to RS232, RS422, RS485 or RS485 Auto.

Onboard Serial Port Max Baud Rate

Select this to change the max baud rate of the serial port.

Serial Port 1 Configuration

This section is used to configure serial port 1.



Serial Port

Enables or disables the serial port.

Change Settings

Selects an optimal setting for the Super IO device.

Onboard Serial Port 1 Mode

Select this to change the serial port mode to RS232, RS422, RS485 or RS485 Auto.

Onboard Serial Port Max Baud Rate

Select this to change the max baud rate of the serial port.

Serial Port 2 Configuration

This section is used to configure serial port 2.



Serial Port

Enables or disables the serial port.

Change Settings

Selects an optimal setting for the Super IO device.

Onboard Serial Port Max Baud Rate

Select this to change the max baud rate of the serial port.

Serial Port 3 Configuration

This section is used to configure serial port 3.



Serial Port

Enables or disables the serial port.

Change Settings

Selects an optimal setting for the Super IO device.

Onboard Serial Port Max Baud Rate

Select this to change the max baud rate of the serial port.

Serial Port 4 Configuration

This section is used to configure serial port 4.



Serial Port

Enables or disables the serial port.

Change Settings

Selects an optimal setting for the Super IO device.

Onboard Serial Port Max Baud Rate

Select this to change the max baud rate of the serial port.

Serial Port 5 Configuration

This section is used to configure serial port 5.



Serial Port

Enables or disables the serial port.

Change Settings

Selects an optimal setting for the Super IO device.

Onboard Serial Port Max Baud Rate

Select this to change the max baud rate of the serial port.

Onboard Serial Port 6 Mode

Select this to change the serial port mode to RS232, RS422, RS485 or RS485 Auto.

Onboard Serial Port 6 Mode



Onboard Serial Port 6 Mode

Select this to change the serial port mode to RS232 or GPS.

Smart Fan Function

This section is used to configure the fan's function.

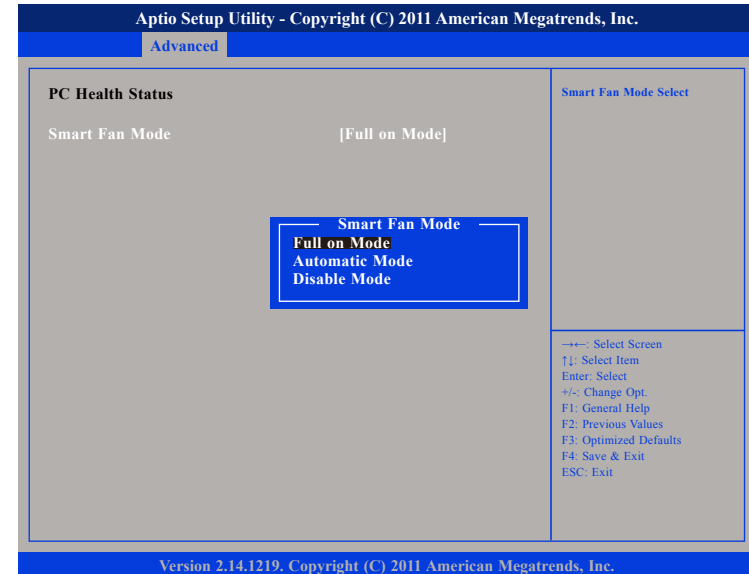

Smart Fan Mode

Selects the mode of the fan, the options are Full on Mode, Automatic Mode and Disable Mode.

H/W Monitor

This section is used to monitor hardware status such as temperature, fan speed and voltages.

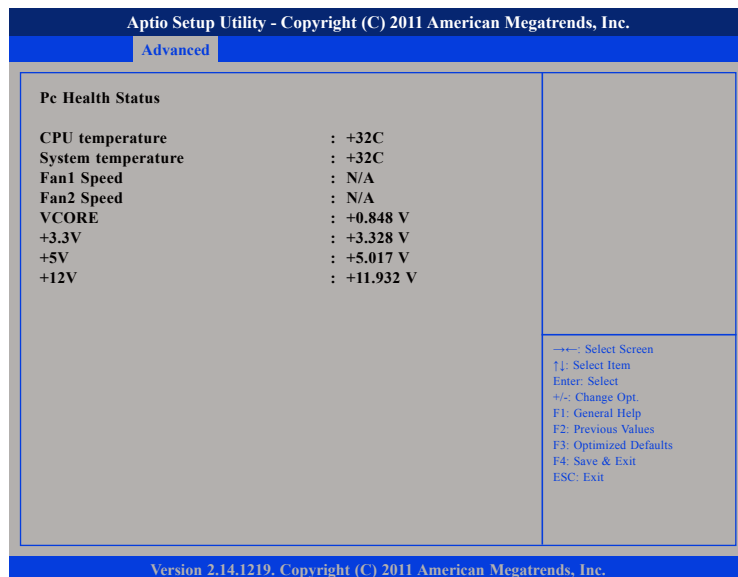

CPU Temperature

Detects and displays the current CPU temperature.

System Temperature

Detects and displays the current system temperature.

Fan1 Speed

Detects and displays Fan1 speed.

Fan2 Speed

Detects and displays Fan2 speed.

VCORE

Detects and displays the Vcore CPU voltage.

3.3V

Detects and displays 3.3V voltage.

5V

Detects and displays 5V voltage.

12V

Detects and displays 12V voltage.

CPU PPM Configuration

This section is used to configure the Processor Power Management (PPM) configuration.

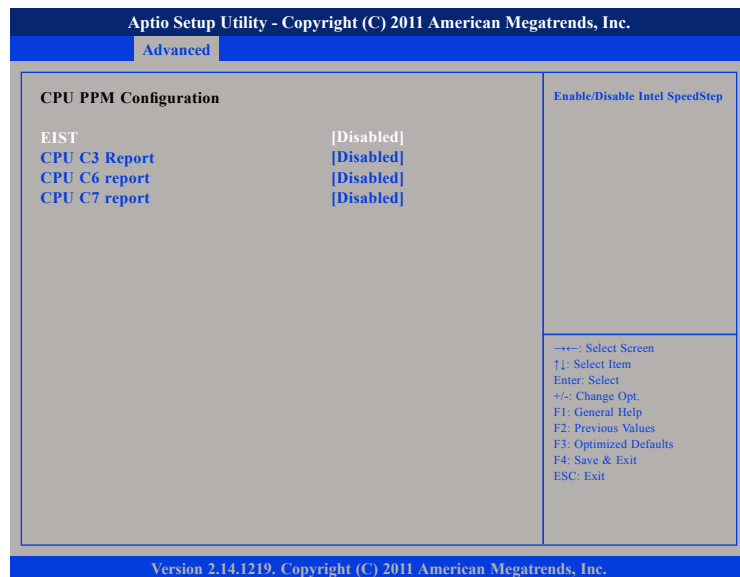

EIST

Enables or disables Intel® SpeedStep.

CPU C3 Report

Enables or disables C3 report to the operating system.

CPU C6 Report

Enables or disables C6 report to the operating system.

CPU C7 Report

Enables or disables C7 report to the operating system.

Chipset

This section gives you functions to configure the system based on the specific features of the chipset. The chipset manages bus speeds and access to system memory resources.



PCH-IO Configuration

PCH-IO parameters.

System Agent (SA) Configuration

System Agent (SA) parameters.

PCH-IO Configuration

This section is used to configure PCH-IO configuration.

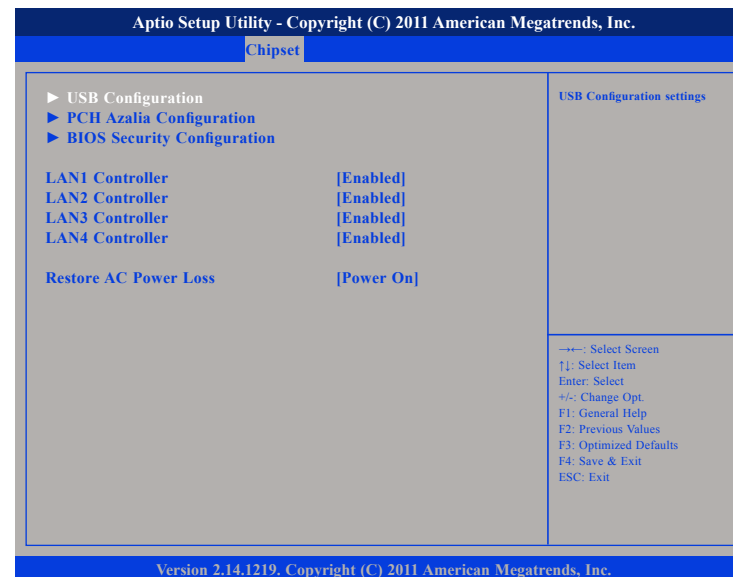

LAN1 to LAN4 Controller

Enables or disables the onboard controllers for LAN1 to LAN4.

USB Configuration



EHCI1 and EHCI2

Enables or disables the Enhanced Host Controller Interface (USB 2.0), one EHCI controller must always be enabled.

PCH Azalia Configuration



Azalia

Control Detection of the Azalia device.

Disabled Azalia will be unconditionally disabled.
 Enabled Azalia will be unconditionally Enabled.

BIOS Security Configuration



RTC RAM Lock

Enables or disables bytes 38h-3Fh in the upper and lower 128-byte bank of RTC RAM lockdown.

Restore AC Power Loss

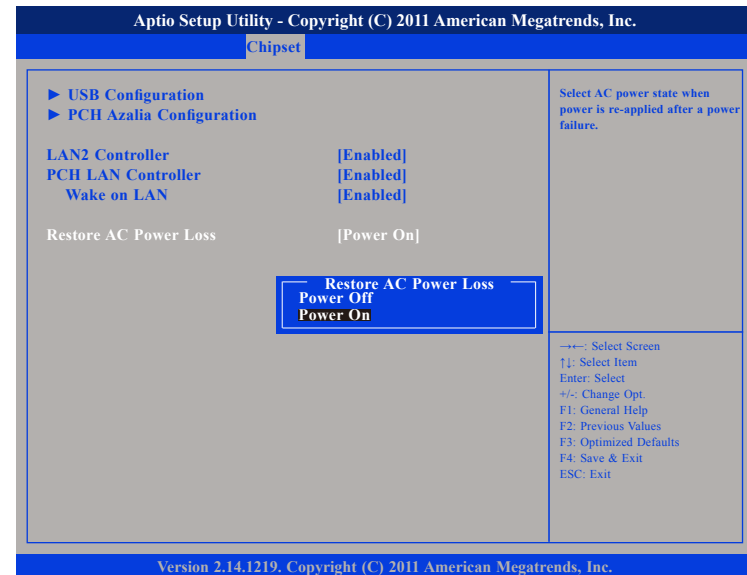

Restore AC Power Loss

- Off When power returns after an AC power failure, the system's power is off. You must press the Power button to power-on the system.
- On When power returns after an AC power failure, the system will automatically power-on.

System Agent (SA) Configuration

This section is used to configure the System Agent (SA) configuration.



VT-d

Enables or disables VT-d function on MCH.

Graphics Configuration

Configures the graphic chip settings.

NB PCIe Configuration

Configures the NB PCI Express settings.

Graphics Configuration



Primary Display

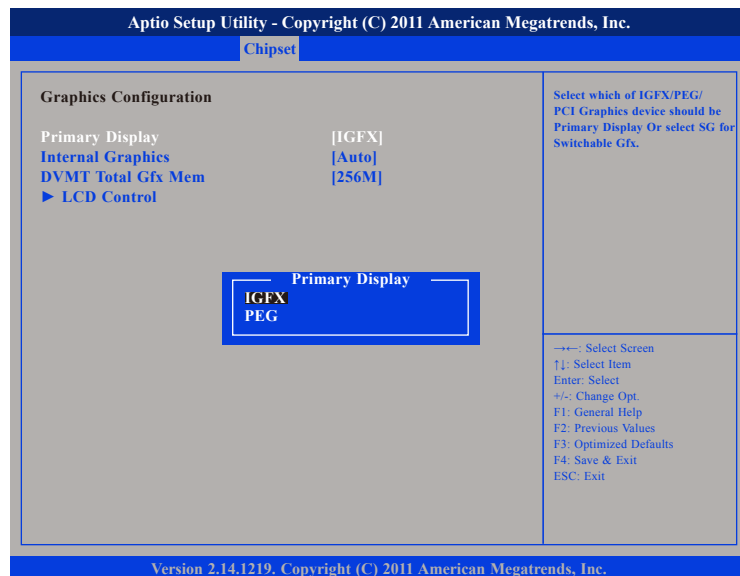

Select which of IGFX/PEG/PCI graphics device should be primary display or select SG for switchable Gfx.

Internal Graphics

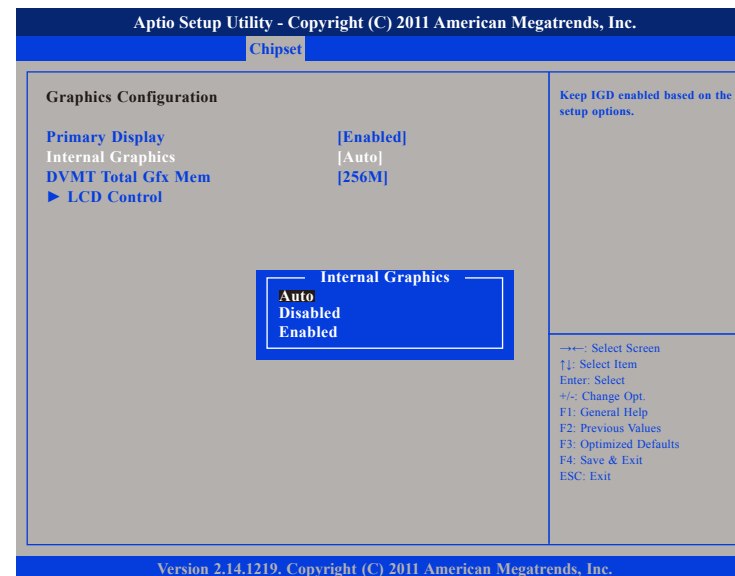

Keep IGD enabled based on the setup options.

Internal Graphics

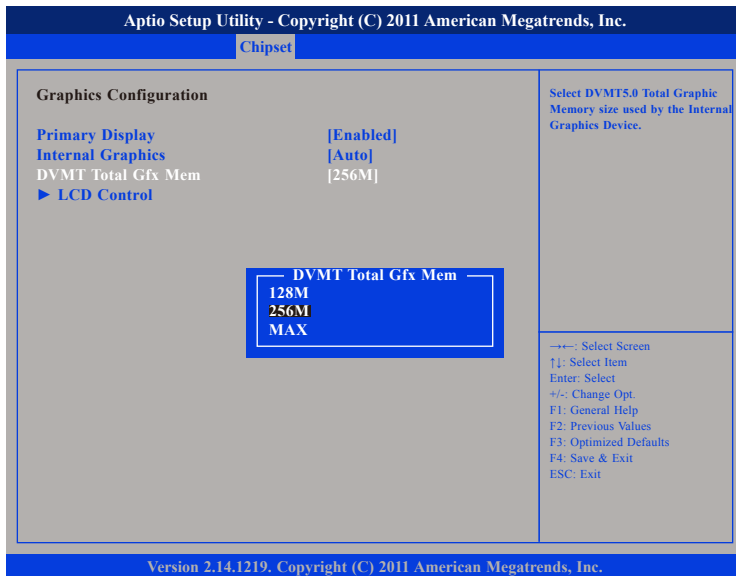

Selects DVT5.0 Total Graphic Memory size used by the Internal Graphics Device.

LCD Control

Aptio Setup Utility - Copyright (C) 2011 American Megatrends, Inc.

Chipset

LCD Control

Primary IGFX Boot Display [CRT]
 Secondary IGFX Boot Display [Disabled]
 LCD Panel Type [1024x768 LVDS]
 Active LFP [No LVDS]
 Panel Color Depth [18 Bit]

Select the Video Device which will be activated during POST. This has no effect if external graphics present. Secondary boot display selection will appear based on your selection. VGA modes will be supported only on primary display

←→: Select Screen
 ↑↓: Select Item
 Enter: Select
 +/-: Change Opt.
 F1: General Help
 F2: Previous Values
 F3: Optimized Defaults
 F4: Save & Exit
 ESC: Exit

Version 2.14.1219. Copyright (C) 2011 American Megatrends, Inc.

	DP	DP	Other ports	DP	DP	Other ports
Mode	Extended			Clone		
3-display	DP 1920 x 1080	DP 1920 x 1080	VGA 1920 x 1080	DP 1920 x 1080	DP 1920 x 1080	VGA 1920 x 1080
3-display	DP 1920 x 1080	DP 1920 x 1080	DVI 1920 x 1080	DP 1920 x 1080	DP 1920 x 1080	DVI 1920 x 1080
3-display	DP 1920 x 1080	DP 1920 x 1080	LVDS 1280 x 1024	DP 1920 x 1080	DP 1920 x 1080	LVDS 1280 x 1024

Primary IGFX Boot Display

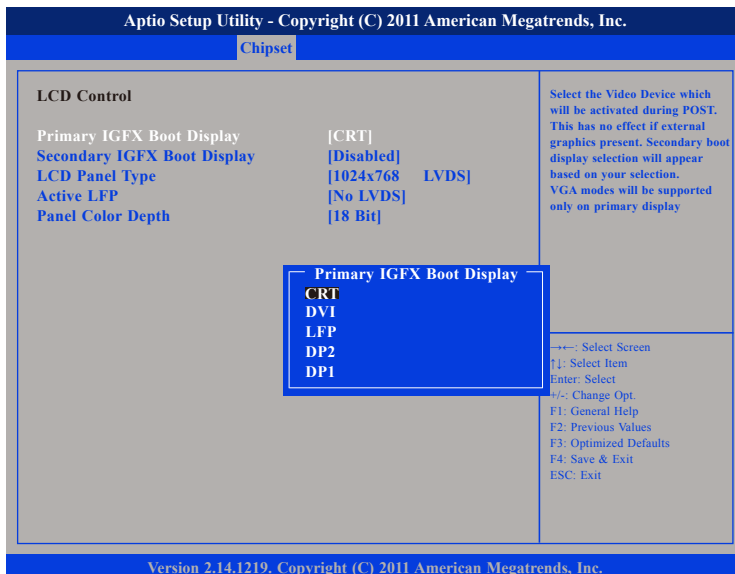

Select the video device which will be activated during POST. Has no effect if external graphics is present. Secondary boot display selection will appear based on your selection. VGA modes will be supported only on primary display.

Secondary IGFX Boot Display



Select the secondary display device.

LCD Panel Type

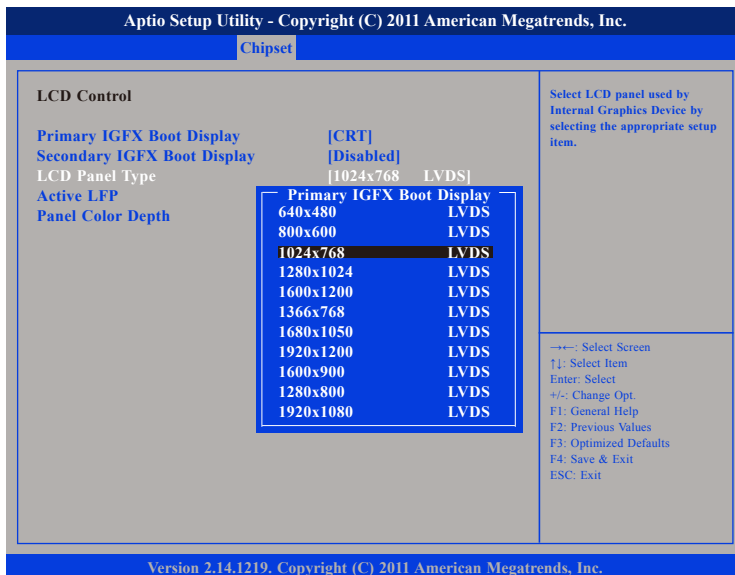

Select the LCD panel used by the internal graphics device by selecting the appropriate setup item.

Active LFP



Select the Active LFP configuration.

No LVDS
 Int-LVDS

VBIOS does not enable LVDS.
 VBIOS enables LVDS driver by Integrated encoder.

Panel Color Depth

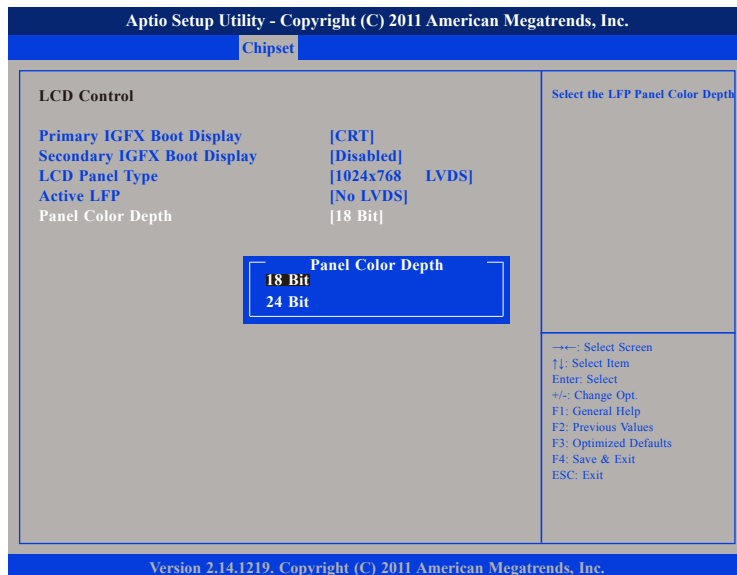

Select the LFP Panel Color Depth.

NB PCIe Configuration

This section is used to configure Northbridge PCI Express settings.

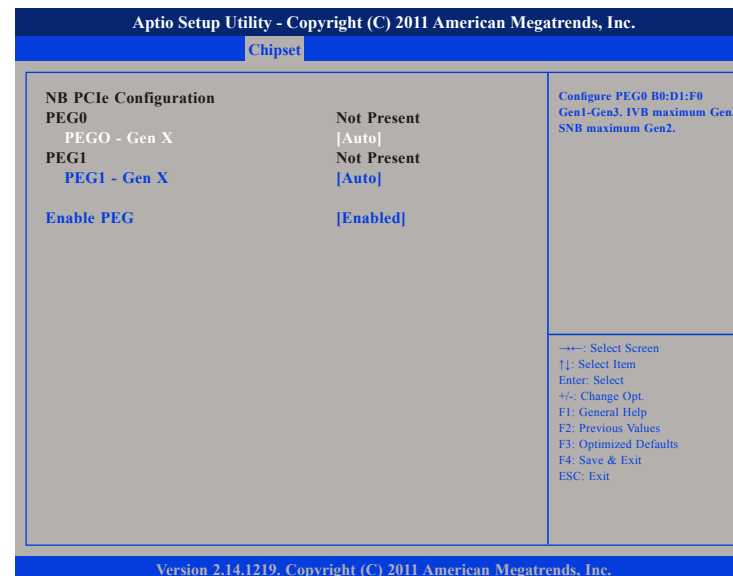

PEG0 - Gen X

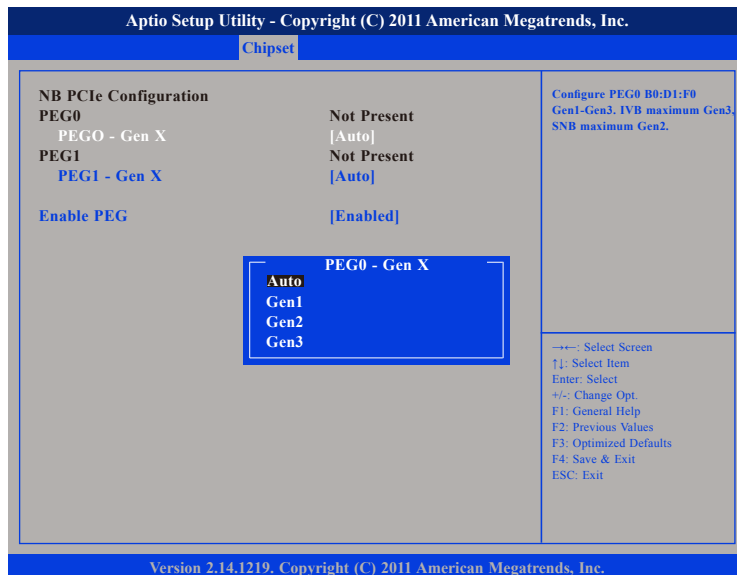

Configure PEG0 B0:D1:F0 Gen1-Gen3, IVB maximum Gen3, SNB maximum Gen2.

PEG1 - Gen X

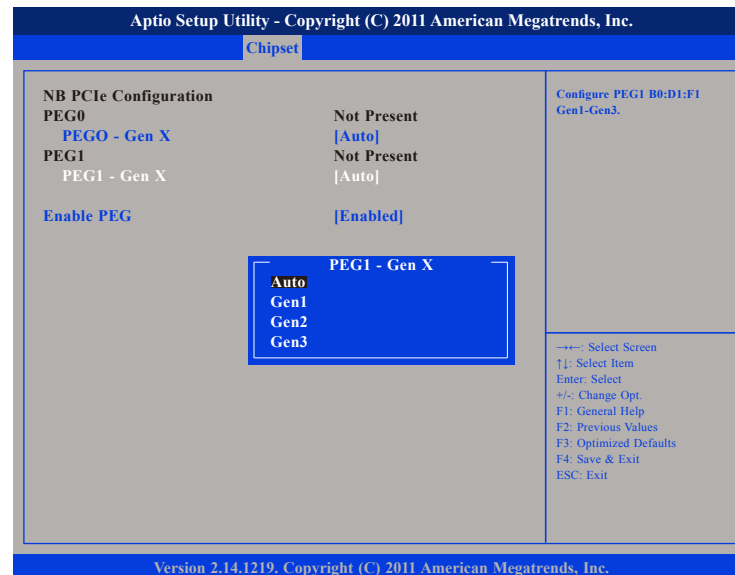

Configure PEG1 B0:D1:F1 Gen1-Gen3.

Enable PEG

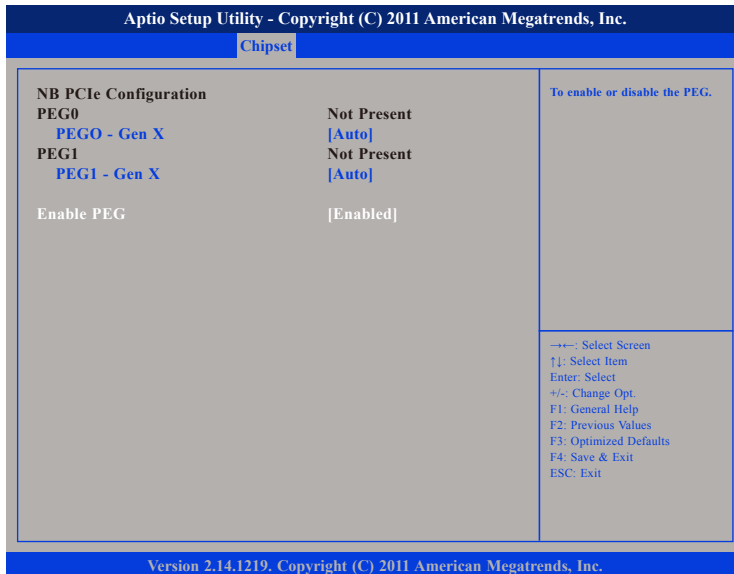

Enables or disables the PEG slot.

Boot

This section is used to configure the boot features.



Quiet Boot

Enabled Displays OEM logo instead of the POST messages.

Disabled Displays normal POST messages.

Launch PXE OpROM Policy

Controls the execution of UEFI and legacy PXE OpROM.

Boot Option Priorities

Adjust the boot sequence of the system. Boot Option #1 is the first boot device that the system will boot from, next will be #2 and so forth.

Boot Option #1



Sets the system boot order.

Hard Drive BBS Priorities

Boot Option #1

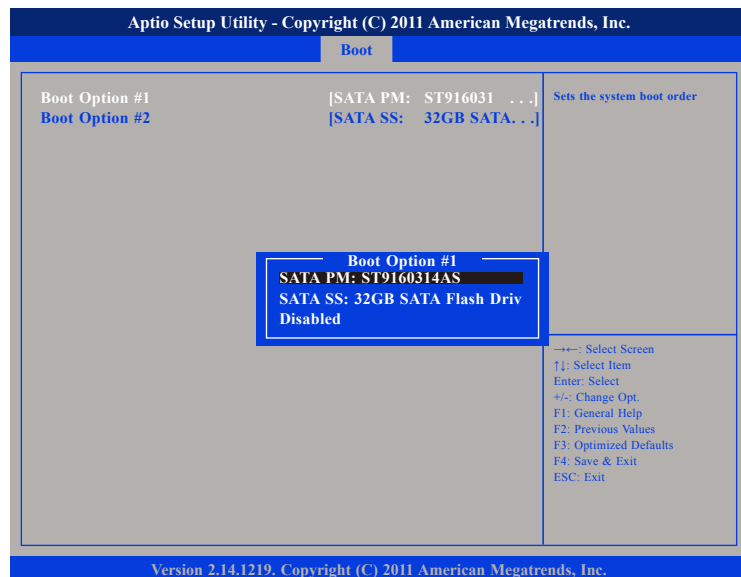

Sets the first legacy device to boot from.

Boot Option #2

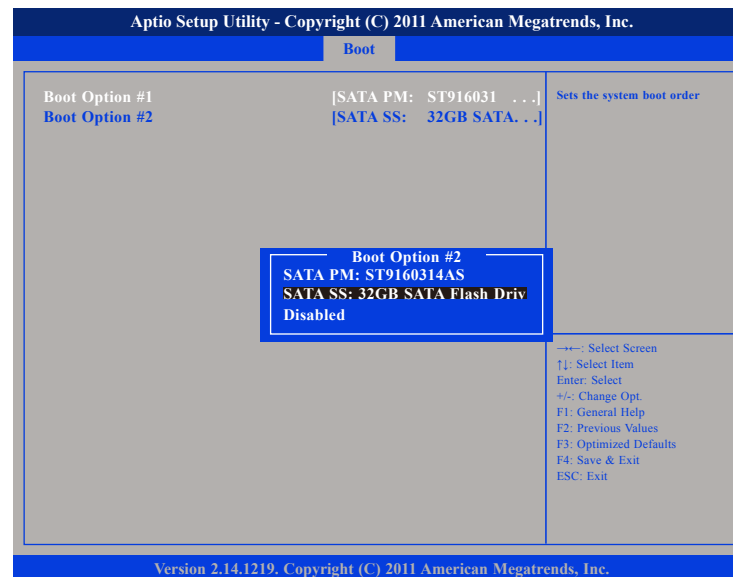

Sets the second legacy device to boot from.

Security

Aptio Setup Utility - Copyright (C) 2011 American Megatrends, Inc.					
Main	Advanced	Chipset	Boot	Security	Save & Exit
<p>Password Description</p> <p>If ONLY the Administrator's password is set, then this only limits access to Setup and is only asked for when entering Setup. If ONLY the User's password is set, then this is a power on password and must be entered to boot or enter Setup. In Setup the User Will have Administrator rights. The password length must be in the following range:</p> <table border="0"> <tr> <td>Minimum length</td> <td>3</td> </tr> <tr> <td>Maximum</td> <td>20</td> </tr> </table> <p>Administrator Password User Password</p>		Minimum length	3	Maximum	20
Minimum length	3				
Maximum	20				
<p>Set Administrator Password</p>					
<p>→←: Select Screen ↑↓: Select Item Enter: Select +/-: Change Opt. F1: General Help F2: Previous Values F3: Optimized Defaults F4: Save & Exit ESC: Exit</p>					
Version 2.14.1219. Copyright (C) 2011 American Megatrends, Inc.					

Administrator Password

Select this to reconfigure the administrator's password.

User Password

Select this to reconfigure the user's password.

Save & Exit

Aptio Setup Utility - Copyright (C) 2011 American Megatrends, Inc.					
Main	Advanced	Chipset	Boot	Security	Save & Exit
<p>Save Changes and Reset Discard Changes and Reset</p> <p>Load Optimized Defaults</p>					
<p>Reset the system after saving the changes.</p>					
<p>→←: Select Screen ↑↓: Select Item Enter: Select +/-: Change Opt. F1: General Help F2: Previous Values F3: Optimized Defaults F4: Save & Exit ESC: Exit</p>					
Version 2.14.1219. Copyright (C) 2011 American Megatrends, Inc.					

Save Changes and Reset

To save the changes and reset, select this field then press <Enter>. A dialog box will appear. Confirm by selecting Yes.

Discard Changes and Reset

To exit the Setup utility without saving the changes, select this field then press <Enter>. You may be prompted to confirm again before exiting.

Load Optimized Defaults

To restore the BIOS to default settings, select this field then press <Enter>. A dialog box will appear. Confirm by selecting Yes.

Appendix A: Power Consumption

Test Configuration

System Configuration	Sys#1
Chassis	CHASSIS NISE3600 VER:A
CPU	Intel® Core™ i7-3517UE Processor (4M Cache, up to 2.80 GHz)
Memory	Transcend 4GB DDR3 1600MHz SODIMM (TS512MSK64V6N) x2
CPU board	N/A
Mother board	NISB3640 REV:A
HDD	HDD 2.5" SATA Automotive HITACHI:HEJ421080G9SA00 (-30° to 85° C)
FDD	N/A
CD-ROM	N/A
CFast	Apacer CFast 32GB
Power Supply	POWER ADAPTER FSP120-ACB 120W 24V/5A w/PSE MARK
Add-on Card	N/A
CPU Cooler	NISE3640 CPU HEATSINK SHYUNG SHUHN
System FAN	N/A
Keyboard	Microsoft Wired Keyboard 600
Mouse	Microsoft Basic Optical Mouse
Monitor	ASUS VS228

Power Consumption Management

Purpose

The purpose of the power consumption test is to verify the power dissipation of system, and the loading of power supply.

Test Equipment

PROVA CM-07 AC/DC CLAMP METER

Device Under Test

DUT: sys#1/

Test Procedure

1. Power up the DUT, boot into Windows 7 x64 Ultimate
2. Entering standby mode (HDD power down)
3. Measure the power consumption and record it.
4. Run Burn-in test program to apply 100% full loading
5. Measure the power consumption and record it.

Test Data

	Sys #1 (Disabled Turbo Boot)
	+24V
Full-Loading Mode	1.61A
Total	38.64W
Standby S3Mode	0.08A
Total	1.92W

Appendix B: GPIO Programming Guide

GPIO (General Purpose Input/Output) pins are provided for custom system design. This appendix provides definitions and its default setting for the ten GPIO pins. The pin definition is shown in the following table:

Pin	GPIO mode	PowerOn Default	Address	Pin	GPIO mode	PowerOn Default	Address
1	VCC	-	-	2	GND	-	-
3	GPO0	Low	A04h (Bit4)	4	GPIO	High	A04h (Bit0)
5	GPO1	Low	A04h (Bit5)	6	GP11	High	A04h (Bit1)
7	GPO2	Low	A04h (Bit6)	8	GP12	High	A04h (Bit2)
9	GPO3	Low	A04h (Bit7)	10	GP13	High	A04h (Bit3)

Control the GPO pin (3/5/7/9) level from I/O port A04h bit (4/5/6/7).
The bit is Set/Clear indicated output High/Low.

GPIO programming sample code

```
#define GPIO_PORT      0xA04
#define GPO0          (0x01 << 4)
#define GPO1          (0x01 << 5)
#define GPO2          (0x01 << 6)
#define GPO3          (0x01 << 7)

#define GPO0_HI       outputb(GPIO_PORT, GPO0)
#define GPO0_LO       outputb(GPIO_PORT, 0x00)
#define GPO1_HI       outputb(GPIO_PORT, GPO1)
#define GPO1_LO       outputb(GPIO_PORT, 0x00)
#define GPO2_HI       outputb(GPIO_PORT, GPO2)
#define GPO2_LO       outputb(GPIO_PORT, 0x00)
#define GPO3_HI       outputb(GPIO_PORT, GPO3)
#define GPO3_LO       outputb(GPIO_PORT, 0x00)
void main(void)
{
    GPO0_HI;
    GPO1_LO;
    GPO2_HI;
    GPO3_LO;
}
```

Appendix C: Watchdog Timer Setting

ITE8783 WatchDog Programming Guide

```
#define SUPERIO_PORT    0x2E
#define WDT_SET        0x72
#define WDT_VALUE      0x73

void main(void)
{
    #Enter SuperIO Configuration
    outputb(SUPERIO_PORT, 0x87);
    outputb(SUPERIO_PORT, 0x01);
    outputb(SUPERIO_PORT, 0x55);
    outputb(SUPERIO_PORT, 0x55);

    # Set LDN
    outputb(SUPERIO_PORT, 0x07);
    outputb(SUPERIO_PORT+1 ,0x07);

    # Set WDT setting
    outputb(SUPERIO_PORT, WDT_SET);           #Use the second
    outputb(SUPERIO_PORT+1, 0xC0);           #Use the minute, change value to 0x40

    # Set WDT sec/min
    outputb(SUPERIO_PORT, WDT_VALUE);
    outputb(SUPERIO_PORT+1, 0x05);           #Set 5 seconds
}
```