



NEXCOM International Co., Ltd.

## **Industrial Computing Solutions**

# **Embedded Computing (Industrial Motherboard)**

## **NEX 981**

### User Manual

# Contents

## Preface

Copyright .....	iv
Disclaimer .....	iv
Acknowledgements .....	iv
Regulatory Compliance Statements .....	iv
Declaration of Conformity .....	iv
RoHS Compliance .....	v
Warranty and RMA .....	vi
Safety Information .....	viii
Installation Recommendations .....	viii
Safety Precautions .....	ix
Technical Support and Assistance .....	x
Conventions Used in this Manual .....	x
Global Service Contact Information .....	xi
Package Contents .....	xiii
Ordering Information .....	xiv

## Chapter 1: Product Introduction

Overview .....	1
Key Features .....	1
Hardware Specifications .....	2
Knowing Your NEX 981 .....	4
Edge I/O View .....	5

## Chapter 2: Jumpers and Connectors

Before You Begin .....	6
Precautions .....	6
Jumper Settings .....	7
Locations of the Jumpers and Connectors .....	8
Jumpers .....	9
CMOS Clear Select .....	9
ATX/AT Mode Jumper .....	9
Digital Input/Output Power Select .....	10
Connector Pin Definitions .....	11
Internal Connectors .....	11
3-Pin CPU Fan Connector (+12V) .....	11
RS-232 Port 4 Pin Headers .....	11
System Panel Header .....	12
4-Pin Chassis Fan Connector (+12V) .....	12
Digital Input/Output Pin Headers .....	13
USB2.0 Connectors .....	13
Printer Port Header .....	14
Front Panel Audio Header .....	14
Chassis Intrusion Pin Headers .....	15
Block Diagram .....	16

## Chapter 3: BIOS Setup

About BIOS Setup .....	17
When to Configure the BIOS .....	17



Default Configuration .....	18
Entering Setup .....	18
Legends .....	18
BIOS Setup Utility .....	20
Main .....	20
Advanced .....	21
H/W Monitor .....	30
Boot .....	31
Security .....	32
Exit .....	33



# Preface

## Copyright

This publication, including all photographs, illustrations and software, is protected under international copyright laws, with all rights reserved. No part of this manual may be reproduced, copied, translated or transmitted in any form or by any means without the prior written consent from NEXCOM International Co., Ltd.

## Disclaimer

The information in this document is subject to change without prior notice and does not represent commitment from NEXCOM International Co., Ltd. However, users may update their knowledge of any product in use by constantly checking its manual posted on our website: <http://www.nexcom.com>. NEXCOM shall not be liable for direct, indirect, special, incidental, or consequential damages arising out of the use of any product, nor for any infringements upon the rights of third parties, which may result from such use. Any implied warranties of merchantability or fitness for any particular purpose is also disclaimed.

## Acknowledgements

NEX 981 is a trademark of NEXCOM International Co., Ltd. All other product names mentioned herein are registered trademarks of their respective owners.

## Regulatory Compliance Statements

This section provides the FCC compliance statement for Class B devices and describes how to keep the system CE compliant.

## Declaration of Conformity

### FCC

This equipment has been tested and verified to comply with the limits for a Class B digital device, pursuant to Part 15 of FCC Rules. These limits are designed to provide reasonable protection against harmful interference when the equipment is operated in a commercial environment. This equipment generates, uses, and can radiate radio frequency energy and, if not installed and used in accordance with the instructions, may cause harmful interference to radio communications. Operation of this equipment in a residential area (domestic environment) is likely to cause harmful interference, in which case the user will be required to correct the interference (take adequate measures) at their own expense.

### CE

The product(s) described in this manual complies with all applicable European Union (CE) directives if it has a CE marking. For computer systems to remain CE compliant, only CE-compliant parts may be used. Maintaining CE compliance also requires proper cable and cabling techniques.

## RoHS Compliance



### **NEXCOM RoHS Environmental Policy and Status Update**

This publication, including all photographs, illustrations and software, is protected under international copyright laws, with all rights reserved. No part of this manual may be reproduced, copied, translated or transmitted in any form or by any means without the prior written consent from NEXCOM International Co., Ltd.

RoHS restricts the use of Lead (Pb) < 0.1% or 1,000ppm, Mercury (Hg) < 0.1% or 1,000ppm, Cadmium (Cd) < 0.01% or 100ppm, Hexavalent Chromium (Cr6+) < 0.1% or 1,000ppm, Polybrominated biphenyls (PBB) < 0.1% or 1,000ppm, and Polybrominated diphenyl Ethers (PBDE) < 0.1% or 1,000ppm.

In order to meet the RoHS compliant directives, NEXCOM has established an engineering and manufacturing task force to implement the introduction of green products. The task force will ensure that we follow the standard NEXCOM development procedure and that all the new RoHS components and new manufacturing processes maintain the highest industry quality levels for which NEXCOM are renowned.

The model selection criteria will be based on market demand. Vendors and suppliers will ensure that all designed components will be RoHS compliant.

### **How to recognize NEXCOM RoHS Products?**

For existing products where there are non-RoHS and RoHS versions, the suffix "(LF)" will be added to the compliant product name.

All new product models launched after January 2006 will be RoHS compliant. They will use the usual NEXCOM naming convention.

## Warranty and RMA

### NEXCOM Warranty Period

NEXCOM manufactures products that are new or equivalent to new in accordance with industry standard. NEXCOM warrants that products will be free from defect in material and workmanship for 2 years, beginning on the date of invoice by NEXCOM. HCP series products (Blade Server) which are manufactured by NEXCOM are covered by a three year warranty period.

### NEXCOM Return Merchandise Authorization (RMA)

- Customers shall enclose the “NEXCOM RMA Service Form” with the returned packages.
- Customers must collect all the information about the problems encountered and note anything abnormal or, print out any on-screen messages, and describe the problems on the “NEXCOM RMA Service Form” for the RMA number apply process.
- Customers can send back the faulty products with or without accessories (manuals, cable, etc.) and any components from the card, such as CPU and RAM. If the components were suspected as part of the problems, please note clearly which components are included. Otherwise, NEXCOM is not responsible for the devices/parts.
- Customers are responsible for the safe packaging of defective products, making sure it is durable enough to be resistant against further damage and deterioration during transportation. In case of damages occurred during transportation, the repair is treated as “Out of Warranty.”
- Any products returned by NEXCOM to other locations besides the customers’ site will bear an extra charge and will be billed to the customer.

### Repair Service Charges for Out-of-Warranty Products

NEXCOM will charge for out-of-warranty products in two categories, one is basic diagnostic fee and another is component (product) fee.

### Repair Service Charges for Out-of-Warranty Products

NEXCOM will charge for out-of-warranty products in two categories, one is basic diagnostic fee and another is component (product) fee.

### System Level

- Component fee: NEXCOM will only charge for main components such as SMD chip, BGA chip, etc. Passive components will be repaired for free, ex: resistor, capacitor.
- Items will be replaced with NEXCOM products if the original one cannot be repaired. Ex: motherboard, power supply, etc.
- Replace with 3rd party products if needed.
- If RMA goods can not be repaired, NEXCOM will return it to the customer without any charge.

### Board Level

- Component fee: NEXCOM will only charge for main components, such as SMD chip, BGA chip, etc. Passive components will be repaired for free, ex: resistors, capacitors.
- If RMA goods can not be repaired, NEXCOM will return it to the customer without any charge.

## Warnings

Read and adhere to all warnings, cautions, and notices in this guide and the documentation supplied with the chassis, power supply, and accessory modules. If the instructions for the chassis and power supply are inconsistent with these instructions or the instructions for accessory modules, contact the supplier to find out how you can ensure that your computer meets safety and regulatory requirements.

## Cautions

Electrostatic discharge (ESD) can damage system components. Do the described procedures only at an ESD workstation. If no such station is available, you can provide some ESD protection by wearing an antistatic wrist strap and attaching it to a metal part of the computer chassis.

## Safety Information

Before installing and using the device, note the following precautions:

- Read all instructions carefully.
- Do not place the unit on an unstable surface, cart, or stand.
- Follow all warnings and cautions in this manual.
- When replacing parts, ensure that your service technician uses parts specified by the manufacturer.
- Avoid using the system near water, in direct sunlight, or near a heating device.
- The load of the system unit does not solely rely for support from the rackmounts located on the sides. Firm support from the bottom is highly necessary in order to provide balance stability.
- The computer is provided with a battery-powered real-time clock circuit. There is a danger of explosion if battery is incorrectly replaced. Replace only with the same or equivalent type recommended by the manufacturer. Discard used batteries according to the manufacturer's instructions.

## Installation Recommendations

Ensure you have a stable, clean working environment. Dust and dirt can get into components and cause a malfunction. Use containers to keep small components separated.

Adequate lighting and proper tools can prevent you from accidentally damaging the internal components. Most of the procedures that follow require only a few simple tools, including the following:

- A Philips screwdriver
- A flat-tipped screwdriver
- A grounding strap
- An anti-static pad

Using your fingers can disconnect most of the connections. It is recommended that you do not use needle-nose pliers to disconnect connections as these can damage the soft metal or plastic parts of the connectors.



## Safety Precautions

1. Read these safety instructions carefully.
2. Keep this User Manual for later reference.
3. Disconnect this equipment from any AC outlet before cleaning. Use a damp cloth. Do not use liquid or spray detergents for cleaning.
4. For plug-in equipment, the power outlet socket must be located near the equipment and must be easily accessible.
5. Keep this equipment away from humidity.
6. Put this equipment on a stable surface during installation. Dropping it or letting it fall may cause damage.
7. The openings on the enclosure are for air convection to protect the equipment from overheating. **DO NOT COVER THE OPENINGS.**
8. Make sure the voltage of the power source is correct before connecting the equipment to the power outlet.
9. Place the power cord in a way so that people will not step on it. Do not place anything on top of the power cord. Use a power cord that has been approved for use with the product and that it matches the voltage and current marked on the product's electrical range label. The voltage and current rating of the cord must be greater than the voltage and current rating marked on the product.
10. All cautions and warnings on the equipment should be noted.
11. If the equipment is not used for a long time, disconnect it from the power source to avoid damage by transient overvoltage.
12. Never pour any liquid into an opening. This may cause fire or electrical shock.
13. Never open the equipment. For safety reasons, the equipment should be opened only by qualified service personnel.
14. If one of the following situations arises, get the equipment checked by service personnel:
  - a. The power cord or plug is damaged.
  - b. Liquid has penetrated into the equipment.
  - c. The equipment has been exposed to moisture.
  - d. The equipment does not work well, or you cannot get it to work according to the user's manual.
  - e. The equipment has been dropped and damaged.
  - f. The equipment has obvious signs of breakage.
15. Do not place heavy objects on the equipment.
16. The unit uses a three-wire ground cable which is equipped with a third pin to ground the unit and prevent electric shock. Do not defeat the purpose of this pin. If your outlet does not support this kind of plug, contact your electrician to replace your obsolete outlet.
17. **CAUTION: DANGER OF EXPLOSION IF BATTERY IS INCORRECTLY REPLACED. REPLACE ONLY WITH THE SAME OR EQUIVALENT TYPE RECOMMENDED BY THE MANUFACTURER. DISCARD USED BATTERIES ACCORDING TO THE MANUFACTURER'S INSTRUCTIONS.**

## Technical Support and Assistance

1. For the most updated information of NEXCOM products, visit NEXCOM's website at [www.nexcom.com](http://www.nexcom.com).
2. For technical issues that require contacting our technical support team or sales representative, please have the following information ready before calling:
  - Product name and serial number
  - Detailed information of the peripheral devices
  - Detailed information of the installed software (operating system, version, application software, etc.)
  - A complete description of the problem
  - The exact wordings of the error messages

### Warning!

1. Handling the unit: carry the unit with both hands and handle it with care.
2. Maintenance: to keep the unit clean, use only approved cleaning products or clean with a dry cloth.
3. CompactFlash: Turn off the unit's power before inserting or removing a CompactFlash storage card.

## Conventions Used in this Manual



### Warning:

Information about certain situations, which if not observed, can cause personal injury. This will prevent injury to yourself when performing a task.



### Caution:

Information to avoid damaging components or losing data.



### Note:

Provides additional information to complete a task easily.

## Global Service Contact Information

### Headquarters

#### **NEXCOM International Co., Ltd.**

15F, No. 920, Chung-Cheng Rd.,  
ZhongHe District, New Taipei City, 23586,  
Taiwan, R.O.C.

Tel: +886-2-8226-7786

Fax: +886-2-8226-7782

www.nexcom.com

### America

#### **USA**

#### **NEXCOM USA**

2883 Bayview Drive, Fremont CA 94538,  
USA

Tel: +1-510-656-2248

Fax: +1-510-656-2158

Email: sales@nexcom.com

www.nexcom.com

### Asia

#### **Taiwan**

#### **Central Taiwan Office**

16F, No.250, Sec. 2, Chongde Rd.,  
Beitun Dist., Taichung City 406, R.O.C.

Tel: +886-4-2249-1179

Fax: +886-4-2249-1172

Email: sales@nexcom.com.tw

www.nexcom.com.tw

#### **Japan**

#### **NEXCOM Japan**

9F, Tamachi Hara Bldg.,4-11-5, Shiba Minato-ku,  
Tokyo, 108-0014, Japan

Tel: +81-3-5419-7830

Fax: +81-3-5419-7832

Email: sales@nexcom-jp.com

www.nexcom-jp.com

#### **China**

#### **NEXCOM China**

2F, Block 4, Venus Plaza, Bldg. 21,  
ZhongGuanCun Software Park, No. 8,  
Dongbeiwang West Rd., Haidian District,  
Beijing, 100193, China

Tel: +86-10-8282-5880

Fax: +86-10-8282-5955

Email: sales@nexcom.cn

www.nexcom.cn

#### **Shanghai Office**

Room 1505, Greenland He Chuang Bldg.,  
No. 450 Caoyang Rd.,  
Shanghai, 200062, China

Tel: +86-21-6150-8008

Fax: +86-21-3251-6358

Email: sales@nexcom.cn

www.nexcom.cn

#### **Nanjing Office**

Hall C, Block 17, Tian Xing Cui Lang Bldg.,  
No. 49 Yunnan North Rd.,  
Nanjing, 210018, China

Tel: +86-25-8315-3486

Fax: +86-25-8315-3489

Email: sales@nexcom.cn

www.nexcom.cn

#### **Shenzhen Office**

Western Room 708, Block 210,  
Tairan Industry & Trading Place,  
Futian Area, Shenzhen,  
518040, China

Tel: +86-755-8332-7203

Fax: +86-755-8332-7213

Email: sales@nexcom.cn

www.nexcom.cn

#### **Wuhan Office**

1-C 1804/ 1805, Mingze Liwan,  
No. 519 South Luoshi Rd.,  
Hongshan District,  
Wuhan, 430070, China

Tel: +86-27-8722-7400

Fax: +86-27-8722-7400

Email: sales@nexcom.cn

www.nexcom.cn

## Chengdu Office

9F, Shuxiangxie, Xuefu Garden,  
No.12 Section 1, South Yihuan Rd.,  
Chengdu, 610061, China  
Tel: +86-28-8523-0186  
Fax: +86-28-8523-0186  
Email: sales@nexcom.cn  
www.nexcom.cn

## Europe

### France

#### NEXCOM France

La Grande Arche-Paroi Nord,  
92044 Paris La Défense, France  
Tel: +33 (0) 1 40 90 33 35  
Fax: +33 (0) 1 40 90 31 01  
Email: sales.fr@nexcom.eu  
www.nexcom.eu

### Germany

NEXCOM GmbH  
Leopoldstraße Business Centre,  
Leopoldstraße 244,  
80807 Munich, Germany  
Tel: +49-89-208039-278  
Fax: +49-89-208039-279  
Email: sales.de@nexcom.eu  
www.nexcom.eu

## Italy

NEXCOM ITALIA S.r.l  
Via Gaudenzio Ferrari 29,  
21047 Saronno (VA), Italia  
Tel: +39 02 9628 0333  
Fax: +39 02 9286 9215  
Email: nexcomitalia@nexcom.eu  
www.nexcomitalia.it

## United Kingdom

### NEXCOM EUROPE

10 Vincent Avenue,  
Crownhill Business Centre,  
Milton Keynes, Buckinghamshire MK8 0AB,  
United Kingdom  
Tel: +44-1908-267121  
Fax: +44-1908-262042  
Email: sales.uk@nexcom.eu  
www.nexcom.eu

## Package Contents

Before continuing, verify that the NEX 981 package that you received is complete. Your package should have all the items listed in the following table.

Item	Part Number	Name	Description	Qty
1	20G00098100X0	ASSY NEX981-DB		1
2	601111A238X00	NEX 980 Outside Carton FULPAK	700x430x331mm	10
3	60177A0321X00	(N)NEX981 Quick Reference Guide VER:A	KRAMER	1
4	602DCD0700X00	(N)NEX981 DVD Driver VER:1.0		1
5	6012200052X00	PE Zipper Bag #8	170x240mm, w/China RoHS Symbol	1

## Ordering Information

The following information below provides ordering information for NEX 981.

### **NEX 981-10PBK (P/N: 10G00098100X0)**

Bulk-Packed 10x pcs ATX, LGA1150 of 4th Generation Intel® Core™ i7/i5/i3/ Pentium®/ Celeron® processors, Q87 with 4x DDR3/ DIMM, HDMI/ DP/ VGA, PCIe x16/ PCIe x4/ PCIe x1/ 4PCI/ 5x SATA3.0, 4x USB 3.0/ 8x USB 2.0, 2x GbE, 6x COM, mSATA, and ATX Power Input.

# Chapter 1: Product Introduction

## Overview

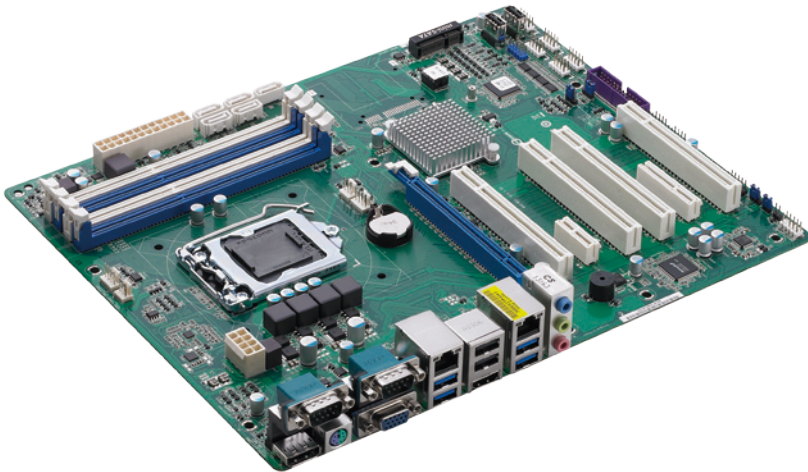

## Key Features

- Support Socket LGA 1150 for 4th Generation Intel® Core™ i7/i5/i3/ Pentium®/ Celeron® Processors
- 4x DDR3 DIMM Socket up to 32 GB
- Support DisplayPort/ HDMI/ VGA dual display
- 2x Intel® GbE, 5x SATA3.0, mSATA, 12x USB3.0/ 2.0, 6x COM, 8x GPIO
- 1x PCIe x16 (Gen. 3.0), 1x PCIe x4, 1x PCIe x1, 4x PCI (v2.3)
- Support AT/ ATX mode by ATX Power Input

## Hardware Specifications

### CPU Support

- Socket LGA1150, 4th generation Intel® Core™ i7/i5/i3/ Pentium®/ Celeron® processors

### Main Memory

- 4x 240-pin dual channel long DIMMs support DDR3 1066/ 1333/ 1600MHz up to 32GB system memory

### Chipset

- Intel® Q87 Platform Controller Hub

### BIOS

- AMI BIOS UEFI
- Plug and play support

### On-board LAN

- 1x Intel® I217LM PHY for AMT 9.0
- 1x Intel® I210 PCI Express Gigabit Ethernet
- Support boot from LAN (PXE)
- 2x RJ45 with LEDs

### Display

- 4th generation Intel® Core™ socket LGA1150 processors Integrated HD graphics
- 1x HDMI
- 1x DisplayPort
- 1x VGA

### Expansion

- 1x PCIe x16 (Gen. 3.0)
- 1x PCIe x4
- 1x PCIe x1
- 4x PCI (v2.3)

### Edge I/O Interfaces

- 1x Combo for PS2 KB/ MS
- 2x stack DB9 for COM1 & COM2
- 1x DisplayPort
- 1x HDMI with dual stack USB 2.0 (black)
- 1x VGA
- 2x RJ45 with dual stack USB 3.0 (blue) connectors
- Line-In/ Line-Out/ MIC phone jack

### I/O Interfaces

- Serial port : 6 ports
- COM1/2 : RS232/422/485 with DB9 male connector on edge I/O
- COM3/4/5/6 : RS232 2x5/ 2.54mm box header
- USB 2.0/ 3.0 : 12 ports
- 4x USB 3.0 ports by edge connectors
- 2x USB 2.0 ports by edge connectors, 4x USB 2.0 ports by 2x 5-pin header pitch 2.54mm, 2x Vertical Type A USB Connectors
- GPIO : Support 4 x GPI and 4 x GPO with TTL level(0/5V)
- 1x 3-pin and 1x 4-pin fan connectors for CPU
- 1x 3-pin and 1x 4-pin fan connectors for System
- 1x 18-pin header for TPM
- 1x 26-pin header for Parallel port
- 1x Onboard buzzer
- Power LED/ Power On/ Reset/ HDD LED pin header



### Watchdog Timer

- Watchdog timeout can be programmable by Software from 1 second to 255 seconds and from 1 minute to 255 minutes (Tolerance 15% under room temperature 25°C)

### Storage

- 5x SATA3.0 ports with RAID 0,1,5,10 function.
- 1x mSATA

### System Monitor

- 4 voltages (Vcore, +12V, +3.3V, 5V)
- 2 temperatures (CPU and System)
- 4 fan speed detection

### On-board RTC

- On-chip RTC with battery backup
- 1x External Li-Ion battery

### System Monitor

- 4 Voltages (+3.3V, +5V, +12V, Vcore)
- 2 Temperatures (CPU and System)
- 4 FAN speed monitors (2 for CPU and 2 for System)

### Power Input

- Support AT/ ATX mode
- Standard ATX 24-pin connector for +12V/ +5V/ +3.3V/ +5VSB/ -12V
- ATX 4-pin connector for +12V

### Dimensions

- ATX
- Dimension: Lx W, 305mm x 244mm; 12"x 9.6"

### Environment

- Board level operating temperatures: 0°C to 60°C
- Storage temperature: -20°C to 85°C
- Relative humidity: 10% to 90%, (Non-condensing)

### Certifications

- CE approval
- FCC Class A

# Knowing Your NEX 981

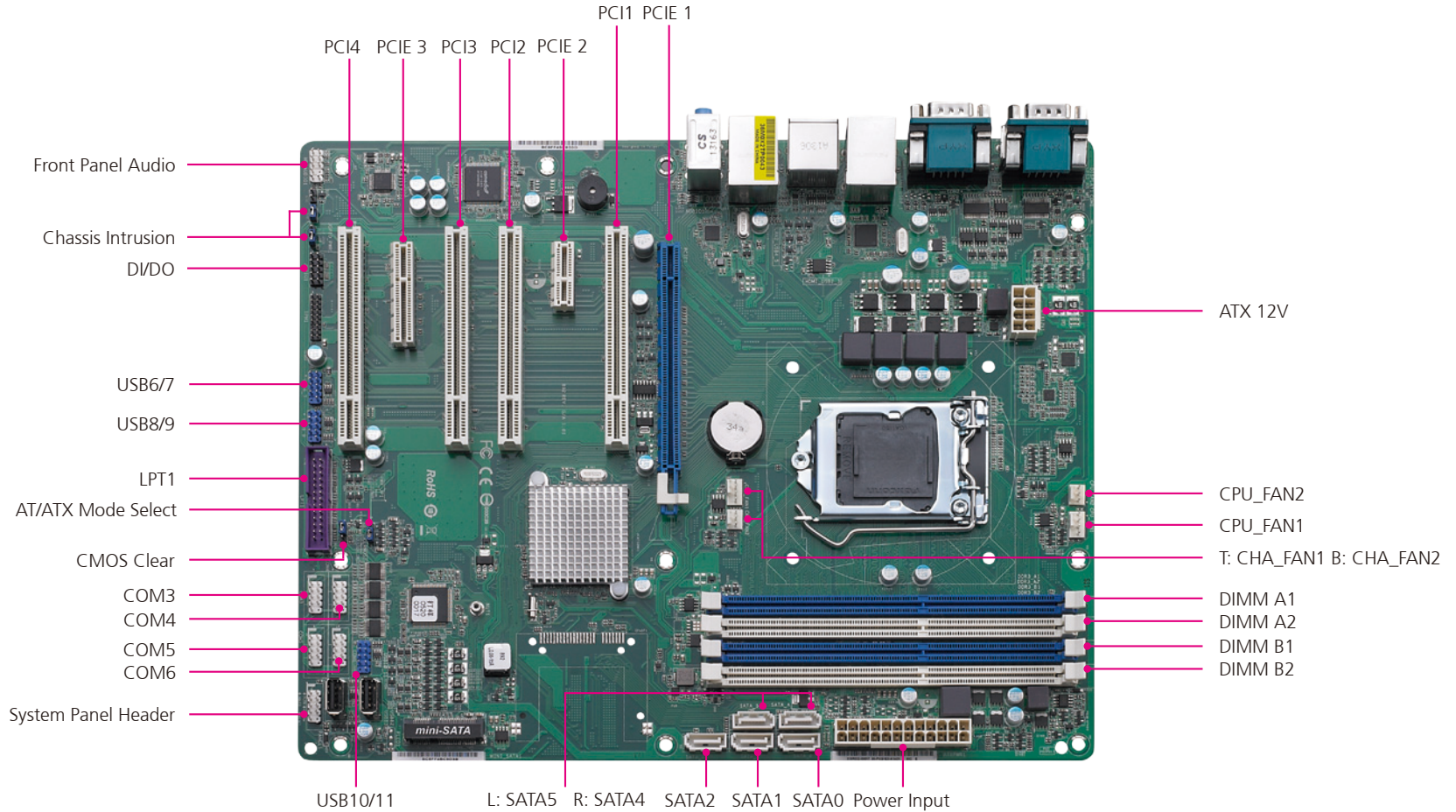

## Edge I/O View

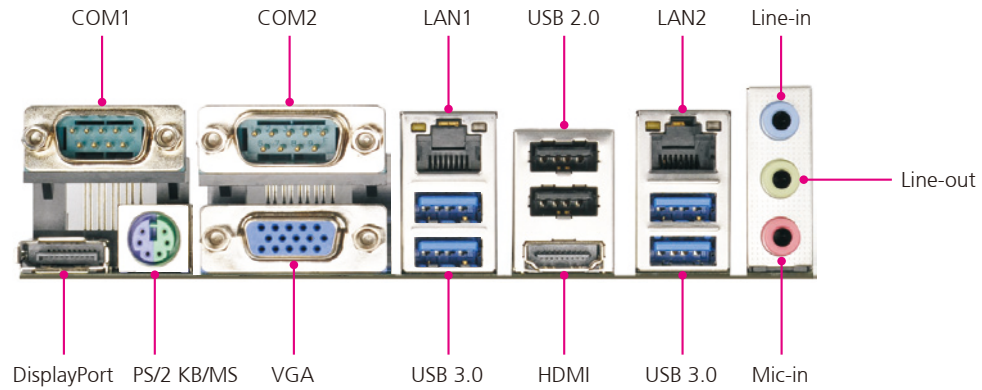

# Chapter 2: Jumpers and Connectors

This chapter describes how to set the jumpers and connectors on the NEX 981 motherboard.

## Before You Begin

- Ensure you have a stable, clean working environment. Dust and dirt can get into components and cause a malfunction. Use containers to keep small components separated.
- Adequate lighting and proper tools can prevent you from accidentally damaging the internal components. Most of the procedures that follow require only a few simple tools, including the following:
  - A Philips screwdriver
  - A flat-tipped screwdriver
  - A set of jewelers screwdrivers
  - A grounding strap
  - An anti-static pad
- Using your fingers can disconnect most of the connections. It is recommended that you do not use needle-nosed pliers to disconnect connections as these can damage the soft metal or plastic parts of the connectors.
- Before working on internal components, make sure that the power is off. Ground yourself before touching any internal components, by touching a metal object. Static electricity can damage many of the electronic components. Humid environments tend to have less static electricity than

dry environments. A grounding strap is warranted whenever danger of static electricity exists.

## Precautions

Computer components and electronic circuit boards can be damaged by discharges of static electricity. Working on computers that are still connected to a power supply can be extremely dangerous.

Follow the guidelines below to avoid damage to your computer or yourself:

- Always disconnect the unit from the power outlet whenever you are working inside the case.
- If possible, wear a grounded wrist strap when you are working inside the computer case. Alternatively, discharge any static electricity by touching the bare metal chassis of the unit case, or the bare metal body of any other grounded appliance.
- Hold electronic circuit boards by the edges only. Do not touch the components on the board unless it is necessary to do so. Don't flex or stress the circuit board.
- Leave all components inside the static-proof packaging that they shipped with until they are ready for installation.
- Use correct screws and do not over tighten screws.

## Jumper Settings

A jumper is the simplest kind of electric switch. It consists of two metal pins and a cap. When setting the jumpers, ensure that the jumper caps are placed on the correct pins. When the jumper cap is placed on both pins, the jumper is short. If you remove the jumper cap, or place the jumper cap on just one pin, the jumper is open.

Refer to the illustrations below for examples of what the 2-pin and 3-pin jumpers look like when they are short (on) and open (off).

Two-Pin Jumpers: Open (Left) and Short (Right)

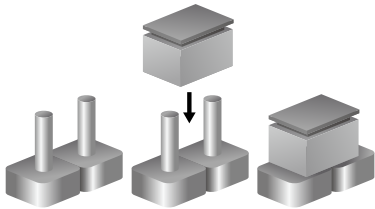

Three-Pin Jumpers: Pins 1 and 2 are Short

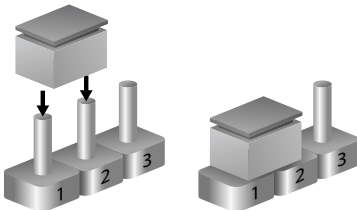

# Locations of the Jumpers and Connectors

The figure below shows the location of the jumpers and connectors.

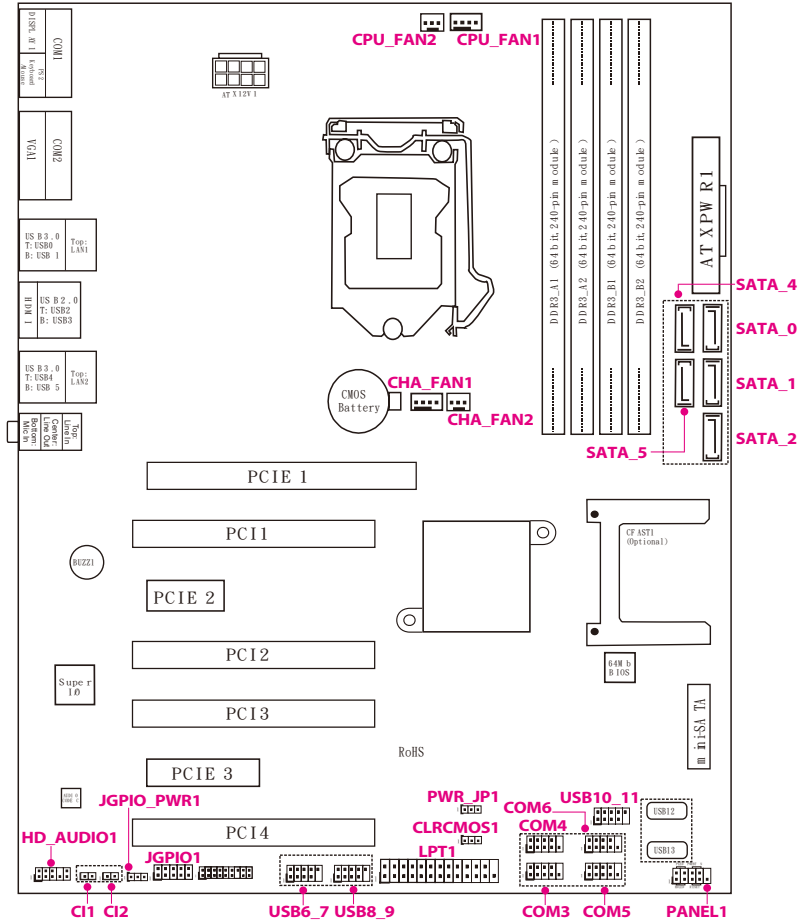

## Jumpers

### CMOS Clear Select

Connector type: 1x3 3-pin header

Connector location: CLRCOMOS1



Pin	Settings
1-2	Normal
2-3	Clear CMOS

### ATX/AT Mode Jumper

Connector type: 1x3 3-pin header

Connector location: PWR\_JP1



Pin	Settings
1-2	AT Mode
2-3	ATX Mode

## Digital Input/Output Power Select

Connector type: 1x3 3-pin header

Connector location: JGPIO\_PWR1



Pin	Settings
1-2	+12V
2-3	+12V



## Connector Pin Definitions

### Internal Connectors

#### 3-Pin CPU Fan Connector (+12V)

Connector type: 1x3 3-pin header

Connector location: CPU\_FAN2 and CHA\_FAN2



Pin	Definition
1	GND
2	+12V
3	CPU_FAN_SPEED

#### RS-232 Port 4 Pin Headers

Connector type: 2x5 10-pin header

Connector location: COM3, COM4, COM5 and COM6

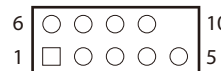

Pin	Definition	Pin	Definition
1	DDCD#1	2	TTXD1
3	GND	4	RRTS#1
5	RRI#1	6	RRXD1
7	DDTR#1	8	DDSR#1
9	CCTS#1		

## System Panel Header

Connector type: 2x5 10-pin header

Connector location: PANEL1

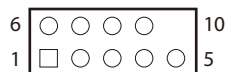

Pin	Definition	Pin	Definition
1	HDLED+	2	HDLED-
3	GND	4	RESET#
5	GND	6	PLED+
7	PLED-	8	PWRBTN#
9	GND		

## 4-Pin Chassis Fan Connector (+12V)

Connector type: 1x4 4-pin header

Connector location: CPU\_FAN1 and CHA\_FAN1

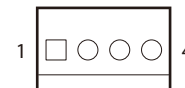

Pin	Definition	Pin	Definition
1	GND	2	+12V
3	CPU_FAN_SPEED	4	FAN_SPEED_CONTROL

## Digital Input/Output Pin Headers

Connector type: 2x5 10-pin header

Connector location: JGPIO1

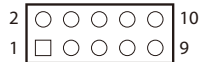

Pin	Definition	Pin	Definition
1	Digital Output 0	2	Digital Input 0
3	Digital Output 1	4	Digital Input 1
5	Digital Output 2	6	Digital Input 2
7	Digital Output 3	8	Digital Input 3
9	JGPIO_PWR1	10	GND

## USB2.0 Connectors

Connector type: 2x5 10-pin header

Connector location: USB6\_7, USB8\_9 and USB10\_11

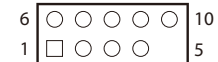

Pin	Definition	Pin	Definition
1	PWR	2	-
3	+	4	GND
5		6	PWR
7	-	8	+
9	GND	10	NC

## Printer Port Header

Connector type: 2x5 10-pin header

Connector location: LPT1

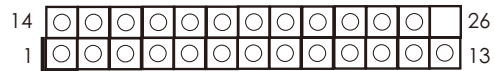

Pin	Definition	Pin	Definition
1	STB#	2	SPD0
3	SPD1	4	SPD2
5	SPD3	6	SPD4
7	SPD5	8	SPD6
9	SPD7	10	ACK#
11	BUSY	12	PE
13	SLCT	14	AFD#
15	ERROR#	16	PINIT#
17	SLIN#	18	GND
19	GND	20	GND
21	GND	22	GND
23	GND	24	GND
25	GND		

## Front Panel Audio Header

Connector type: 2x5 10-pin header

Connector location: HD\_AUDIO1

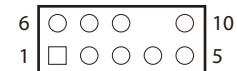

Pin	Definition	Pin	Definition
1	MIC2_L	2	MIC2_R
3	OUT2_R	4	J_SENSE
5	OUT2_L	6	GND
7	PRESENCE#	8	MIC_RET
9		10	OUT_RET

## Chassis Intrusion Pin Headers

Connector type: 1x2 2-pin header

Connector location: CI1 and CI2



Pin	Definition
1	Signal
2	GND

# Block Diagram

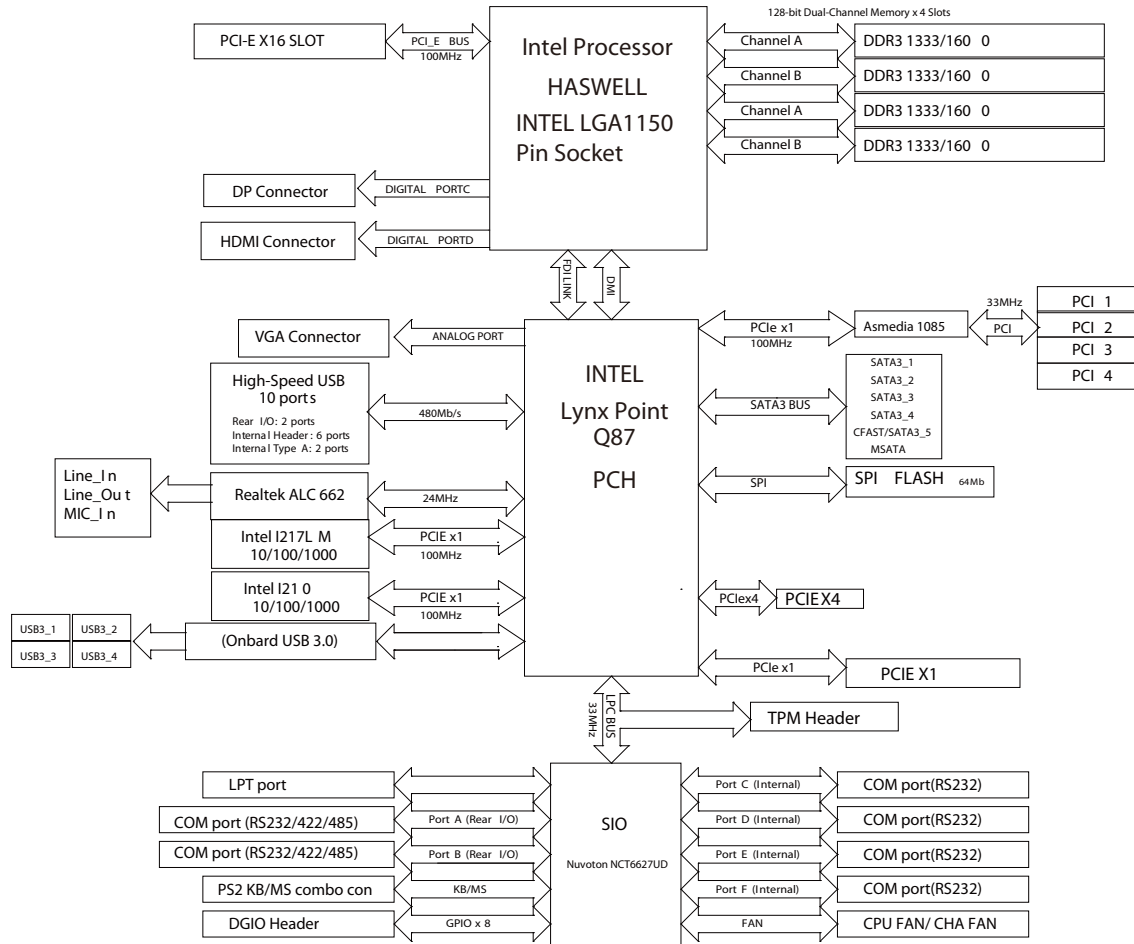

# Chapter 3: BIOS Setup

This chapter describes how to use the BIOS setup program for the NEX 981. The BIOS screens provided in this chapter are for reference only and may change if the BIOS is updated in the future.

To check for the latest updates and revisions, visit the NEXCOM Web site at [www.nexcom.com.tw](http://www.nexcom.com.tw).

## About BIOS Setup

The BIOS (Basic Input and Output System) Setup program is a menu driven utility that enables you to make changes to the system configuration and tailor your system to suit your individual work needs. It is a ROM-based configuration utility that displays the system's configuration status and provides you with a tool to set system parameters.

These parameters are stored in non-volatile battery-backed-up CMOS RAM that saves this information even when the power is turned off. When the system is turned back on, the system is configured with the values found in CMOS.

With easy-to-use pull down menus, you can configure such items as:

- Hard drives, diskette drives, and peripherals
- Video display type and display options
- Password protection from unauthorized use
- Power management features

The settings made in the setup program affect how the computer performs. It is important, therefore, first to try to understand all the setup options, and second, to make settings appropriate for the way you use the computer.

## When to Configure the BIOS

- This program should be executed under the following conditions:
  - When changing the system configuration
  - When a configuration error is detected by the system and you are prompted to make changes to the setup program
  - When resetting the system clock
  - When redefining the communication ports to prevent any conflicts
  - When making changes to the Power Management configuration
  - When changing the password or making other changes to the security setup

Normally, CMOS setup is needed when the system hardware is not consistent with the information contained in the CMOS RAM, whenever the CMOS RAM has lost power, or the system features need to be changed.

## Default Configuration

Most of the configuration settings are either predefined according to the Load Optimal Defaults settings which are stored in the BIOS or are automatically detected and configured without requiring any actions. There are a few settings that you may need to change depending on your system configuration.

## Entering Setup











When the system is powered on, the BIOS will enter the Power-On Self Test (POST) routines. These routines perform various diagnostic checks; if an error is encountered, the error will be reported in one of two different ways:

- If the error occurs before the display device is initialized, a series of beeps will be transmitted.
- If the error occurs after the display device is initialized, the screen will display the error message.

Powering on the computer and immediately pressing <Del> allows you to enter Setup.

Press the  key to enter Setup:

## Legends

Key	Function
	Moves the highlight left or right to select a menu.
	Moves the highlight up or down between sub-menu or fields.
	Exits the BIOS Setup Utility.
	Scrolls forward through the values or options of the highlighted field.
	Scrolls backward through the values or options of the highlighted field.
	Selects a field.
	Displays General Help.
	Load previous values.
	Load optimized default values.
	Saves and exits the Setup program.
	Press <Enter> to enter the highlighted sub-menu



### Scroll Bar

When a scroll bar appears to the right of the setup screen, it indicates that there are more available fields not shown on the screen. Use the up and down arrow keys to scroll through all the available fields.

### Submenu

When “▶” appears on the left of a particular field, it indicates that a submenu which contains additional options are available for that field. To display the submenu, move the highlight to that field and press  .

## BIOS Setup Utility

Once you enter the AMI BIOS Setup Utility, the Main Menu will appear on the screen. The main menu allows you to select from several setup functions and one exit. Use arrow keys to select among the items and press  to accept or enter the submenu.

### Main

The Main menu is the first screen that you will see when you enter the BIOS Setup Utility.

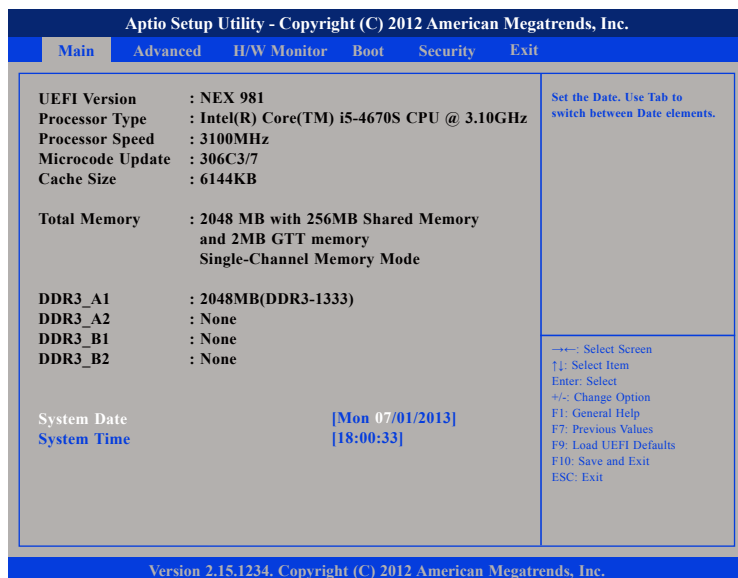

### System Date

The date format is <day>, <month>, <date>, <year>. Day displays a day, from Monday to Sunday. Month displays the month, from January to December. Date displays the date, from 1 to 31. Year displays the year, from 1999 to 2099.

### System Time

The time format is <hour>, <minute>, <second>. The time is based on the 24-hour military-time clock. For example, 1 p.m. is 13:00:00. Hour displays hours from 00 to 23. Minute displays minutes from 00 to 59. Second displays seconds from 00 to 59.

## Advanced

The Advanced menu allows you to configure your system for basic operation. Some entries are defaults required by the system board, while others, if enabled, will improve the performance of your system or let you set some features according to your preference.



Setting incorrect field values may cause the system to malfunction.



## CPU Configuration

This section is used to configure the CPU.

The screenshot shows the 'Advanced' section of the Aptio Setup Utility. The main display area is divided into two columns. The left column lists various CPU-related settings, and the right column provides a legend for navigation keys. The settings listed are:

Intel(R) Core(TM) i5-4670S CPU @ 3.10GHz		Select the number of cores to enable in each processor package.
Max CPU Speed	3100 MHz	
Min CPU Speed	800 MHz	
Processor Cores	4	
Intel HT Technology	Not Supported	
Intel VT-x Technology	Supported	
Intel SMX Technology	Supported	
64-bit	Supported	
Active Processor Cores	[All]	
CPU C States Support	[Auto]	
Enhanced Halt State(C1E)	[Auto]	
CPU C3 State Support	[Auto]	
CPU C6 State Support	[Auto]	
CPU C7 State Support	[Auto]	
Package C State Support	[Auto]	
Intel SpeedStep Technology	[Enabled]	
Intel Turbo Boost Technology	[Enabled]	
CPU Thermal Throttling	[Enabled]	
No-Execute Memory Protection	[Enabled]	
Intel Virtualization Technology	[Enabled]	
Hardware Prefetcher	[Enabled]	
Adjacent Cache Line Prefetch	[Enabled]	

Navigation legend:

- ←→: Select Screen
- ↑↓: Select Item
- Enter: Select
- +/-: Change Option
- F1: General Help
- F7: Discard Changes
- F9: Load UEFI Defaults
- F10: Save and Exit
- ESC: Exit

Version 2.15.1234. Copyright (C) 2012 American Megatrends, Inc.

### Active Processors Cores

Select the number of cores to enable in each processor package.

### CPU C States Support

Enable CPU C States Support for power saving. It is recommended to keep C3, C6 and C7 all enabled for better power saving.

### Enhanced Halt State (C1E)

Enable Enhanced Halt State (C1E) for lower power consumption.

### CPU C3 State Support

Used to enable or disable CPU C3 (ACPI C2) report to OS.

### CPU C6 State Support

Used to enable or disable CPU C6 (ACPI C6) report to OS.

### CPU C7 State Support

Used to enable or disable CPU C7 (ACPI C7) report to OS.

### Package C State Support

Selected option will program into C State package limit register.

### Intel® SpeedStep Technology

Enables or disables Intel® SpeedStep.

### Intel® Turbo Boost Technology

Enables or disables Intel® Turbo Boost.

### CPU Thermal Throttling

Enables or disables internal thermal control of the CPU to prevent overheating.

### No-Execute Memory Protection

Enables or disables No-Execute Memory Protection, enabling it will prevent data pages from being used by malicious software.

### Intel® Virtualization Technology

When this field is set to Enabled, the VMM can utilize the additional hardware capabilities provided by Vanderpool Technology.

### Hardware Prefetcher

Turns on or off the MLC streamer prefetcher.

### Adjacent Cache Line Prefetch

Enables or disables the adjacent cache line prefetch.

## Chipset Configuration

This section is used to configure the chipset features.

Aptio Setup Utility - Copyright (C) 2012 American Megatrends, Inc.		
Advanced		
VT-d Capability	Supported	If [Auto] is selected, the motherboard will detect the memory module(s) inserted and assign the appropriate frequency automatically.
DRAM Frequency	[Auto]	
Primary Graphics Adapter	[PCI Express]	
VT-d	[Disabled]	
PCIe1 Link Speed	[Auto]	
PCIe2 Link Speed	[Auto]	
PCIe3 Link Speed	[Auto]	
Share Memory	[Auto]	
IGPU Multi-Monitor	[Disabled]	
Render Standby	[Enabled]	
Onboard HD Audio	[Enabled]	--- Select Screen ↑↓ Select Item Enter: Select +/- Change Option F1: General Help F7: Discard Changes F9: Load UEFI Defaults F10: Save and Exit ESC: Exit
Front Panel	[Auto]	
Onboard HDMI HD Audio	[Enabled]	
Onboard LAN1	[Enabled]	
Onboard LAN2	[Enabled]	
Deep Sleep	[Disabled]	
Restore on AC/Power Loss	[Power Off]	

Version 2.15.1234. Copyright (C) 2012 American Megatrends, Inc.

### DRAM Frequency

Select Auto to automatically set DRAM frequency.

### Primary Graphics Adapter

Selects which primary graphics adapter to boot the system.

### VT-d

Enables or disables Intel® VT-d technology.

### PCIe1 to PCIe3 Link Speed

Configures the link speed of PCIe1 to PCIe3.

### Share Memory

Configures the amount of memory shared to the onboard graphics.

### IGPU Multi-Monitor

Enables or disables the onboard graphics.

### Render Standby

Enables or disables render standby of onboard graphics.

### Onboard HD Audio

Enables or disables the onboard HD audio, setting auto will automatically disable the onboard HD audio when an external sound card is installed.

### Front Panel

Enables or disables the onboard HD audio front panel.

### Onboard HDMI HD Audio

Enables or disables the onboard HDMI HD audio.

### Onboard LAN1 to LAN2

Enables or disables onboard LAN1 and LAN2.

### Deep Sleep

Enables or disables deep sleep (S4/S5). Deep sleep for mobile platforms is supported in DC only, and supported in AC only for desktop platforms.

### Restore on AC/Power Loss

**Power Off** When power returns after an AC power failure, the system's power is off. You must press the Power button to power-on the system.

**Power On** When power returns after an AC power failure, the system will automatically power-on.

## Storage Configuration

This section is used to configure the storage features.

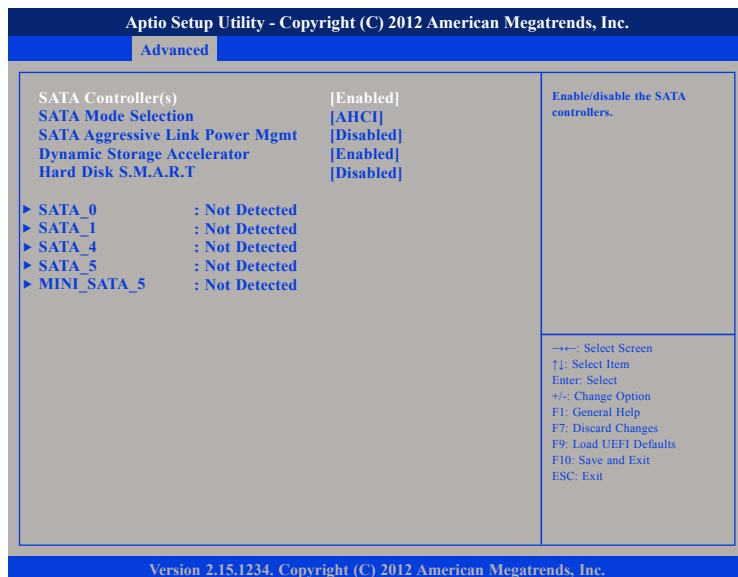

### SATA Controller(s)

Enables or disables the SATA controller.

### SATA Mode Selection

Configures the SATA as IDE, AHCI or RAID mode.

- IDE This option configures the Serial ATA drives as Parallel ATA physical storage device.
- RAID This option allows you to create RAID or Intel Matrix Storage configuration on Serial ATA devices.
- AHCI This option configures the Serial ATA drives to use AHCI (Advanced Host Controller Interface). AHCI allows the storage driver to enable the advanced Serial ATA features which will increase storage performance.

### SATA Aggressive Link Power Management

Enables or disables the SATA aggressive link power management.

### Dynamic Storage Accelerator

Enables or disables dynamic storage accelerator, enabling it will increase HDD and SSD I/O performance.

### Hard Disk S.M.A.R.T

Enables or disables hard disk S.M.A.R.T feature.

### Intel® Rapid Start Technology

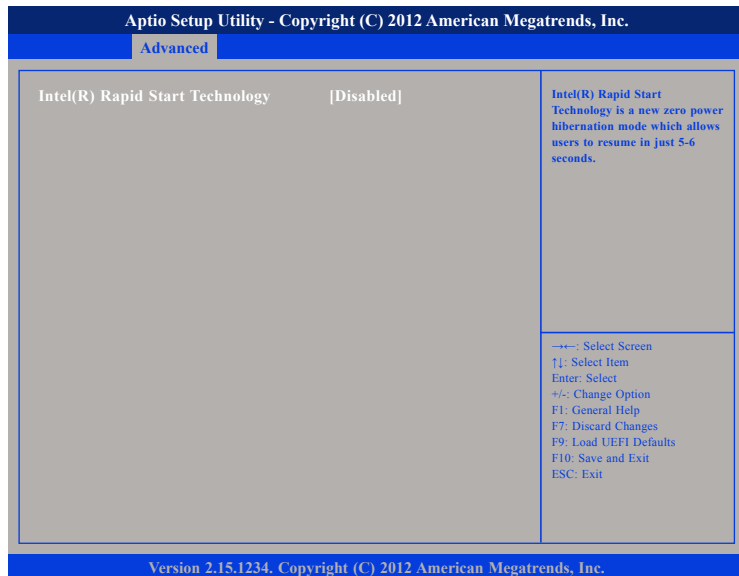

### Intel® Rapid Start Technology

Enables or disables Intel® Rapid Start Technology. Intel® Rapid Start Technology is a new zero power hibernation mode which allows users to resume in just 5-6 seconds.

### Intel® Smart Connect Technology



### Intel® Smart Connect Technology

Enables or disables Intel® Smart Connect Technology. Intel® Smart Connect Technology keeps your e-mail and social networks, such as Twitter, Facebook, etc. updated automatically while the computer is in sleep mode.

## Intel® AMT Technology

This section is used to configure the AMT function.

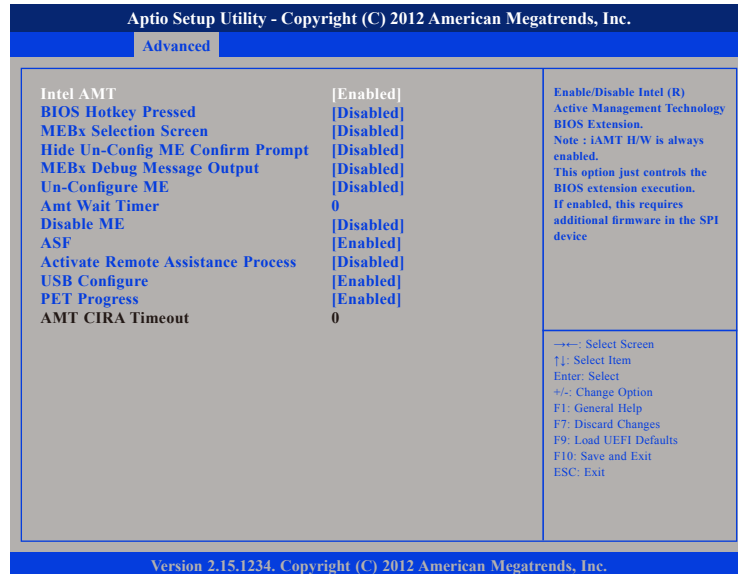

### Intel® AMT

Enables or disables Intel® Active Management Technology.

### BIOS Hotkey Pressed

Enables or disables BIOS hotkey pressed.

### MEBx Selection Screen

Enables or disables MEBx selection screen.

### Hide Un-Configure ME Confirm Prompt

Hide Un-Configure ME without password confirmation prompt.

### MEBx Debug Message Output

Enables or disables MEBx debug message output.

### Un-Configure ME

Enables or disables Un-configure ME without password.

### AMT Wait Timer

Set timer to wait before sending ASF\_GET\_BOOT\_OPTIONS.

### Disable ME

Set ME to Soft Temporary Disabled.

### ASF

Enables or disables alert specification format.

### Activate Remote Assistance Process

Enables or disables Trigger CIRA boot.

### USB Configure

Enables or disables USB configure function.

### PET Progress

Enables or disables PET Events progress to receive PET event.



## Super IO Configuration

This section is used to configure the serial and parallel ports.

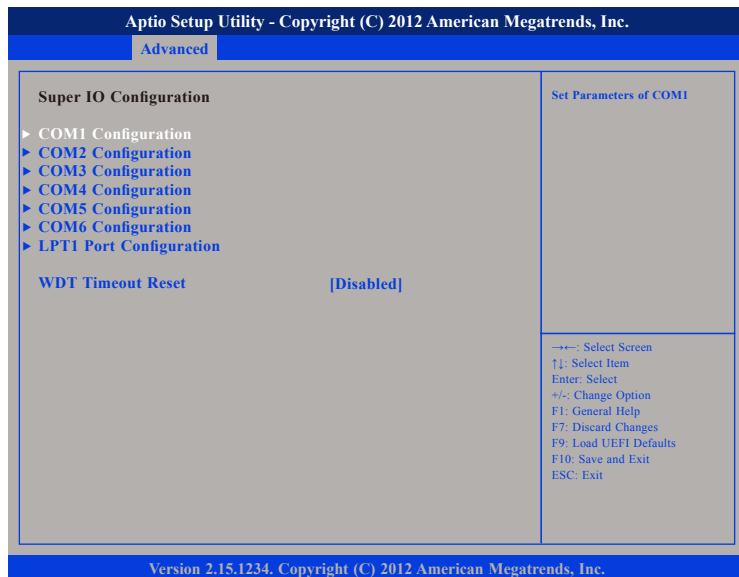

### COM1 to COM6 Configuration

Configures the parameters of COM1 to COM6.

### LPT1 Port Configuration

Configures the parameters of LPT1.

### WDT Timeout Reset

Enables or disables the Watchdog Timer timeout to reset the system.

## ACPI Settings

This section is used to configure ACPI settings.

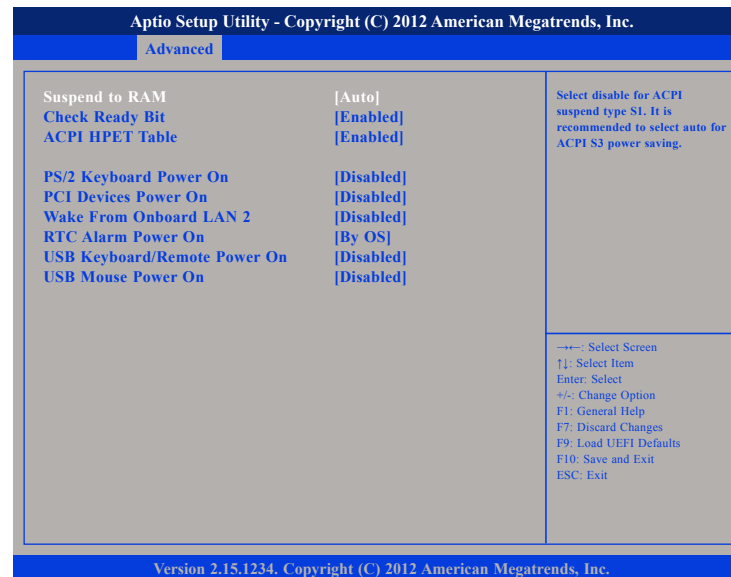

### Suspend to RAM

Select disable for ACPI suspend type S1. It is recommended to select auto for ACPI S3 power saving.

### Check Ready Bit

Enables or disables Check Ready Bit.

### ACPI HPET Table

Enables or disables ACPI HPET Table.

### PS/2 Keyboard Power On

Enables or disables PS/2 keyboard to turn on the system from the power-soft-off mode.

### PCI Devices Power On

Enables or disables PCI devices to turn on the system from the power-soft-off mode.

### Wake From Onboard LAN 2

Enables or disables wake up from onboard LAN 2.

### RTC Alarm Power On

Enables or disables real time clock (RTC) to power on the system.

### USB Keyboard/Remote Power On

Enables or disables USB Keyboard/Remote to power on the system.

### USB Mouse Power On

Enables or disables USB mouse to power on the system.

## USB Configuration

This section is used to configure the USB.

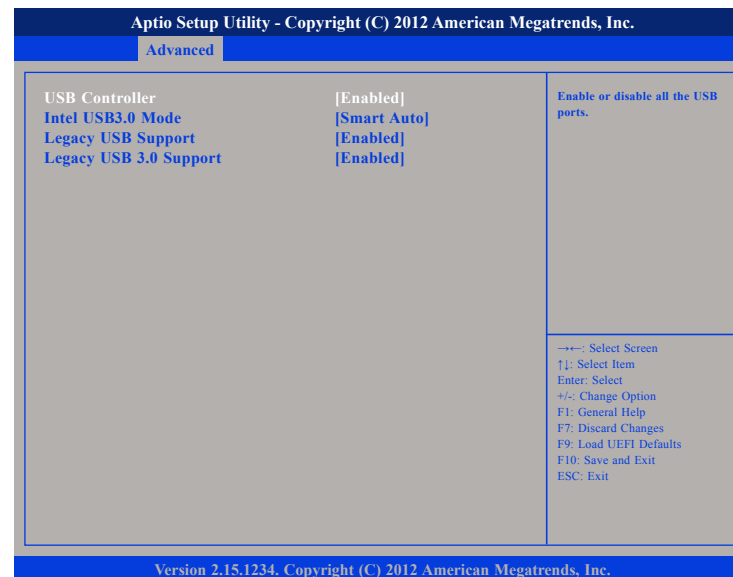

### USB Controller

Enables or disables all the USB ports.

### Intel® USB3.0 Mode

Enables or disables USB 3.0 mode.

### Legacy USB Support

Enabled Enables Legacy USB.

Auto Disables support for Legacy when no USB devices are connected.

Disabled Keeps USB devices available only for EFI applications.

### Legacy USB 3.0 Support

Enables or disables legacy support for USB 3.0 devices.

## Voltage Configuration

This section is used to configure the DRAM voltage.

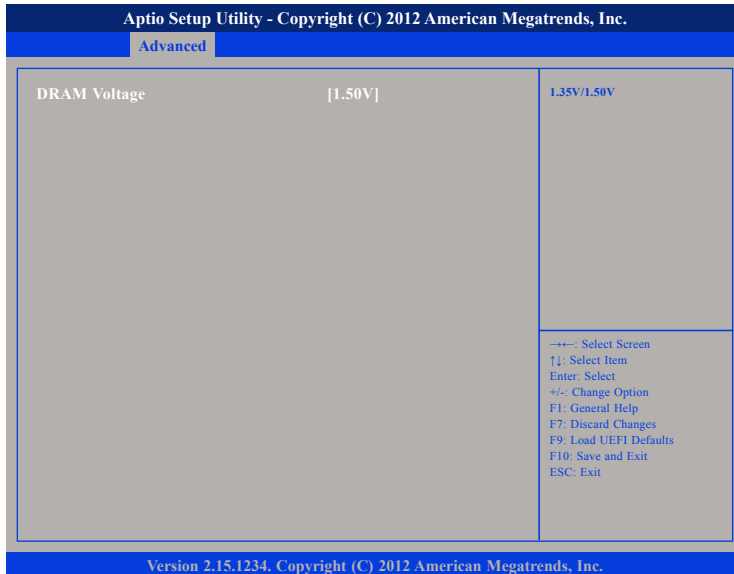

### DRAM Voltage

Selects the DRAM voltage value.

## H/W Monitor

This section is used to monitor hardware status such as temperature, fan speed and voltages.

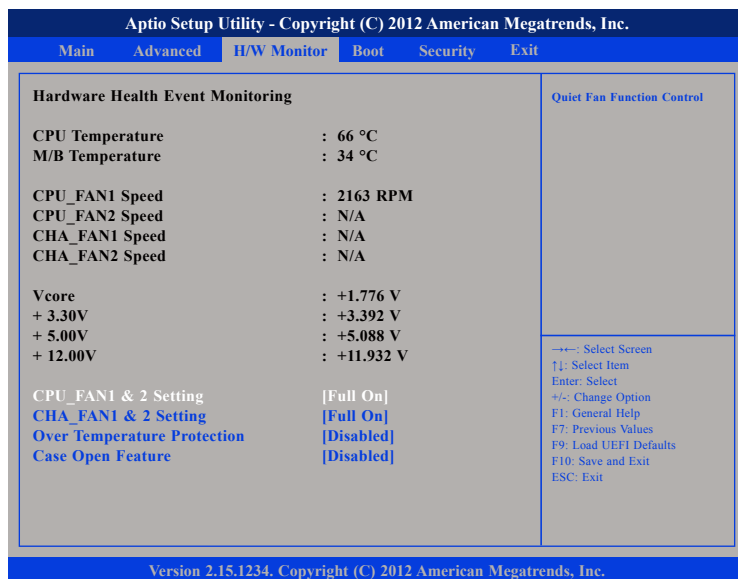

### CPU Temperature

Detects and displays the current CPU temperature.

### M/B Temperature

Detects and displays the current motherboard temperature.

### CPU\_FAN1 to CPU\_FAN2 Speed

Detects and displays the fan speed of CPU\_FAN1 and CPU\_FAN2.

### CHA\_FAN1 to CHA\_FAN2 Speed

Detects and displays the fan speed of CHA\_FAN1 and CHA\_FAN2.

### Vcore

Detects and displays the Vcore CPU voltage.

### + 3.30V

Detects and displays 3.3V voltage.

### + 5.00V

Detects and displays 5V voltage.

### + 12.00V

Detects and displays 12V voltage.

### CPU\_FAN1 & 2 Setting

Configures the fan speed of CPU\_FAN1 and CPU\_FAN2.

### CHA\_FAN1 & 2 Setting

Configures the fan speed of CHA\_FAN1 and CHA\_FAN2.

### Over Temperature Protection

Enables or disables Over Temperature Protection.

### Case Open Feature

Enables or disables the case open detection feature.

## Boot

This section is used to configure the boot features.

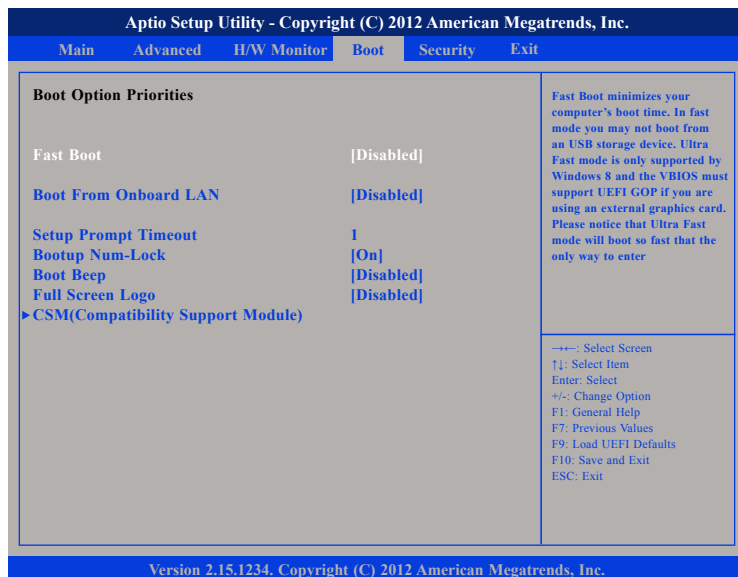

### Fast Boot

Fast boot minimizes your computer's boot time. The options are Disabled, Fast and Ultra Fast. In fast mode you may not boot from an USB storage device. Ultra Fast mode is only supported by Windows 8 and the VBIOS must support UEFI GOP if you are using an external graphics card.

### Boot From Onboard LAN

Enables or disables Boot From Onboard LAN.

### Setup Prompt Timeout

Number of seconds to wait for setup activation key. 65535(0XFFFF) means indefinite waiting.

### Bootup Num-Lock

This allows you to determine the default state of the numeric keypad. By default, the system boots up with NumLock on wherein the function of the numeric keypad is the number keys. When set to Off, the function of the numeric keypad is the arrow keys.

### Boot Beep

Enables or disables beep sound during system boot, a buzzer is needed.

### Full Screen Logo

Enables or disables the display of OEM logo.

### CSM (Compatibility Support Module)

Configuration for CSM, please disable CSM when Fast Boot is enabled.

## Compatibility Support Module (CSM) Configuration

This section is used to configure the compatibility support module features.

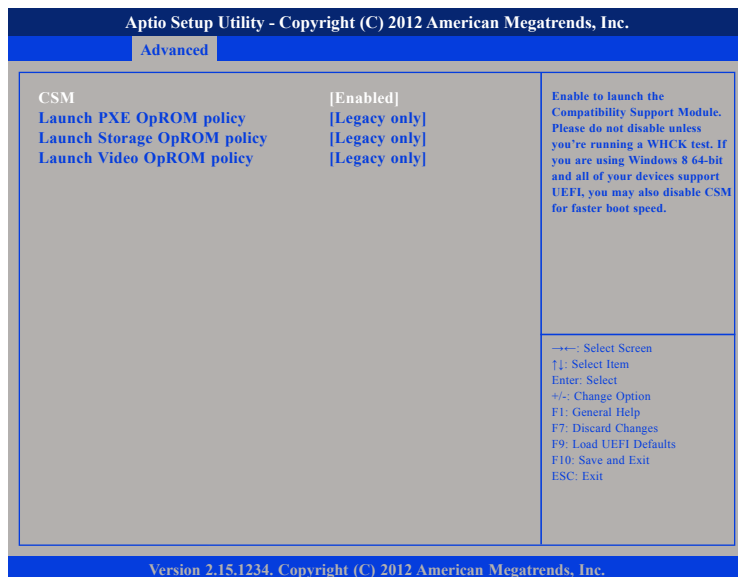

**CSM**  
Enables or disables CSM. Enabled to launch the Compatibility Support Module. Please do not disable unless a WHCK test is running. If Windows 8 64-bit is used and all the devices support UEFI, CSM may be disabled for faster boot speed.

**Launch PXE OpROM Policy**  
Enables or disables the boot option for legacy network devices.

**Launch Storage OpROM Policy**  
Enables or disables the boot option for legacy storage devices.

**Launch Video OpROM Policy**  
Enables or disables the boot option for legacy video devices.

## Security



### Administrator Password

Select this to reconfigure the administrator's password.

### User Password

Select this to reconfigure the user's password.

### Secure Boot

Enables or disables Secure Boot.

## Exit



### Save Changes and Exit

To save the changes and exit, select this field then press <Enter>. A dialog box will appear. Confirm by selecting Yes.

### Discard Changes and Exit

To exit the Setup utility without saving the changes, select this field then press <Enter>. You may be prompted to confirm again before exiting.

### Discard Changes

To discard all the changes, select this field then press <Enter>. A dialog box will appear. Confirm by selecting Yes.

### Load UEFI Defaults

To restore the BIOS to default settings, select this field then press <Enter>. A dialog box will appear. Confirm by selecting Yes.