



NEXCOM International Co., Ltd.

Intelligent Platform & Services Business Unit

Digital Signage Platform

NDiS S538

User Manual

CONTENTS

Preface

Copyright	iv
Disclaimer	iv
Acknowledgements	iv
Regulatory Compliance Statements	iv
Declaration of Conformity	iv
RoHS Compliance	v
Warranty and RMA	vi
Safety Information	viii
Installation Recommendations	viii
Safety Precautions	ix
Technical Support and Assistance	x
Conventions Used in this Manual	x
Global Service Contact Information	xi
Package Contents	xiii
Ordering Information	xiv

Chapter 1: Product Introduction

Overview	1
Key Features	1
Physical Features	2
Front Panel	2
Rear Panel	3
Hardware Specifications	4
Mechanical Dimensions	5

Chapter 2: Jumpers and Connectors

Before You Begin	6
Precautions	6
Locations of the Jumpers and Connectors for NDiB S538	7
Jumper Settings	8
Jumpers	9
RTC Clear	9
Connector Pin Definitions	10
External I/O Interfaces	10
Power Switch	10
System Reset Switch	10
LAN Connector	11
USB 3.0 Connectors	11
Mini DisplayPort Connector	12
LED	12
PCIe x8 Connector (Gold Finger)	13
Internal Connectors	15
USB Connector	15
Debug 80 Port Connector	15
RTC Battery Connector	16
Fan Connector	16
M.2 E Key Connector	17
M.2 M Key Connector	18

Chapter 3: System Setup

Installing the CPU (Socket Type)	19
Installing a SO-DIMM Memory Module	21
Installing an M.2 SSD Storage Module	23
Installing a Wireless LAN Module	25
Installing the CPU Cooler	28

Chapter 4: BIOS Setup

About BIOS Setup	30
When to Configure the BIOS	30
Default Configuration	31
Entering Setup	31
Legends	31
BIOS Setup Utility	33
Main	33
Advanced	34
Chipset	41
Security	42
Boot	42
Save & Exit	43

Appendix A: NCT6106 Watchdog Programming Guide.....44

PREFACE

Copyright

This publication, including all photographs, illustrations and software, is protected under international copyright laws, with all rights reserved. No part of this manual may be reproduced, copied, translated or transmitted in any form or by any means without the prior written consent from NEXCOM International Co., Ltd.

Disclaimer

The information in this document is subject to change without prior notice and does not represent commitment from NEXCOM International Co., Ltd. However, users may update their knowledge of any product in use by constantly checking its manual posted on our website: <http://www.nexcom.com>. NEXCOM shall not be liable for direct, indirect, special, incidental, or consequential damages arising out of the use of any product, nor for any infringements upon the rights of third parties, which may result from such use. Any implied warranties of merchantability or fitness for any particular purpose is also disclaimed.

Acknowledgements

NDiS S538 is a trademark of NEXCOM International Co., Ltd. All other product names mentioned herein are registered trademarks of their respective owners.

Regulatory Compliance Statements

This section provides the FCC compliance statement for Class A devices and describes how to keep the system CE compliant.

Declaration of Conformity

FCC

This equipment has been tested and verified to comply with the limits for a Class A digital device, pursuant to Part 15 of FCC Rules. These limits are designed to provide reasonable protection against harmful interference when the equipment is operated in a commercial environment. This equipment generates, uses, and can radiate radio frequency energy and, if not installed and used in accordance with the instructions, may cause harmful interference to radio communications. Operation of this equipment in a residential area (domestic environment) is likely to cause harmful interference, in which case the user will be required to correct the interference (take adequate measures) at their own expense.

CE

The product(s) described in this manual complies with all applicable European Union (CE) directives if it has a CE marking. For computer systems to remain CE compliant, only CE-compliant parts may be used. Maintaining CE compliance also requires proper cable and cabling techniques.

RoHS Compliance



NEXCOM RoHS Environmental Policy and Status Update

NEXCOM is a global citizen for building the digital infrastructure. We are committed to providing green products and services, which are compliant with European Union RoHS (Restriction on Use of Hazardous Substance in Electronic Equipment) directive 2011/65/EU, to be your trusted green partner and to protect our environment.

RoHS restricts the use of Lead (Pb) < 0.1% or 1,000ppm, Mercury (Hg) < 0.1% or 1,000ppm, Cadmium (Cd) < 0.01% or 100ppm, Hexavalent Chromium (Cr6+) < 0.1% or 1,000ppm, Polybrominated biphenyls (PBB) < 0.1% or 1,000ppm, and Polybrominated diphenyl Ethers (PBDE) < 0.1% or 1,000ppm.

In order to meet the RoHS compliant directives, NEXCOM has established an engineering and manufacturing task force to implement the introduction of green products. The task force will ensure that we follow the standard NEXCOM development procedure and that all the new RoHS components and new manufacturing processes maintain the highest industry quality levels for which NEXCOM are renowned.

The model selection criteria will be based on market demand. Vendors and suppliers will ensure that all designed components will be RoHS compliant.

How to recognize NEXCOM RoHS Products?

For existing products where there are non-RoHS and RoHS versions, the suffix "(LF)" will be added to the compliant product name.

All new product models launched after January 2013 will be RoHS compliant. They will use the usual NEXCOM naming convention.

Warranty and RMA

NEXCOM Warranty Period

NEXCOM manufactures products that are new or equivalent to new in accordance with industry standard. NEXCOM warrants that products will be free from defect in material and workmanship for 2 years, beginning on the date of invoice by NEXCOM. HCP series products (Blade Server) which are manufactured by NEXCOM are covered by a three year warranty period.

NEXCOM Return Merchandise Authorization (RMA)

- Customers shall enclose the “NEXCOM RMA Service Form” with the returned packages.
- Customers must collect all the information about the problems encountered and note anything abnormal or, print out any on-screen messages, and describe the problems on the “NEXCOM RMA Service Form” for the RMA number apply process.
- Customers can send back the faulty products with or without accessories (manuals, cable, etc.) and any components from the card, such as CPU and RAM. If the components were suspected as part of the problems, please note clearly which components are included. Otherwise, NEXCOM is not responsible for the devices/parts.
- Customers are responsible for the safe packaging of defective products, making sure it is durable enough to be resistant against further damage and deterioration during transportation. In case of damages occurred during transportation, the repair is treated as “Out of Warranty.”
- Any products returned by NEXCOM to other locations besides the customers’ site will bear an extra charge and will be billed to the customer.

Repair Service Charges for Out-of-Warranty Products

NEXCOM will charge for out-of-warranty products in two categories, one is basic diagnostic fee and another is component (product) fee.

Repair Service Charges for Out-of-Warranty Products

NEXCOM will charge for out-of-warranty products in two categories, one is basic diagnostic fee and another is component (product) fee.

System Level

- Component fee: NEXCOM will only charge for main components such as SMD chip, BGA chip, etc. Passive components will be repaired for free, ex: resistor, capacitor.
- Items will be replaced with NEXCOM products if the original one cannot be repaired. Ex: motherboard, power supply, etc.
- Replace with 3rd party products if needed.
- If RMA goods can not be repaired, NEXCOM will return it to the customer without any charge.

Board Level

- Component fee: NEXCOM will only charge for main components, such as SMD chip, BGA chip, etc. Passive components will be repaired for free, ex: resistors, capacitors.
- If RMA goods can not be repaired, NEXCOM will return it to the customer without any charge.

Warnings

Read and adhere to all warnings, cautions, and notices in this guide and the documentation supplied with the chassis, power supply, and accessory modules. If the instructions for the chassis and power supply are inconsistent with these instructions or the instructions for accessory modules, contact the supplier to find out how you can ensure that your computer meets safety and regulatory requirements.

Cautions

Electrostatic discharge (ESD) can damage system components. Do the described procedures only at an ESD workstation. If no such station is available, you can provide some ESD protection by wearing an antistatic wrist strap and attaching it to a metal part of the computer chassis.

Safety Information

Before installing and using the device, note the following precautions:

- Read all instructions carefully.
- Do not place the unit on an unstable surface, cart, or stand.
- Follow all warnings and cautions in this manual.
- When replacing parts, ensure that your service technician uses parts specified by the manufacturer.
- Avoid using the system near water, in direct sunlight, or near a heating device.
- The load of the system unit does not solely rely for support from the rackmounts located on the sides. Firm support from the bottom is highly necessary in order to provide balance stability.
- The computer is provided with a battery-powered real-time clock circuit. There is a danger of explosion if battery is incorrectly replaced. Replace only with the same or equivalent type recommended by the manufacturer. Discard used batteries according to the manufacturer's instructions.

Installation Recommendations

Ensure you have a stable, clean working environment. Dust and dirt can get into components and cause a malfunction. Use containers to keep small components separated.

Adequate lighting and proper tools can prevent you from accidentally damaging the internal components. Most of the procedures that follow require only a few simple tools, including the following:

- A Philips screwdriver
- A flat-tipped screwdriver
- A grounding strap
- An anti-static pad

Using your fingers can disconnect most of the connections. It is recommended that you do not use needle-nose pliers to disconnect connections as these can damage the soft metal or plastic parts of the connectors.

Safety Precautions

1. Read these safety instructions carefully.
2. Keep this User Manual for later reference.
3. Disconnect this equipment from any AC outlet before cleaning. Use a damp cloth. Do not use liquid or spray detergents for cleaning.
4. For plug-in equipment, the power outlet socket must be located near the equipment and must be easily accessible.
5. Keep this equipment away from humidity.
6. Put this equipment on a stable surface during installation. Dropping it or letting it fall may cause damage.
7. The openings on the enclosure are for air convection to protect the equipment from overheating. **DO NOT COVER THE OPENINGS.**
8. Make sure the voltage of the power source is correct before connecting the equipment to the power outlet.
9. Place the power cord in a way so that people will not step on it. Do not place anything on top of the power cord. Use a power cord that has been approved for use with the product and that it matches the voltage and current marked on the product's electrical range label. The voltage and current rating of the cord must be greater than the voltage and current rating marked on the product.
10. All cautions and warnings on the equipment should be noted.
11. If the equipment is not used for a long time, disconnect it from the power source to avoid damage by transient overvoltage.
12. Never pour any liquid into an opening. This may cause fire or electrical shock.
13. Never open the equipment. For safety reasons, the equipment should be opened only by qualified service personnel.
14. If one of the following situations arises, get the equipment checked by service personnel:
 - a. The power cord or plug is damaged.
 - b. Liquid has penetrated into the equipment.
 - c. The equipment has been exposed to moisture.
 - d. The equipment does not work well, or you cannot get it to work according to the user's manual.
 - e. The equipment has been dropped and damaged.
 - f. The equipment has obvious signs of breakage.
15. Do not place heavy objects on the equipment.
16. The unit uses a three-wire ground cable which is equipped with a third pin to ground the unit and prevent electric shock. Do not defeat the purpose of this pin. If your outlet does not support this kind of plug, contact your electrician to replace your obsolete outlet.
17. **CAUTION: DANGER OF EXPLOSION IF BATTERY IS INCORRECTLY REPLACED. REPLACE ONLY WITH THE SAME OR EQUIVALENT TYPE RECOMMENDED BY THE MANUFACTURER. DISCARD USED BATTERIES ACCORDING TO THE MANUFACTURER'S INSTRUCTIONS.**

Technical Support and Assistance

1. For the most updated information of NEXCOM products, visit NEXCOM's website at www.nexcom.com.
2. For technical issues that require contacting our technical support team or sales representative, please have the following information ready before calling:
 - Product name and serial number
 - Detailed information of the peripheral devices
 - Detailed information of the installed software (operating system, version, application software, etc.)
 - A complete description of the problem
 - The exact wordings of the error messages

Warning!

1. Handling the unit: carry the unit with both hands and handle it with care.
2. Maintenance: to keep the unit clean, use only approved cleaning products or clean with a dry cloth.

Conventions Used in this Manual



Warning:

Information about certain situations, which if not observed, can cause personal injury. This will prevent injury to yourself when performing a task.



Caution:

Information to avoid damaging components or losing data.



Note:

Provides additional information to complete a task easily.

Global Service Contact Information

Headquarters

NEXCOM International Co., Ltd.

9F, No. 920, Chung-Cheng Rd.,
ZhongHe District, New Taipei City, 23586,
Taiwan, R.O.C.

Tel: +886-2-8226-7786

Fax: +886-2-8226-7782

www.nexcom.com

Asia

Taiwan

NexAIoT Co., Ltd.

Taipei Office

13F, No.920, Chung-Cheng Rd.,
ZhongHe District,
New Taipei City, 23586, Taiwan, R.O.C.

Tel: +886-2-8226-7796

Fax: +886-2-8226-7792

Email: sales@nexcom.com.tw

www.nexcom.com.tw

NexAIoT Co., Ltd.

Taichung Office

16F, No.250, Sec. 2, Chongde Rd.,
Beitun Dist.,

Taichung City 406, R.O.C.

Tel: +886-4-2249-1179

Fax: +886-4-2249-1172

Email: sales@nexcom.com.tw

www.nexcom.com.tw

NexCOBOT Taiwan Co., Ltd.

13F, No.916, Chung-Cheng Rd.,
ZhongHe District,
New Taipei City, 23586, Taiwan, R.O.C.

Tel: +886-2-8226-7796

Fax: +886-2-8226-7792

Email: sales@nexcom.com.tw

www.nexcom.com.tw

GreenBase Technology Corp.

13F, No.922, Chung-Cheng Rd.,
Zhonghe Dist.,
New Taipei City, 23586, Taiwan, R.O.C.

Tel: +886-2-8226-7786

Fax: +886-2-8226-7900

Email: sales@nexcom.com.tw

www.nexcom.com.tw

China

NEXSEC Incorporated

Floor 5, No.4, No.7 fengxian middle Rd.,
(Beike Industrial Park), Haidian District,
Beijing, 100094, China

Tel: +86-10-5704-2680

Fax: +86-10-5704-2681

Email: sales@nexcom.cn

www.nexcom.cn

NEXCOM Shanghai

Room 603/604, Huiyinmingzun Plaza Bldg., 1,
No. 609, Yunlin East Rd.,
Shanghai, 200062, China
Tel: +86-21-5278-5868
Fax: +86-21-3251-6358
Email: sales@nexcom.cn
www.nexcom.cn

NEXCOM Surveillance Technology Corp.

Floor 5, Building C, ZhenHan Industrial Zone,
GanKeng Community, Buji Street,
LongGang District,
ShenZhen, 518112, China
Tel: +86-755-8364-7768
Fax: +86-755-8364-7738
Email: steveyang@nexcom.com.tw
www.nexcom.cn

NEXCOM United System Service

Room 603/604, Huiyinmingzun Plaza Bldg. 1,
No. 609, Yunlin East Rd.,
Shanghai, 200062, China
Tel: +86-21-5278-5868
Fax: +86-21-3251-6358
Email: renwang@nexcom.com.tw
www.nexcom.cn

NEXGOL

1st Floor, Building B4, Electronic 2nd Area,
(Phoenix Lake Industrial Park), Yongchuan Dist.,
Chongqing City, 402160, China
Tel: +86-23-4960-9080
Fax: +86-23-4966-5855
Email: sales@nexcobot.com
www.nexgol.com/NexGoL

Beijing NexGemo Technology Co.,Ltd.

5th Floor, Gemotech Building, No.1, Development Rd.,
Changping International Information Industry Base,
Changping District,
Beijing, 102206, China
Tel: +86-10-8190-9399
Fax: +86-10-8190-9456

Japan**NEXCOM Japan**

9F, Tamachi Hara Bldg.,
4-11-5, Shiba Minato-ku,
Tokyo, 108-0014, Japan
Tel: +81-3-5419-7830
Fax: +81-3-5419-7832
Email: sales@nexcom-jp.com
www.nexcom-jp.com

Europe**United Kingdom
NEXCOM EUROPE**

10 Vincent Avenue,
Crownhill Business Centre,
Milton Keynes, Buckinghamshire
MK8 0AB, United Kingdom
Tel: +44-1908-267121
Fax: +44-1908-262042
Email: sales.uk@nexcom.eu
www.nexcom.eu

America**USA
NEXCOM USA**

2883 Bayview Drive,
Fremont CA 94538, USA
Tel: +1-510-656-2248
Fax: +1-510-656-2158
Email: sales@nexcom.com
www.nexcom.com

Package Contents

Before continuing, verify that the NDiS S538 package that you received is complete. Your package should have all the items listed in the following table.

Item	Part Number	Name	Description	Qty
1	5050200125X00	CPU Cooler for NDiS S538 VER:A Thermo Touch	168.4x74x15.9mm CU+Fan	1
2	5060200113X00	Thermal Pad APUS:290030003000200	30x30x0.2mm K=3.3w/mk PSX PXF-118-118-08	2
3	50311F0215X00	I Head Screw Long Fei:13x5ISO+Nylok NIGP	13x5 NI Nylok	1

Ordering Information

The following below provides ordering information for NDiS S538.

NDiS S538 (P/N: 10W00S53800X0)

Intel® Smart Display Module Large (Intel® SDM-L), 6th gen. Intel® Core™ LGA1151 type processor, Intel® Q170 chipset

CHAPTER 1: PRODUCT INTRODUCTION

Overview



NDiS S538 is designed for thinner and power efficiency display. There is no housing to limit display size and also easily integrate in signage player. NDiS S538 can be spanned from Celeron to Core™ processor and support All-in-One signage, interactive media player, and video wall. Also, allowing for easy storage capacity expansion through pluggable M.2 storage unit.

In addition, NDiS S538 leverages the 6th generation Intel® Core™ processors to deliver outstanding graphics and support for 3 independent 4K2K video outputs. The superb but power-efficient can therefore maximize visual impacts for digital signage applications.

Key Features

- Intel® Smart Display Module Large (Intel® SDM-L) design in
- 6th generation Intel® Core™ Skylake processor
- Intel® integrated HD 530 graphics engine
- Support 3 independent 4K2K video out
- Dual DDR4 SO-DIMM support
- Support Wi-Fi module

Physical Features

Front Panel

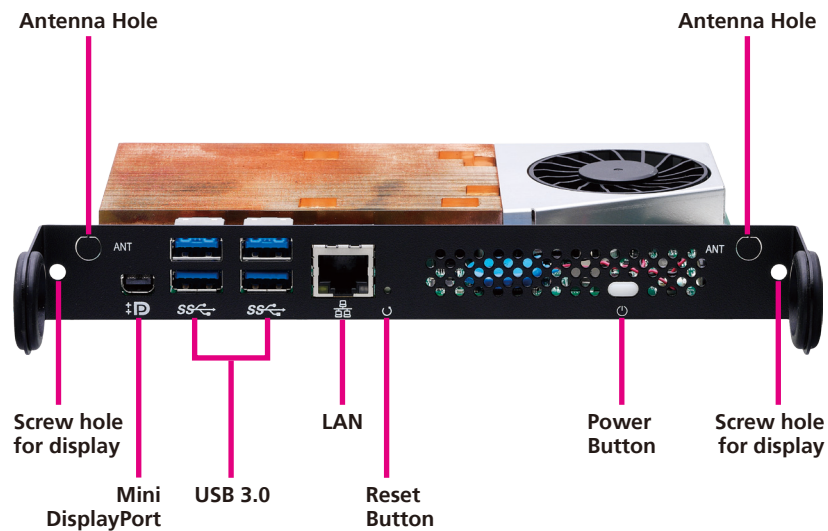

Rear Panel

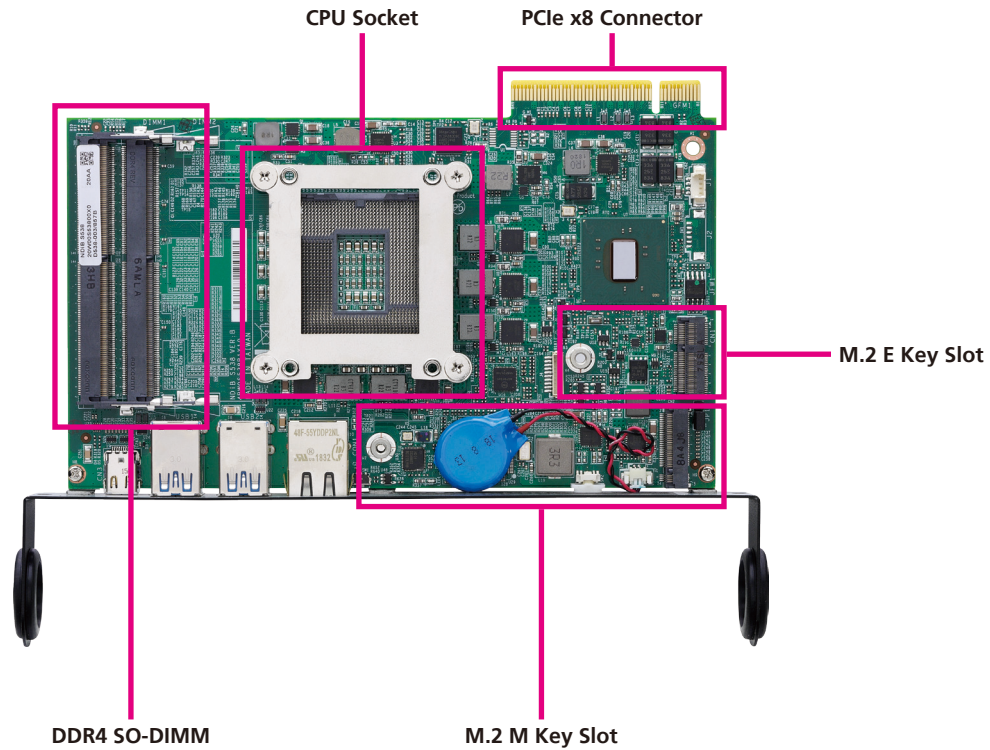

Hardware Specifications

CPU Support

- 6th generation Intel® Core™ processor (LGA1151), 35W

Chipset

- Intel® Q170 PCH

Graphics

- Integrated Intel® HD 530 graphics

Main Memory

- 2 x 260-pin SO-DIMM sockets, support DDR4 2133/2400 MHz non- ECC, un-buffered memory up to 32G (single socket max. 16GB).

I/O Interface-Front

- 1 x Power button with LED
- 1 x Reset button
- 1 x RJ45 with LEDs for Gigabit LAN
- 1 x Mini DP ++
- 4 x USB 3.0
- 2 x Antenna holes

I/O Interface-Rear (PCIe x8)

- 1 x HDMI 1.4 signal
- 1 x DisplayPort 1.2 signal
- 2 x I2C, master and slave ports signal
- 1 x GSPI signal
- 1 x PCIe by 1 signal
- System management

Storage Device

- 1 x M.2 2280, PCIe x4 + SATA

Expansion

- 1 x M.2 2230 for optional Wi-Fi module

Dimensions

- 175mm (W) x 100mm (D) x 20mm (H)

Power Supply

- DC power input +12V

Environment

- Operating temperature: ambient with air flow from 0°C to 55°C
- Storage temperature: -10°C to 70°C
- Humidity: 95% (non-condensing)

Certification

- CE/FCC Class A

Operating System

- Windows 10 64-bit/Linux

Mechanical Dimensions

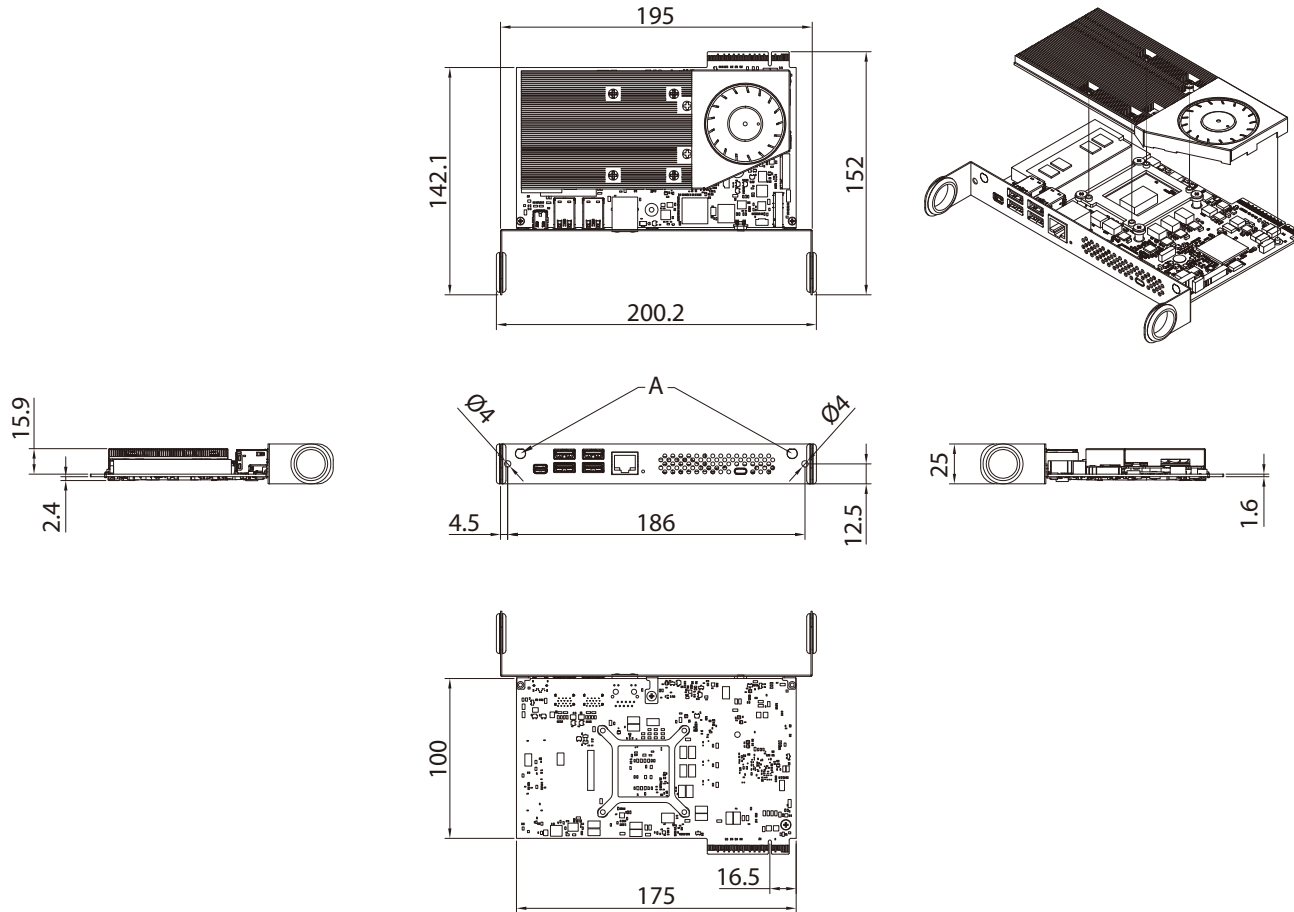

CHAPTER 2: JUMPERS AND CONNECTORS

This chapter describes how to set the jumpers and connectors on the NDiS S538 motherboard.

Before You Begin

- Ensure you have a stable, clean working environment. Dust and dirt can get into components and cause a malfunction. Use containers to keep small components separated.
- Adequate lighting and proper tools can prevent you from accidentally damaging the internal components. Most of the procedures that follow require only a few simple tools, including the following:
 - A Philips screwdriver
 - A flat-tipped screwdriver
 - A set of jewelers screwdrivers
 - A grounding strap
 - An anti-static pad
- Using your fingers can disconnect most of the connections. It is recommended that you do not use needle-nosed pliers to disconnect connections as these can damage the soft metal or plastic parts of the connectors.
- Before working on internal components, make sure that the power is off. Ground yourself before touching any internal components, by touching a metal object. Static electricity can damage many of the electronic components. Humid environments tend to have less static electricity than

dry environments. A grounding strap is warranted whenever danger of static electricity exists.

Precautions

Computer components and electronic circuit boards can be damaged by discharges of static electricity. Working on computers that are still connected to a power supply can be extremely dangerous.

Follow the guidelines below to avoid damage to your computer or yourself:

- Always disconnect the unit from the power outlet whenever you are working inside the case.
- If possible, wear a grounded wrist strap when you are working inside the computer case. Alternatively, discharge any static electricity by touching the bare metal chassis of the unit case, or the bare metal body of any other grounded appliance.
- Hold electronic circuit boards by the edges only. Do not touch the components on the board unless it is necessary to do so. Don't flex or stress the circuit board.
- Leave all components inside the static-proof packaging that they shipped with until they are ready for installation.
- Use correct screws and do not over tighten screws.

Locations of the Jumpers and Connectors for NDiB S538

The figure below is the top view of the NDiB S538 mainboard which is the mainboard used in NDiS S538. It shows the locations of the jumpers and connectors.

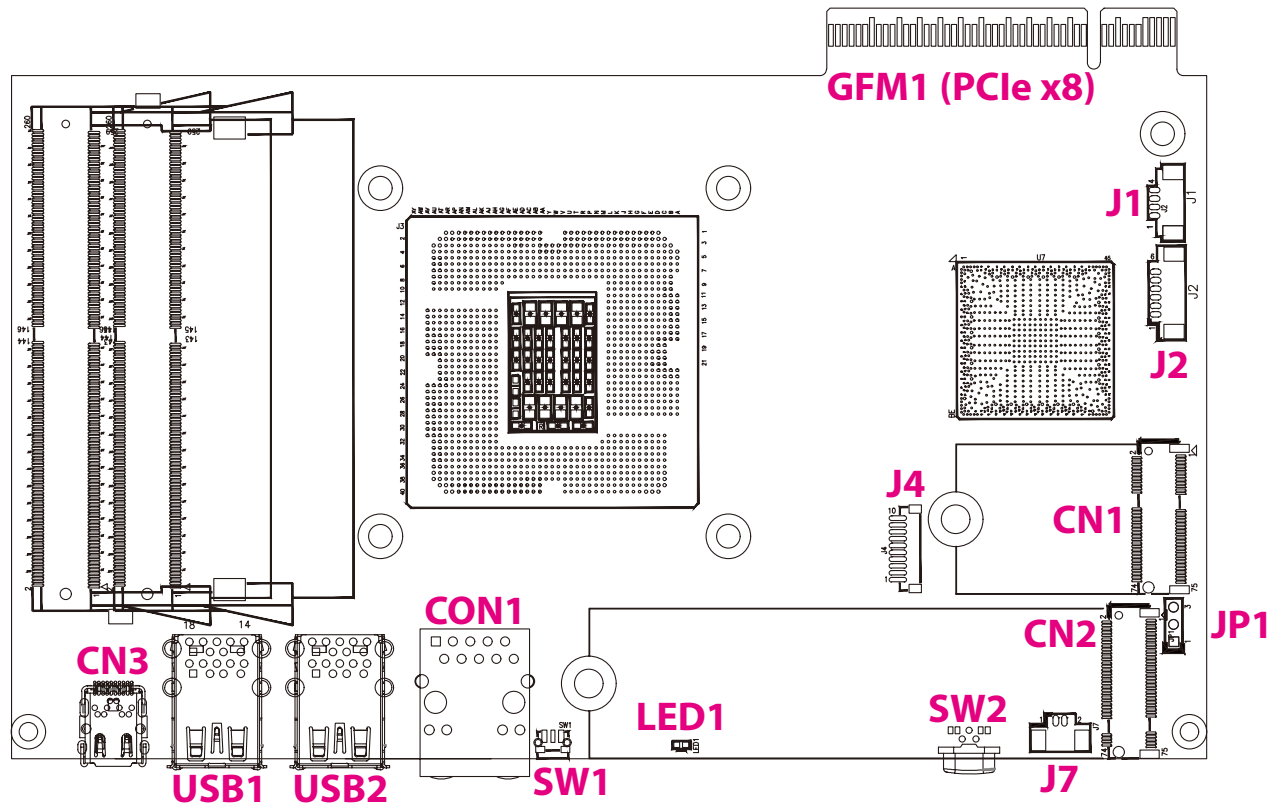

Jumper Settings

A jumper is the simplest kind of electric switch. It consists of two metal pins and a cap. When setting the jumpers, ensure that the jumper caps are placed on the correct pins. When the jumper cap is placed on both pins, the jumper is short. If you remove the jumper cap, or place the jumper cap on just one pin, the jumper is open.

Refer to the illustrations below for examples of what the 2-pin and 3-pin jumpers look like when they are short (on) and open (off).

Two-Pin Jumpers: Open (Left) and Short (Right)

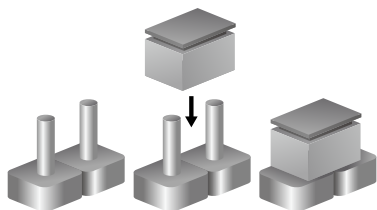

Three-Pin Jumpers: Pins 1 and 2 are Short

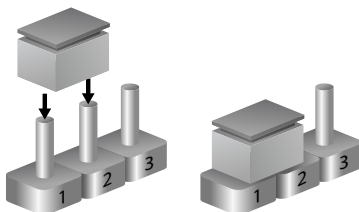

Jumpers

RTC Clear

Connector type: 1x3 3-pin header, 2.54mm pitch

Connector location: JP1



Pin	Settings
1-2 On	Normal
2-3 On	Clear CMOS

1-2 On: default

Connector Pin Definitions

External I/O Interfaces

Power Switch

Connector location: SW2



Pin	Definition
1	GND
2	PWRBTN#

System Reset Switch

Connector location: SW1



Pin	Definition
1-2	System Reset

LAN Connector

Connector type: RJ45 port with LEDs

Connector location: CON1

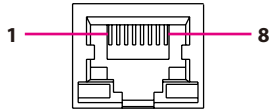

Pin	Definition	Pin	Definition
1	TCT	2	TD4-
3	TD4+	4	TD3-
5	TD3+	6	TD2-
7	TD2+-	8	TD1-
9	TD1+-	10	TCTG
11	LED_Y+	12	LED_Y-
13	LED_O-	14	LED_G-
NH1	NH1	NH2	NH2
MH1	MH1	MH2	MH2
Left-LED: Link/Active:Green		Right-LED: 1G/100:Green/Orange	

USB 3.0 Connectors

Connector type: USB 3.0 port, Type A

Connector location: USB1 and USB2

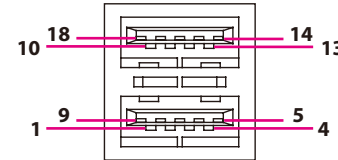

Pin	Definition	Pin	Definition
1	VCC	2	USB0_N
3	USB0_P	4	GND
5	USB3_RX0_N	6	USB3_RX0_P
7	GND	8	USB3_TX0_N
9	USB3_TX0_P	10	VCC
11	USB1_N	12	USB1_P
13	GND	14	USB3_RX1_N
15	USB3_RX1_P	16	GND
17	USB3_TX1_N	18	USB3_TX1_P

Mini DisplayPort Connector

Connector type: Mini DisplayPort

Connector location: CN3

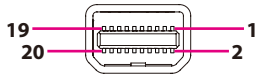

Pin	Definition	Pin	Definition
1	GND	2	DP_HPD
3	DPC_LANE0_P	4	NA
5	DPC_LANE0_N	6	DP_CONFIG2
7	GND	8	GND
9	DPC_LANE1_P	10	DPC_LANE3_P
11	DPC_LANE1_N	12	DPC_LANE3_N
13	GND	14	GND
15	DPC_LANE2_P	16	DPC_AUXP_C
17	DPC_LANE2_N	18	DPC_AUXN_C
19	GND	20	DP1_PWR_C
NH1	NH1	NH2	NH2
MH1	MH1	MH2	MH2
MH3	MH3	MH4	MH4

LED

Connector location: LED1



LED	LED Definition
HDD	Yellow

PCIe x8 Connector (Gold Finger)

Connector type: PCIe x8 Gold Finger

Connector location: GFM1

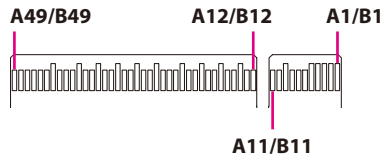

Pin	Definition	Pin	Definition
A1	+12V_SW	B1	+12V_SW
A2	+12V_SW	B2	+12V_SW
A3	+12V_SW	B3	+3VSB_DSW
A4	GND	B4	GND
A5	GND	B5	GND
A6	PWRGD#	B6	PWRBTN#_IN
A7	SLP_S4	B7	RESET#
A8	SDM_DET#	B8	SYAFAN
A9	CEC	B9	GND
A10	I2C0_SDA_ROM	B10	I2C1_SDA
A11	I2C0_SCL_ROM	B11	I2C1_SCL
A12	GSPI0_CLK	B12	GSPI0_MOSI
A13	GSPI0_CS_N	B13	GSPI0_MISO
A14	GND	B14	GND
A15	PCIe_TX+	B15	COM1_TXD
A16	PCIe_TX-	B16	COM1_RXD

Pin	Definition	Pin	Definition
A17	GND	B17	GND
A18	PCIe_RX+	B18	USB3TX_P
A19	PCIe_RX-	B19	USB3TX_N
A20	GND	B20	GND
A21	PCIe_Clk+	B21	USB3RX_P
A22	PCIe_Clk-	B22	USB3RX_N
A23	GND	B23	GND
A24	PCIE_WAKE#	B24	USB2P
A25	PCIE_CLKREQ#	B25	USB2N
A26	PCIE_RST#	B26	USB_OC
A27	GND	B27	GND
A28	TMDS_CLK-	B28	DP3-
A29	TMDS_CLK+	B29	DP3+
A30	GND	B30	GND
A31	TMDS0-	B31	DP2-
A32	TMDS0+	B32	DP2+

Pin	Definition	Pin	Definition
A33	GND	B33	GND
A34	TMDS1-	B34	DP1-
A35	TMDS1+	B35	DP1+
A36	GND	B36	GND
A37	TMDS2-	B37	DPO-
A38	TMDS2+	B38	DPO+
A39	GND	B39	GND
A40	HDMI2_SDA	B40	DP_AUX-
A41	HDMI2_SCL	B41	DP_AUX+
A42	HDMI2_HPD	B42	DP_HPD
A43	GND	B43	GND
A44	NA	B44	NA
A45	NA	B45	NA
A46	NA	B46	NA
A47	NA	B47	NA
A48	NA	B48	NA
A49	NA	B49	NA

Internal Connectors

USB Connector

Connector type: 1x6 6-pin header, 1.25mm pitch

Connector location: J2

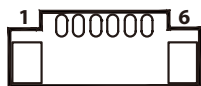

Pin	Definition	Pin	Definition
1	VCC	2	USB_N
3	USB_P	4	USB_N
5	USB_P	6	GND

Debug 80 Port Connector

Connector type: 1x10 10-pin header, 1.0mm pitch

Connector location: J4



Pin	Definition	Pin	Definition
1	GND	2	PCIRST#
3	33M_CLK	4	LPC_FRAME#
5	LPC_AD3	6	LPC_AD2
7	LPC_AD1	8	LPC_AD0
9	3.3V	10	3.3V

RTC Battery Connector

Connector type: 1x2 2-pin header, 1.25mm pitch

Connector location: J7

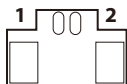

Pin	Definition
1	GND
2	3V

Fan Connector

Connector type: 1x4 4-pin header, 1.25mm pitch

Connector location: J1

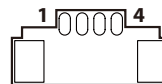

Pin	Definition	Pin	Definition
1	GND	2	VCC
3	SPEED	4	CONTROL

M.2 E Key Connector

Connector location: CN1

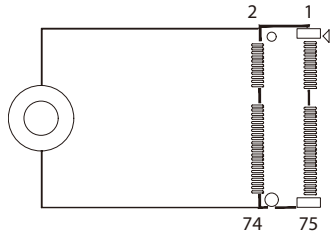

Pin	Definition	Pin	Definition
1	GND	2	3.3VSB
3	USB_D+	4	3.3VSB
5	USB_D-	6	LED1#
7	GND	8	PCM_CLK
9	SDIO_CLK	10	PCM_SYNC
11	SDIO_CMD	12	PCM_IN
13	SDIO_DATA0	14	PCM_OUT
15	SDIO_DATA1	16	LED2#
17	SDIO_DATA2	18	GND
19	SDIO_DATA3	20	UART_WAKE#
21	SDIO_WAKE#	22	UART_RXD
23	SDIO_RESET#	24	
25		26	
27		28	
29		30	
31		32	UART_TXD
33	GND	34	UART_CTS
35	PETP0	36	UART_RTS
37	PETN0	38	RESERVED

Pin	Definition	Pin	Definition
39	GND	40	RESERVED
41	PERP0	42	RESERVED
43	PERN0	44	COEX
45	GND	46	COEX
47	REFCLKP0	48	COEX
49	REFCLKN0	50	SUSCLK
51	GND	52	PERST0#
53	CLKREQ0#	54	W_DISABLE2#
55	PEWAKE0#	56	W_DISABLE1#
57	GND	58	I2C_DATA
59	PETP1	60	I2C_CLK
61	PETN1	62	ALERT#
63	GND	64	RESERVED
65	PERP1	66	UIM_SWP
67	PERN1	68	UIM_POWER_SNK
69	GND	70	UIM_POWER_SRC
71	PEFCLKP1	72	3.3VSB
73	PEFCLKN1	74	3.3VSB
75	GND		

M.2 M Key Connector

Connector location: CN2



Pin	Definition	Pin	Definition
1	GND	2	3.3VSB
3	GND	4	3.3VSB
5	PERN3	6	NC
7	PERP3	8	NC
9	GND	10	DAS/DSS#
11	PETN3	12	3.3VSB
13	PETP3	14	3.3VSB
15	GND	16	3.3VSB
17	PERN2	18	3.3VSB
19	PERP2	20	NC
21	GND	22	NC
23	PETN2	24	NC
25	PETP2	26	NC
27	GND	28	NC
29	PERN1	30	NC
31	PERP1	32	NC
33	GND	34	NC
35	PETN1	36	NC
37	PETP1	38	DEVSLP

Pin	Definition	Pin	Definition
39	GND	40	NC
41	PERNO/SATA_B+	42	NC
43	PERPO/SATA_B-	44	NC
45	GND	46	NC
47	RETNO/SATA_A-	48	NC
49	PETPO/SATA_A+	50	PERST*/NC
51	GND	52	CLKREQ*/NC
53	REFCLKN	54	PEWAKE*/NC
55	REFCLKP	56	NC
57	GND	58	NC
59		60	
61		62	
63		64	
65		66	
67	NC	68	SUSCLK(32KHz)
69	PEDET	70	3.3VSB
71	GND	72	3.3VSB
73	GND	74	3.3VSB
75	GND		

CHAPTER 3: SYSTEM SETUP

Installing the CPU (Socket Type)

1. Loosen the 4 screws on the top side of the CPU bracket and remove the CPU socket cover to access the CPU.
2. Insert the CPU into the socket. The alignment key on the CPU must align with the corner of the CPU socket shown on the photo.

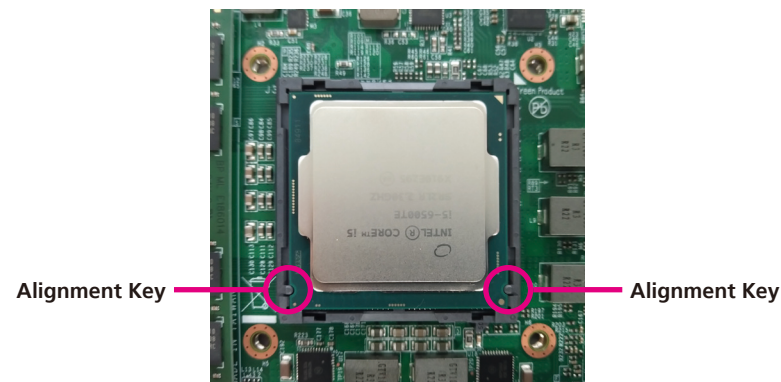
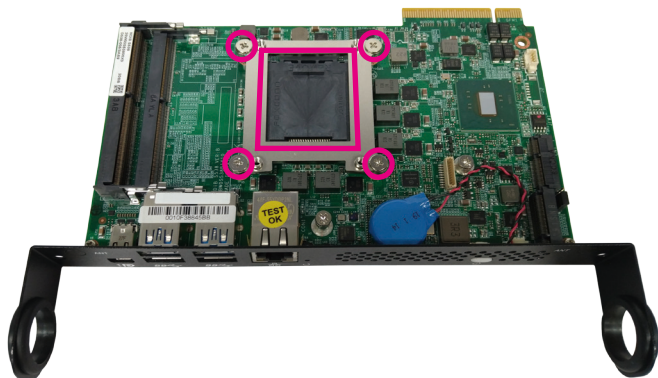

- Handle the CPU by its edges and avoid touching the pins.
- The CPU will fit in only one orientation and can easily be inserted without exerting any force.

3. Reinstall the CPU bracket. Please note that the direction of the bracket notch is facing towards the front IO.

Remove the adhesive film on the thermal pad and place it onto the CPU.



Please install the thermal pad and make sure the adhesive film on the thermal pad is removed before placing it on the heat sink.

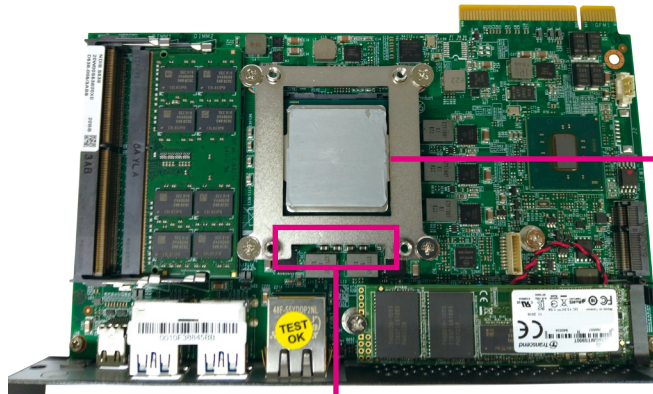

Bracket Notch

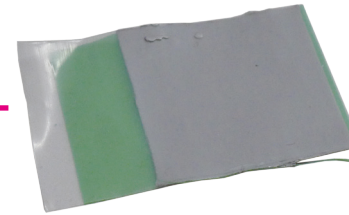

Thermal Pad

Installing a SO-DIMM Memory Module

1. There are two SO-DIMM sockets on the top side of NDiS S538. Install a memory module in the SO-DIMM socket.

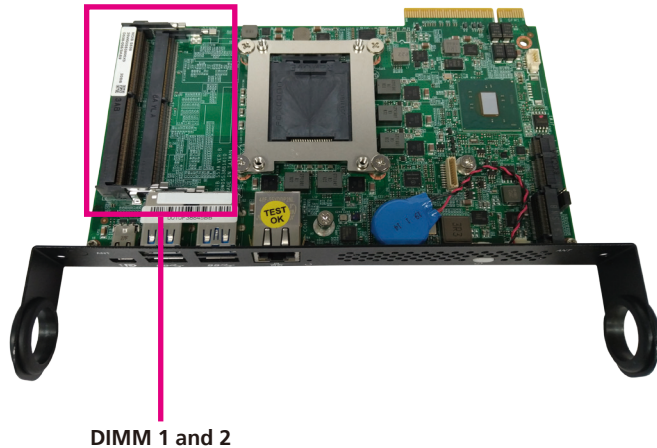

2. Push the ejector tabs which are at the ends of the socket outward. This indicates that the socket is unlocked.

Note how the module is keyed to the socket. Grasping the module by its edges, align the module with the socket so that the “notch” on the module is aligned with the “key” on the socket. The key ensures the module can be plugged into the socket in only one direction.

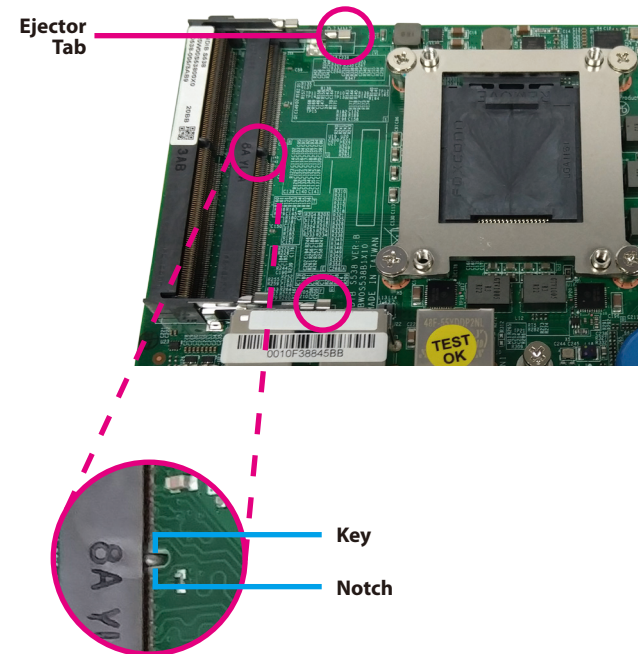

3. Insert the module into the socket at an approximately 30 degree angle. Apply firm even pressure to each end of the module until it slips down into the socket. The contact fingers on the edge of the module will almost completely disappear inside the socket.

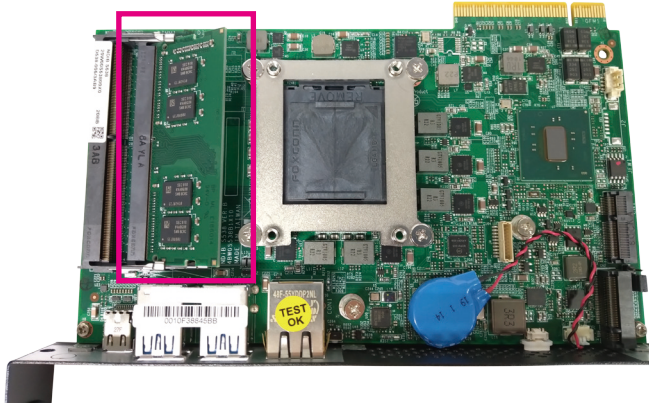

4. The ejector tabs at the ends of the socket will automatically snap into the locked position to hold the module in place.

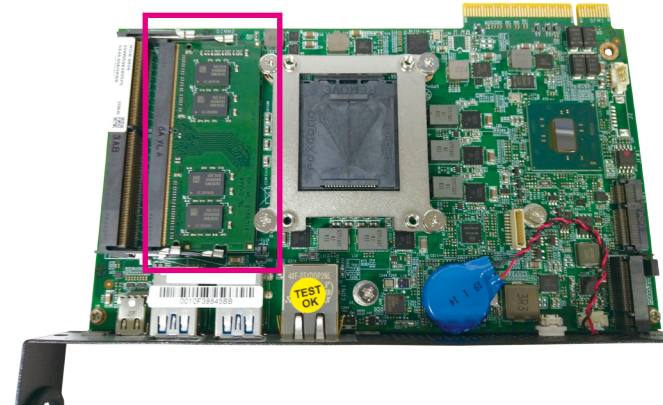

Installing an M.2 SSD Storage Module

The system is equipped with an M.2 M Key connector. To install an M.2 SSD 2280 module, please follow the instructions below.

1. At the bottom of the system, loosen the screws on the bottom cover, then remove the cover from the chassis.
2. Insert the M.2 SSD module into the M.2 slot at a 45 degree angle until the gold-plated connector on the edge of the module completely disappears inside the slot.

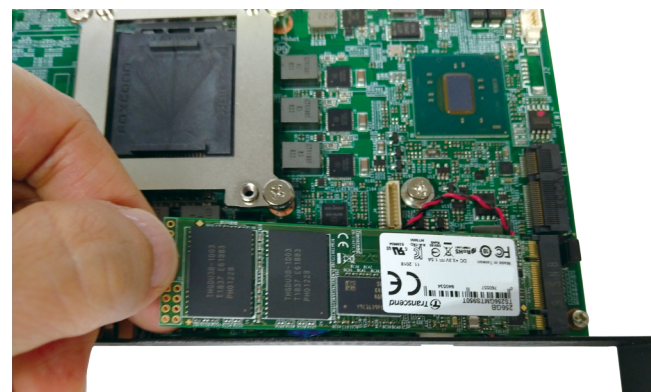
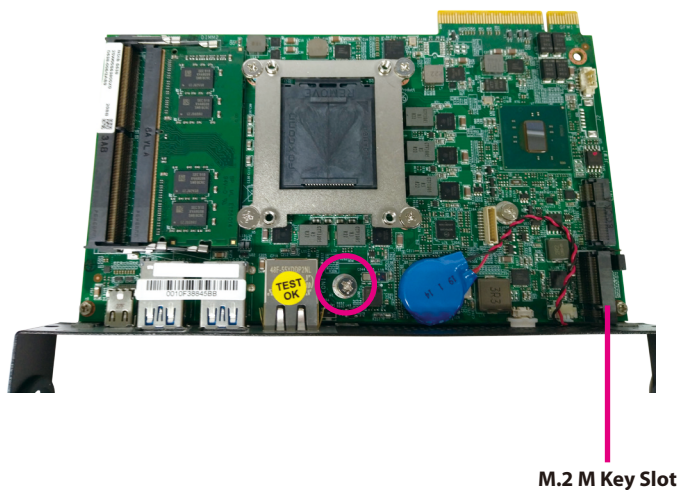

3. With the module fully inserted, tighten a screw into the mounting hole on the module to secure it.

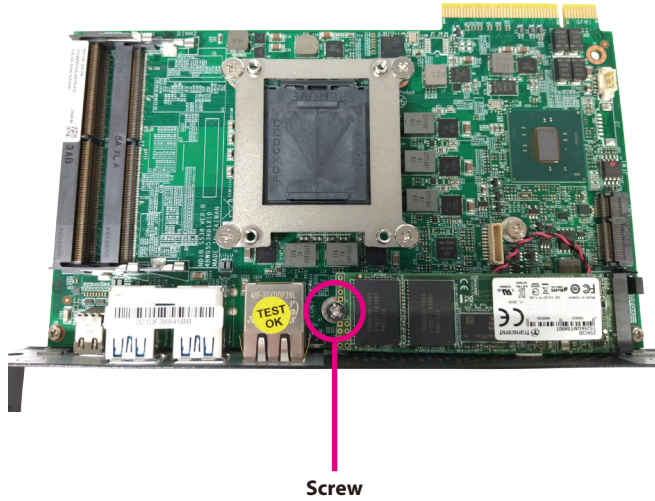

Installing a Wireless LAN Module

The system is equipped with an M.2 E Key connector. To install an M.2 Wireless LAN module, please follow the instructions below.

1. Locate the M.2 E key slot on the mainboard and remove the mounting screw.
2. Insert the Wi-Fi module into the M.2 E key slot at a 45 degree angle until the gold-plated connector on the edge of the module completely disappears inside the slot.

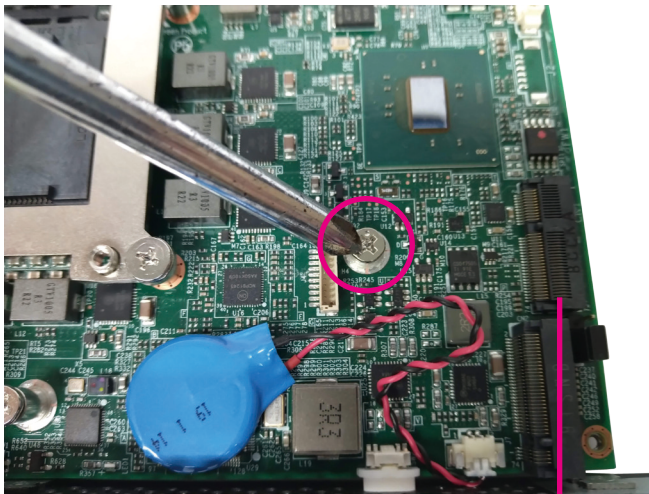

M.2 E Key Slot

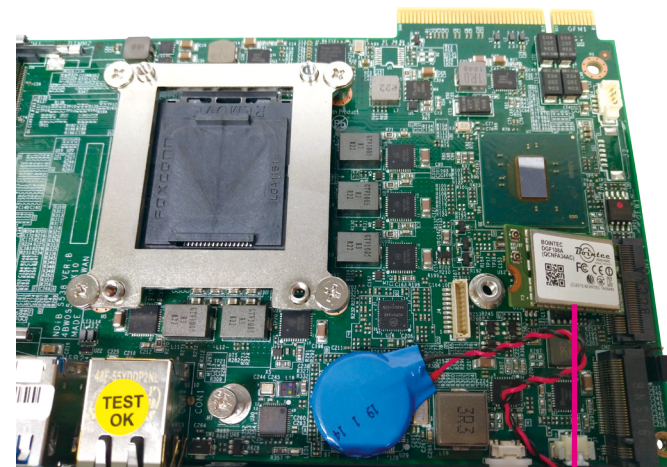

Wi-Fi Module

3. With the module fully inserted, tighten a screw into the mounting hole on the module to secure it.

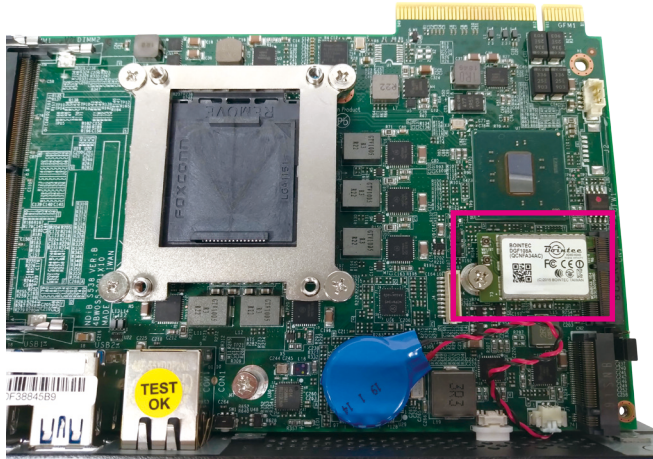

4. Attach the RF cables onto the Wi-Fi module and insert the antenna jack end of the cable through the antenna hole.

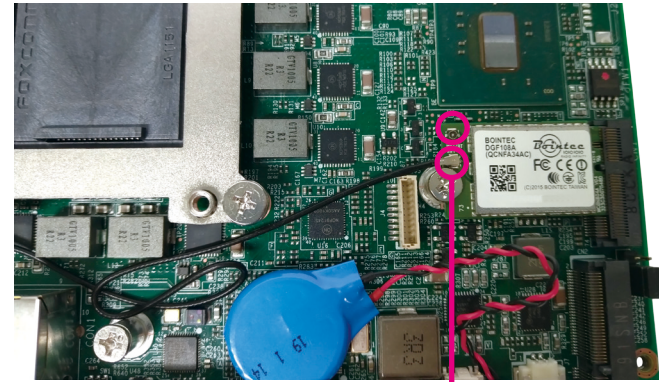

RF Cable



Note:
Please remove the two antenna holes before installing the antenna jack.



Antenna Hole

Antenna Hole

5. Insert the 2 rings (ring 1 then ring 2) into the Wi-Fi antenna jacks.



6. Connect the external antennas to the Wi-Fi antenna jacks.

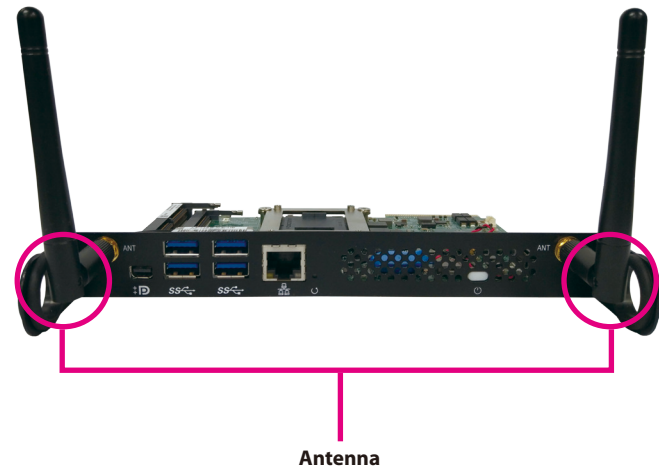

Installing the CPU Cooler

1. Plug the connector on the CPU cooler to the CPU cooler power connector on the mainboard.

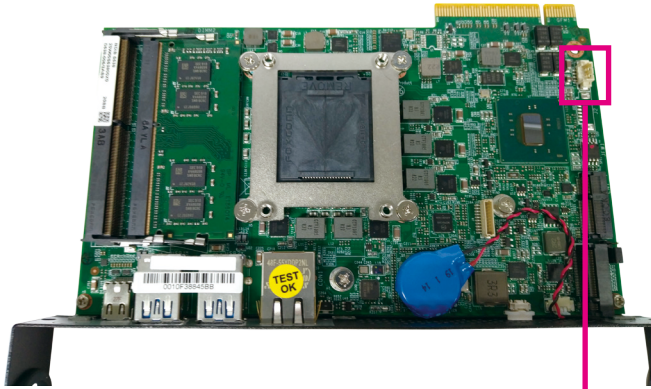

CPU Fan Power Connector



2. Place the CPU cooler on top of the CPU and tighten 4 screws.

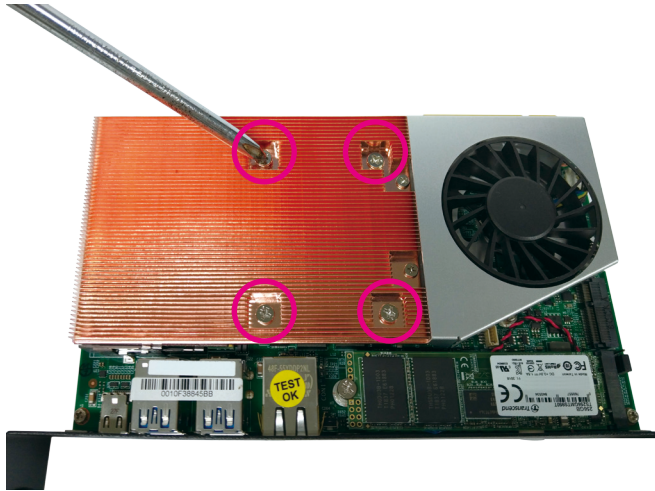

3. Turn to the bottom of the mainboard and tighten a screw.

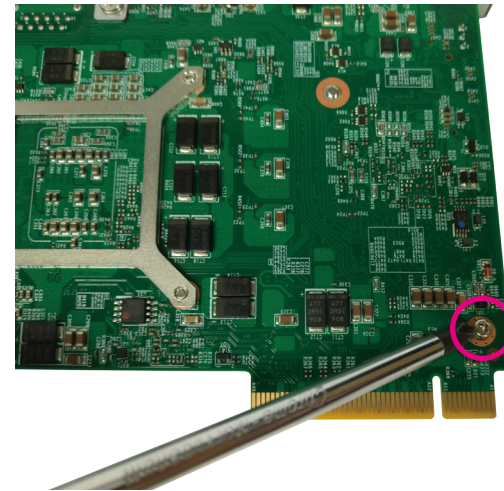

CHAPTER 4: BIOS SETUP

This chapter describes how to use the BIOS setup program for NDiS S538. The BIOS screens provided in this chapter are for reference only and may change if the BIOS is updated in the future.

To check for the latest updates and revisions, visit the NEXCOM website at www.nexcom.com.tw.

About BIOS Setup

The BIOS (Basic Input and Output System) Setup program is a menu driven utility that enables you to make changes to the system configuration and tailor your system to suit your individual work needs. It is a ROM-based configuration utility that displays the system's configuration status and provides you with a tool to set system parameters.

These parameters are stored in non-volatile battery-backed-up CMOS RAM that saves this information even when the power is turned off. When the system is turned back on, the system is configured with the values found in CMOS.

With easy-to-use pull down menus, you can configure such items as:

- Hard drives, diskette drives, and peripherals
- Video display type and display options
- Password protection from unauthorized use
- Power management features

The settings made in the setup program affect how the computer performs. It is important, therefore, first to try to understand all the setup options, and second, to make settings appropriate for the way you use the computer.

When to Configure the BIOS

- This program should be executed under the following conditions:
 - When changing the system configuration
 - When a configuration error is detected by the system and you are prompted to make changes to the setup program
 - When resetting the system clock
 - When redefining the communication ports to prevent any conflicts
 - When making changes to the Power Management configuration
 - When changing the password or making other changes to the security setup

Normally, CMOS setup is needed when the system hardware is not consistent with the information contained in the CMOS RAM, whenever the CMOS RAM has lost power, or the system features need to be changed.

Default Configuration

Most of the configuration settings are either predefined according to the Load Optimal Defaults settings which are stored in the BIOS or are automatically detected and configured without requiring any actions. There are a few settings that you may need to change depending on your system configuration.

Entering Setup











When the system is powered on, the BIOS will enter the Power-On Self Test (POST) routines. These routines perform various diagnostic checks; if an error is encountered, the error will be reported in one of two different ways:

- If the error occurs before the display device is initialized, a series of beeps will be transmitted.
- If the error occurs after the display device is initialized, the screen will display the error message.

Powering on the computer and immediately pressing allows you to enter Setup.

Press the  key to enter Setup:

Legends

Key	Function
	Moves the highlight left or right to select a menu.
	Moves the highlight up or down between sub-menus or fields.
	Exits the BIOS Setup Utility.
	Scrolls forward through the values or options of the highlighted field.
	Scrolls backward through the values or options of the highlighted field.
	Selects a field.
	Displays General Help.
	Load previous values.
	Load optimized default values.
	Saves and exits the Setup program.
	Press <Enter> to enter the highlighted sub-menu

Scroll Bar

When a scroll bar appears to the right of the setup screen, it indicates that there are more available fields not shown on the screen. Use the up and down arrow keys to scroll through all the available fields.

Submenu

When “▶” appears on the left of a particular field, it indicates that a submenu which contains additional options are available for that field. To display the submenu, move the highlight to that field and press  .

BIOS Setup Utility

Once you enter the AMI BIOS Setup Utility, the Main Menu will appear on the screen. The main menu allows you to select from several setup functions and one exit. Use arrow keys to select among the items and press  to accept or enter the submenu.

Main

The Main menu is the first screen that you will see when you enter the BIOS Setup Utility.

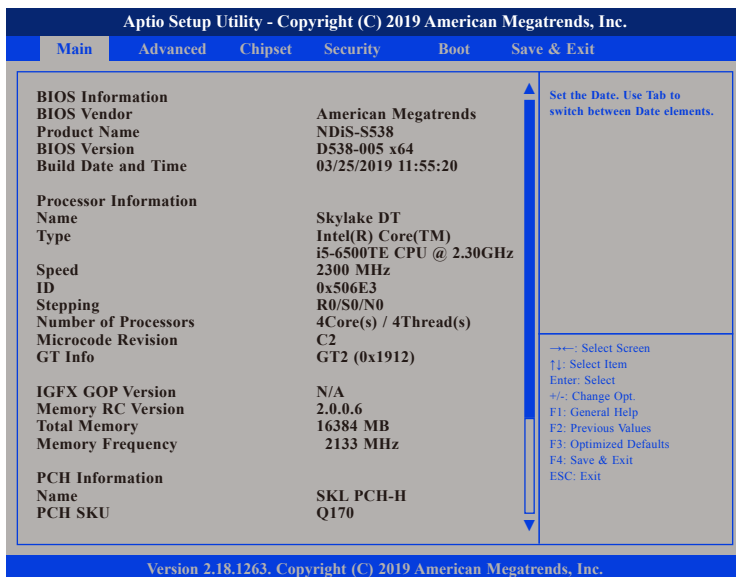

Aptio Setup Utility - Copyright (C) 2019 American Megatrends, Inc.					
Main	Advanced	Chipset	Security	Boot	Save & Exit
BIOS Information					
BIOS Vendor	American Megatrends				
Product Name	NDiS-S538				
BIOS Version	D538-005 x64				
Build Date and Time	03/25/2019 11:55:20				
Processor Information					
Name	Skylake DT				
Type	Intel(R) Core(TM) i5-6500TE CPU @ 2.30GHz				
Speed	2300 MHz				
ID	0x506E3				
Stepping	R0/S0/N0				
Number of Processors	4Core(s) / 4Thread(s)				
Microcode Revision	C2				
GT Info	GT2 (0x1912)				
IGFX GOP Version					
IGFX GOP Version	N/A				
Memory RC Version	2.0.0.6				
Total Memory	16384 MB				
Memory Frequency	2133 MHz				
PCH Information					
Name	SKL PCH-H				
PCH SKU	Q170				

←→: Select Screen
 ↑↓: Select Item
 Enter: Select
 +/-: Change Opt.
 F1: General Help
 F2: Previous Values
 F3: Optimized Defaults
 F4: Save & Exit
 ESC: Exit

Version 2.18.1263. Copyright (C) 2019 American Megatrends, Inc.

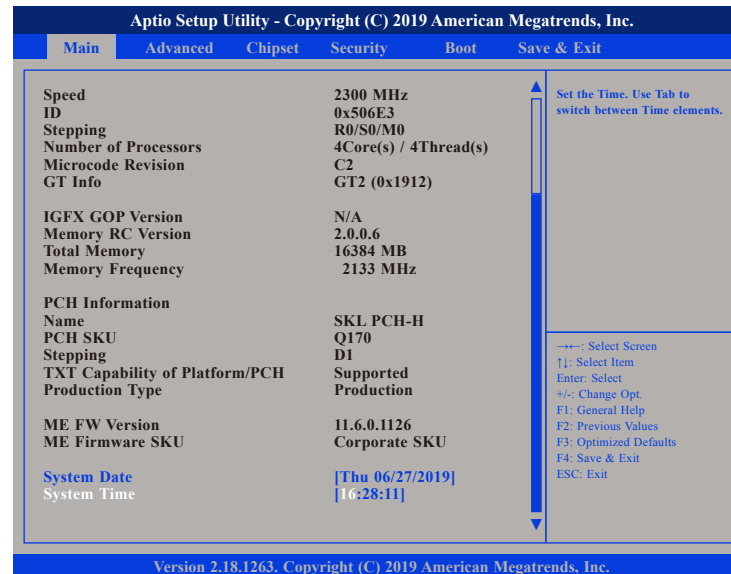

Aptio Setup Utility - Copyright (C) 2019 American Megatrends, Inc.					
Main	Advanced	Chipset	Security	Boot	Save & Exit
Speed	2300 MHz				
ID	0x506E3				
Stepping	R0/S0/M0				
Number of Processors	4Core(s) / 4Thread(s)				
Microcode Revision	C2				
GT Info	GT2 (0x1912)				
IGFX GOP Version					
IGFX GOP Version	N/A				
Memory RC Version	2.0.0.6				
Total Memory	16384 MB				
Memory Frequency	2133 MHz				
PCH Information					
Name	SKL PCH-H				
PCH SKU	Q170				
Stepping	D1				
TXT Capability of Platform/PCH	Supported				
Production Type	Production				
ME FW Version					
ME FW Version	11.6.0.1126				
ME Firmware SKU	Corporate SKU				
System Date					
System Date	[Thu 06/27/2019]				
System Time	[16:28:11]				

←→: Select Screen
 ↑↓: Select Item
 Enter: Select
 +/-: Change Opt.
 F1: General Help
 F2: Previous Values
 F3: Optimized Defaults
 F4: Save & Exit
 ESC: Exit

Version 2.18.1263. Copyright (C) 2019 American Megatrends, Inc.

System Date

The date format is <day>, <month>, <date>, <year>. Day displays a day, from Monday to Sunday. Month displays the month, from January to December. Date displays the date, from 1 to 31. Year displays the year, from 1999 to 2099.

System Time

The time format is <hour>, <minute>, <second>. The time is based on the 24-hour military-time clock. For example, 1 p.m. is 13:00:00. Hour displays hours from 00 to 23. Minute displays minutes from 00 to 59. Second displays seconds from 00 to 59.

Advanced

The Advanced menu allows you to configure your system for basic operation. Some entries are defaults required by the system board, while others, if enabled, will improve the performance of your system or let you set some features according to your preference.



Setting incorrect field values may cause the system to malfunction.



State After G3

Configures the power state when power is re-applied after a power failure (G3 state).

CPU Configuration

This section is used to view CPU status and configure CPU parameters.

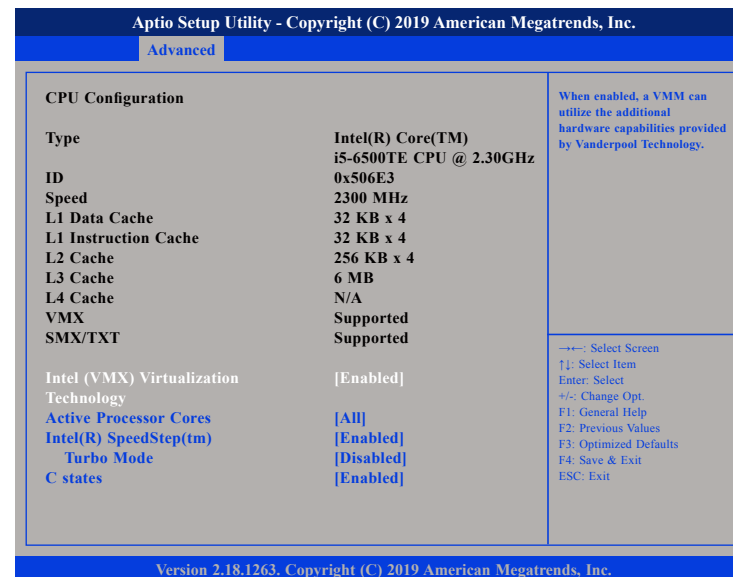

Intel® (VMX) Virtualization Technology

When this field is set to Enabled, the VMM can utilize the additional hardware capabilities provided by Vanderpool Technology.

Active Processor Cores

Select the number of cores to enable in each processor package.

Intel® SpeedStep™

Enables or disables Intel SpeedStep.

Turbo Mode

Enables or disables turbo mode.

CPU C States

Enables or disables CPU C states.

SATA Configuration

This section is used to configure the SATA device option settings.



Port 0

Enables or disables SATA port 0.

Hot Plug

Enables or disables hot plugging feature on SATA port 0.

SATA Mode Selection

Configures the SATA as AHCI mode.

AHCI This option configures the Serial ATA drives to use AHCI (Advanced Host Controller Interface). AHCI allows the storage driver to enable the advanced Serial ATA features which will increase storage performance.

SATA Test Mode

Enables or disables SATA test mode.

AMT Configuration

This section is used to configure AMT settings.



AMT BIOS Features

When disabled AMT BIOS Features are no longer supported and user is no longer able to access MEBx Setup. Please note that this option does not disable Manageability Features in FW.

MEBx hotkey Pressed

Enables or disables automatic MEBx hotkey press.

MEBx Selection Screen

Enables or disables MEBx selection screen.

ACPI Settings

This section is used to configure ACPI settings.

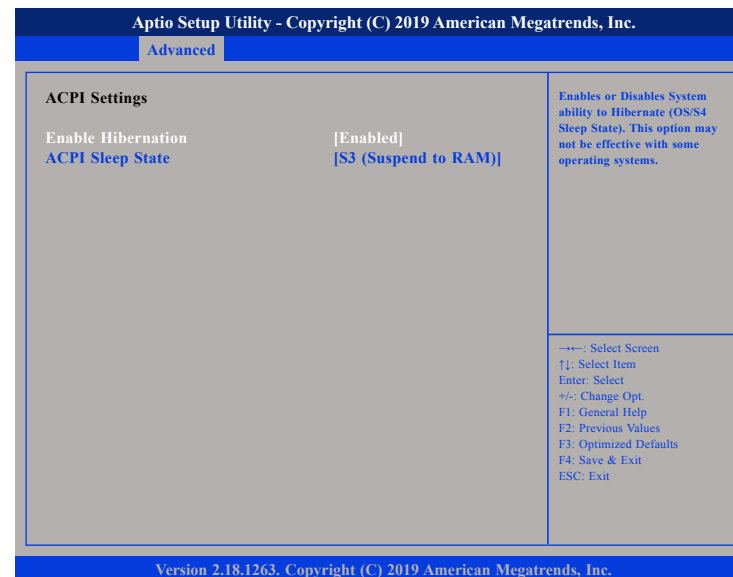

Enable Hibernation

Enables or disables system ability to hibernate (OS/S4 Sleep State). This option may not be effective with some operating systems.

ACPI Sleep State

Select the highest ACPI sleep state the system will enter when the suspend button is pressed. The options are Suspend Disabled and S3 (Suspend to RAM).

NCT6106D Super IO Configuration

This section is used to configure the rear serial ports.

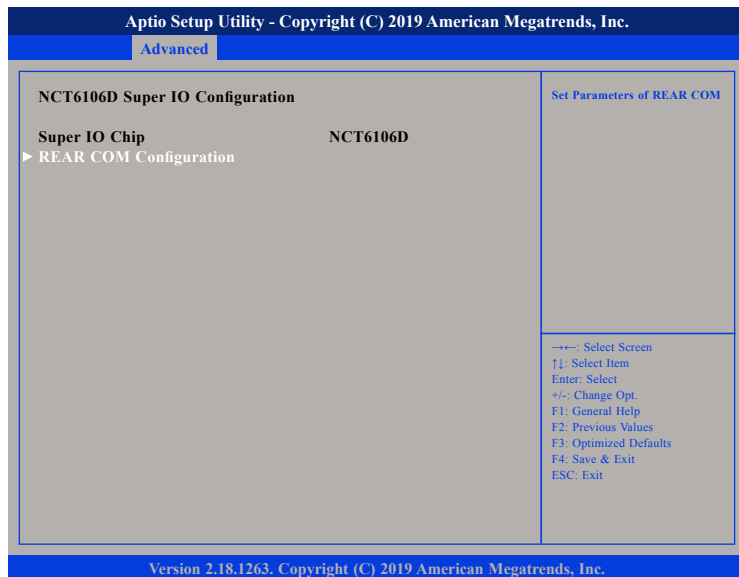

Super IO Chip

Displays the Super I/O chip used on the board.

REAR COM Configuration



Serial Port

Enables or disables the rear serial COM port.

Device Settings

Displays the IO address and IRQ of the rear serial COM port.

NCT6106D HW Monitor

This section is used to monitor hardware status such as temperature, fan speed and voltages.



The screenshot shows the 'Advanced' tab of the Aptio Setup Utility. The 'Pe Health Status' section is expanded, displaying the following settings:

Pe Health Status		Enable or Disable Smart Fan
Smart Fan Function	[Enabled]	
Cpu Fan Mode	[Thermal Cruise™ Mode]	
CpuFan Target Temp	55	
CpuFan Tolerance	5	
CPU temperature	: +34 °c	
CPU FAN Speed	: 3600 RPM	
System Fan Mode	[Enable]	
VCORE	: +0.952 V	
VCC5	: +5.080 V	
VCC3	: +3.328 V	

Navigation instructions are listed in the bottom right corner:

- ←: Select Screen
- ↑↓: Select Item
- Enter: Select
- +/-: Change Opt.
- F1: General Help
- F2: Previous Values
- F3: Optimized Defaults
- F4: Save & Exit
- ESC: Exit

Version 2.18.1263. Copyright (C) 2019 American Megatrends, Inc.

Smart Fan Function

Enables or disables the smart fan function.

Cpu Fan Mode

Configures the fan mode of the CPU fan. The options are Thermal Cruise Mode (automatic fan mode), Fan Speed Cruise Mode and SmartFan III Mode.

CpuFan Target Temp

Displays the temperature threshold to activate smart fan.

CpuFan Tolerance

Displays the tolerance value for increasing and decreasing the fan speed. The fan speed will increase when the CPU temperature reaches the value in CpuFan Target Temp plus the value in CpuFan Tolerance. The fan speed will decrease when the CPU temperature is below the CpuFan Target Temp minus the value in CpuFan Tolerance.

System Fan Mode

Configures the operating mode of the system fan.

S5 RTC Wake Settings

This section is used to configure system to wake from S5 using RTC alarm.

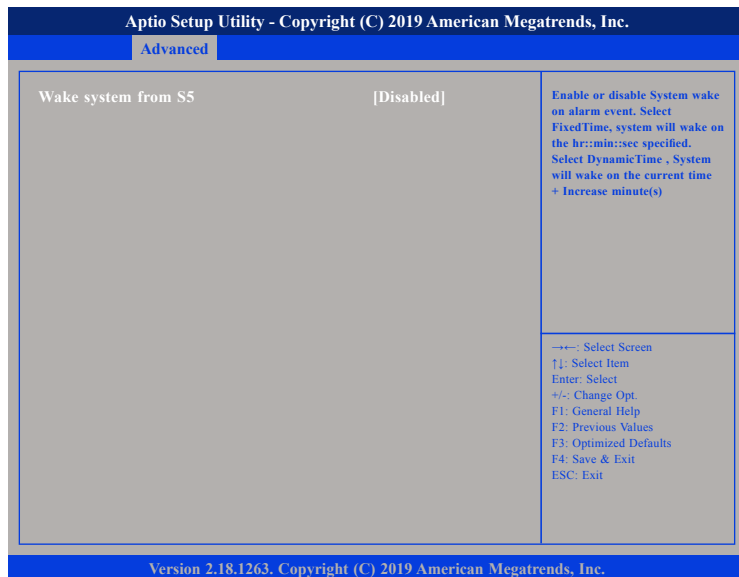

Wake System from S5

Enables or disables system wake on alarm event. When FixedTime is selected, system will wake on the hr::min::sec specified. When DynamicTime is selected, system will wake on the current time + Increase minute(s).

CSM Configuration

This section is used to configure the compatibility support module features.

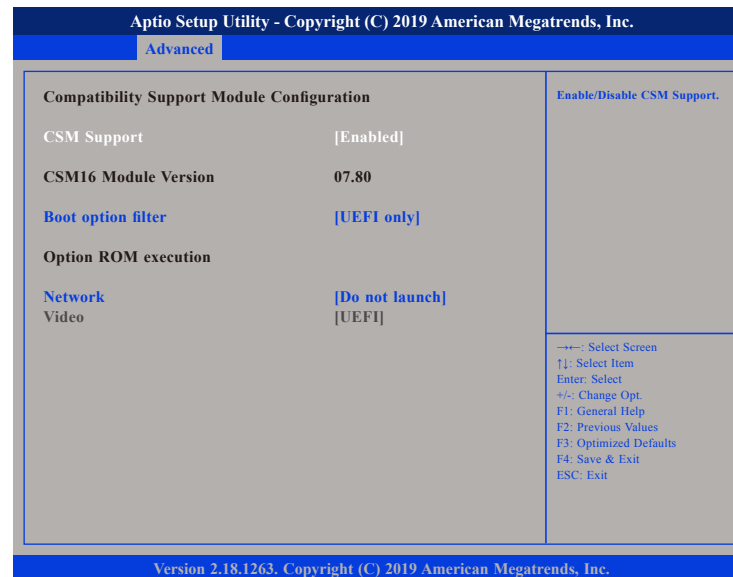

CSM Support

Enables or disables Compatibility Support Module (CSM).

Boot Option Filter

This option filters which devices the system can boot to.

Network

Enables or disables the boot option for legacy network devices.

NVMe Configuration

This section is used to display information on the NVMe devices installed.

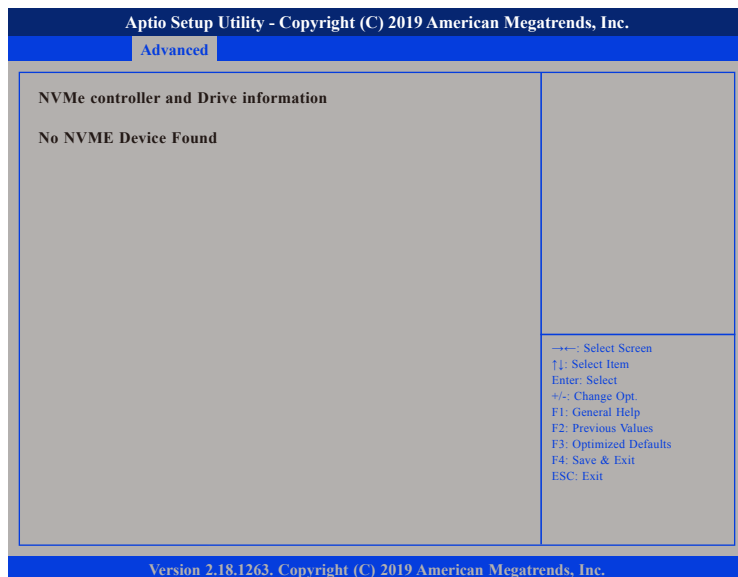

USB Configuration

This section is used to configure USB parameters.

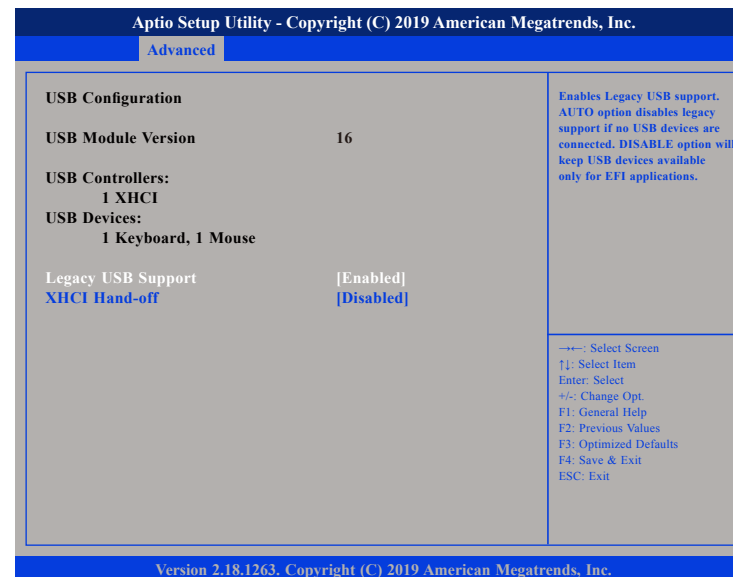

Legacy USB Support

Enabled Enables Legacy USB.

Auto Disables support for Legacy when no USB devices are connected.

Disabled Keeps USB devices available only for EFI applications.

XHCI Hand-off

This is a workaround for OSs that does not support XHCI hand-off. The XHCI ownership change should be claimed by the XHCI driver.

Chipset

This section gives you functions to configure the system based on the specific features of the chipset. The chipset manages bus speeds and access to system memory resources.



System Agent (SA) Configuration

System Agent (SA) parameters.

System Agent (SA) Configuration

This section is used to configure the System Agent (SA) configuration.

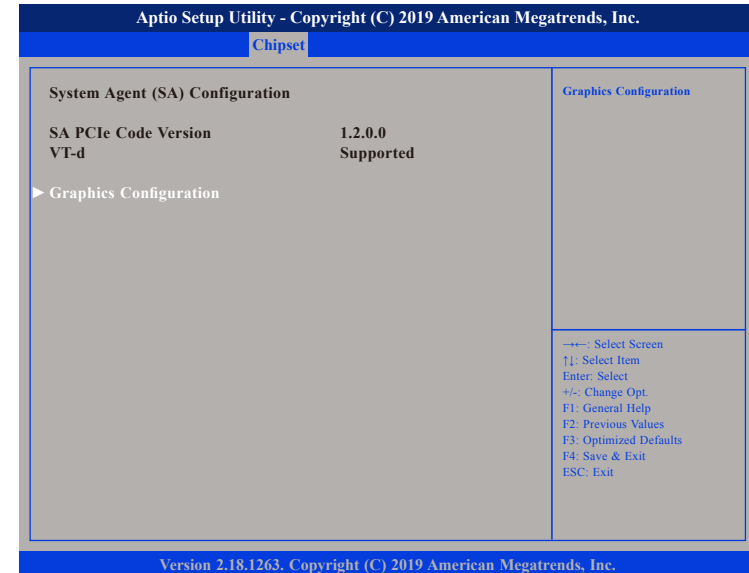

Graphics Configuration

Enters the Graphics Configuration submenu.

Security



Administrator Password

Select this to reconfigure the administrator's password.

User Password

Select this to reconfigure the user's password.

Boot



Bootup NumLock State

This allows you to determine the default state of the numeric keypad. By default, the system boots up with NumLock on wherein the function of the numeric keypad is the number keys. When set to Off, the function of the numeric keypad is the arrow keys.

Boot Option Priorities

This allows you to adjust the boot sequence of the system. Boot Option #1 is the first boot device that the system will boot from, next will be #2 and so forth.

Save & Exit



Save Changes and Reset

To save the changes and restart the system, select this field then press <Enter>. A dialog box will appear. Confirm by selecting Yes. You can also press <F4> to save and exit Setup.

Discard Changes and Reset

To exit the Setup utility without saving the changes and restart the system, select this field then press <Enter>. You may be prompted to confirm again before exiting. You can also press <ESC> to exit without saving the changes.

Restore Defaults

To restore the BIOS to default settings, select this field then press <Enter>. A dialog box will appear. Confirm by selecting Yes.

Boot Override

To bypass the boot sequence from the Boot Option List and boot from a particular device, select the desired device and press <Enter>.

APPENDIX A: NCT6106 WATCHDOG PROGRAMMING GUIDE

NDiS S538 features a watchdog timer that resets the CPU or generates an interrupt if the processor stops operating for any reason. This feature ensures system reliability in industrial standalone or unmanned environments.

```
#define SUPERIO_PORT    0x2E
#define WDT_SET         0xF0
#define WDT_VALUE       0xF1

void main(void)
{
    # Enter SuperIO Configuration
        outputb(SUPERIO_PORT, 0x87);
        outputb(SUPERIO_PORT, 0x87);

    # Set LDN
        outputb(SUPERIO_PORT, 0x07);
        outputb(SUPERIO_PORT+1, 0x08);

    # Set WDT setting
        outputb(SUPERIO_PORT, WDT_SET);
        outputb(SUPERIO_PORT+1, 0x00);           # Use the second
                                                # Use the minute, change value to 0x08

    # Set WDT sec/min
        outputb(SUPERIO_PORT, WDT_VALUE);
        outputb(SUPERIO_PORT+1, 0x05);         # Set 5 seconds
}
```