



**NEXCOM International Co., Ltd.**

# **Interactive Signage Platform**

## **Digital Signage Platform**

### **NDiS B425-SI3**

#### User Manual

# CONTENTS

## Preface

Copyright .....	iv
Disclaimer .....	iv
Acknowledgements .....	iv
Regulatory Compliance Statements .....	iv
Declaration of Conformity .....	iv
RoHS Compliance .....	v
Warranty and RMA .....	vi
Safety Information .....	viii
Installation Recommendations .....	viii
Safety Precautions .....	ix
Technical Support and Assistance .....	x
Conventions Used in this Manual .....	x
Global Service Contact Information .....	xi
Package Contents .....	xiii
Ordering Information .....	xiv

## Chapter 1: Product Introduction

NDiS B425-SI3 .....	1
Overview .....	1
Key Features .....	1
Hardware Specifications .....	2
Knowing Your NDiS B425-SI3 .....	3
Front Panel .....	3
Rear Panel .....	4
Mechanical Dimensions .....	5

## Chapter 2: Jumpers and Connectors

Before You Begin .....	6
Precautions .....	6
Jumper Settings .....	7
Location of the Jumpers and Connectors .....	8
Top View .....	8
Bottom View .....	9
Connector/Button Table .....	10
Header/Wafer Table .....	10

## Chapter 3: System Setup

Installing a SATA HDD .....	11
Installing a SO-DIMM Memory Module .....	13
Installing a NGFF M.2 Wi-Fi Module (Optional) .....	14
Installing Wall Mount Brackets .....	17
Installing the VESA Mount Kit .....	18

## Chapter 4: BIOS Setup

About BIOS Setup .....	19
When to Configure the BIOS .....	19
Default Configuration .....	20
Entering Setup .....	20
Legends .....	20
BIOS Setup Utility .....	22
Main .....	22
Advanced .....	23



Power.....28  
Security .....30  
Boot.....30  
Save & Exit .....32

**Appendix A: Watchdog .....33**

# PREFACE

## Copyright

This publication, including all photographs, illustrations and software, is protected under international copyright laws, with all rights reserved. No part of this manual may be reproduced, copied, translated or transmitted in any form or by any means without the prior written consent from NEXCOM International Co., Ltd.

## Disclaimer

The information in this document is subject to change without prior notice and does not represent commitment from NEXCOM International Co., Ltd. However, users may update their knowledge of any product in use by constantly checking its manual posted on our website: <http://www.nexcom.com>. NEXCOM shall not be liable for direct, indirect, special, incidental, or consequential damages arising out of the use of any product, nor for any infringements upon the rights of third parties, which may result from such use. Any implied warranties of merchantability or fitness for any particular purpose is also disclaimed.

## Acknowledgements

NDiS B425-SI3 is a trademark of NEXCOM International Co., Ltd. All other product names mentioned herein are registered trademarks of their respective owners.

## Regulatory Compliance Statements

This section provides the FCC compliance statement for Class A devices and describes how to keep the system CE compliant.

## Declaration of Conformity

### FCC

This equipment has been tested and verified to comply with the limits for a Class A digital device, pursuant to Part 15 of FCC Rules. These limits are designed to provide reasonable protection against harmful interference when the equipment is operated in a commercial environment. This equipment generates, uses, and can radiate radio frequency energy and, if not installed and used in accordance with the instructions, may cause harmful interference to radio communications. Operation of this equipment in a residential area (domestic environment) is likely to cause harmful interference, in which case the user will be required to correct the interference (take adequate measures) at their own expense.

### CE

The product(s) described in this manual complies with all applicable European Union (CE) directives if it has a CE marking. For computer systems to remain CE compliant, only CE-compliant parts may be used. Maintaining CE compliance also requires proper cable and cabling techniques.

## RoHS Compliance



### **NEXCOM RoHS Environmental Policy and Status Update**

NEXCOM is a global citizen for building the digital infrastructure. We are committed to providing green products and services, which are compliant with European Union RoHS (Restriction on Use of Hazardous Substance in Electronic Equipment) directive 2011/65/EU, to be your trusted green partner and to protect our environment.

RoHS restricts the use of Lead (Pb) < 0.1% or 1,000ppm, Mercury (Hg) < 0.1% or 1,000ppm, Cadmium (Cd) < 0.01% or 100ppm, Hexavalent Chromium (Cr6+) < 0.1% or 1,000ppm, Polybrominated biphenyls (PBB) < 0.1% or 1,000ppm, and Polybrominated diphenyl Ethers (PBDE) < 0.1% or 1,000ppm.

In order to meet the RoHS compliant directives, NEXCOM has established an engineering and manufacturing task force to implement the introduction of green products. The task force will ensure that we follow the standard NEXCOM development procedure and that all the new RoHS components and new manufacturing processes maintain the highest industry quality levels for which NEXCOM are renowned.

The model selection criteria will be based on market demand. Vendors and suppliers will ensure that all designed components will be RoHS compliant.

### **How to recognize NEXCOM RoHS Products?**

For existing products where there are non-RoHS and RoHS versions, the suffix "(LF)" will be added to the compliant product name.

All new product models launched after January 2013 will be RoHS compliant. They will use the usual NEXCOM naming convention.

## Warranty and RMA

### NEXCOM Warranty Period

NEXCOM manufactures products that are new or equivalent to new in accordance with industry standard. NEXCOM warrants that products will be free from defect in material and workmanship for 2 years, beginning on the date of invoice by NEXCOM. HCP series products (Blade Server) which are manufactured by NEXCOM are covered by a three year warranty period.

### NEXCOM Return Merchandise Authorization (RMA)

- Customers shall enclose the “NEXCOM RMA Service Form” with the returned packages.
- Customers must collect all the information about the problems encountered and note anything abnormal or, print out any on-screen messages, and describe the problems on the “NEXCOM RMA Service Form” for the RMA number apply process.
- Customers can send back the faulty products with or without accessories (manuals, cable, etc.) and any components from the card, such as CPU and RAM. If the components were suspected as part of the problems, please note clearly which components are included. Otherwise, NEXCOM is not responsible for the devices/parts.
- Customers are responsible for the safe packaging of defective products, making sure it is durable enough to be resistant against further damage and deterioration during transportation. In case of damages occurred during transportation, the repair is treated as “Out of Warranty.”
- Any products returned by NEXCOM to other locations besides the customers’ site will bear an extra charge and will be billed to the customer.

### Repair Service Charges for Out-of-Warranty Products

NEXCOM will charge for out-of-warranty products in two categories, one is basic diagnostic fee and another is component (product) fee.

### Repair Service Charges for Out-of-Warranty Products

NEXCOM will charge for out-of-warranty products in two categories, one is basic diagnostic fee and another is component (product) fee.

### System Level

- Component fee: NEXCOM will only charge for main components such as SMD chip, BGA chip, etc. Passive components will be repaired for free, ex: resistor, capacitor.
- Items will be replaced with NEXCOM products if the original one cannot be repaired. Ex: motherboard, power supply, etc.
- Replace with 3rd party products if needed.
- If RMA goods can not be repaired, NEXCOM will return it to the customer without any charge.

### Board Level

- Component fee: NEXCOM will only charge for main components, such as SMD chip, BGA chip, etc. Passive components will be repaired for free, ex: resistors, capacitors.
- If RMA goods can not be repaired, NEXCOM will return it to the customer without any charge.

## Warnings

Read and adhere to all warnings, cautions, and notices in this guide and the documentation supplied with the chassis, power supply, and accessory modules. If the instructions for the chassis and power supply are inconsistent with these instructions or the instructions for accessory modules, contact the supplier to find out how you can ensure that your computer meets safety and regulatory requirements.

## Cautions

Electrostatic discharge (ESD) can damage system components. Do the described procedures only at an ESD workstation. If no such station is available, you can provide some ESD protection by wearing an antistatic wrist strap and attaching it to a metal part of the computer chassis.

## Safety Information

Before installing and using the device, note the following precautions:

- Read all instructions carefully.
- Do not place the unit on an unstable surface, cart, or stand.
- Follow all warnings and cautions in this manual.
- When replacing parts, ensure that your service technician uses parts specified by the manufacturer.
- Avoid using the system near water, in direct sunlight, or near a heating device.
- The load of the system unit does not solely rely for support from the rackmounts located on the sides. Firm support from the bottom is highly necessary in order to provide balance stability.
- The computer is provided with a battery-powered real-time clock circuit. There is a danger of explosion if battery is incorrectly replaced. Replace only with the same or equivalent type recommended by the manufacturer. Discard used batteries according to the manufacturer's instructions.

## Installation Recommendations

Ensure you have a stable, clean working environment. Dust and dirt can get into components and cause a malfunction. Use containers to keep small components separated.

Adequate lighting and proper tools can prevent you from accidentally damaging the internal components. Most of the procedures that follow require only a few simple tools, including the following:

- A Philips screwdriver
- A flat-tipped screwdriver
- A grounding strap
- An anti-static pad

Using your fingers can disconnect most of the connections. It is recommended that you do not use needle-nose pliers to disconnect connections as these can damage the soft metal or plastic parts of the connectors.



## Safety Precautions

1. Read these safety instructions carefully.
2. Keep this User Manual for later reference.
3. Disconnect this equipment from any AC outlet before cleaning. Use a damp cloth. Do not use liquid or spray detergents for cleaning.
4. For plug-in equipment, the power outlet socket must be located near the equipment and must be easily accessible.
5. Keep this equipment away from humidity.
6. Put this equipment on a stable surface during installation. Dropping it or letting it fall may cause damage.
7. The openings on the enclosure are for air convection to protect the equipment from overheating. **DO NOT COVER THE OPENINGS.**
8. Make sure the voltage of the power source is correct before connecting the equipment to the power outlet.
9. Place the power cord in a way so that people will not step on it. Do not place anything on top of the power cord. Use a power cord that has been approved for use with the product and that it matches the voltage and current marked on the product's electrical range label. The voltage and current rating of the cord must be greater than the voltage and current rating marked on the product.
10. All cautions and warnings on the equipment should be noted.
11. If the equipment is not used for a long time, disconnect it from the power source to avoid damage by transient overvoltage.
12. Never pour any liquid into an opening. This may cause fire or electrical shock.
13. Never open the equipment. For safety reasons, the equipment should be opened only by qualified service personnel.
14. If one of the following situations arises, get the equipment checked by service personnel:
  - a. The power cord or plug is damaged.
  - b. Liquid has penetrated into the equipment.
  - c. The equipment has been exposed to moisture.
  - d. The equipment does not work well, or you cannot get it to work according to the user's manual.
  - e. The equipment has been dropped and damaged.
  - f. The equipment has obvious signs of breakage.
15. Do not place heavy objects on the equipment.
16. The unit uses a three-wire ground cable which is equipped with a third pin to ground the unit and prevent electric shock. Do not defeat the purpose of this pin. If your outlet does not support this kind of plug, contact your electrician to replace your obsolete outlet.
17. **CAUTION: DANGER OF EXPLOSION IF BATTERY IS INCORRECTLY REPLACED. REPLACE ONLY WITH THE SAME OR EQUIVALENT TYPE RECOMMENDED BY THE MANUFACTURER. DISCARD USED BATTERIES ACCORDING TO THE MANUFACTURER'S INSTRUCTIONS.**

## Technical Support and Assistance

1. For the most updated information of NEXCOM products, visit NEXCOM's website at [www.nexcom.com](http://www.nexcom.com).
2. For technical issues that require contacting our technical support team or sales representative, please have the following information ready before calling:
  - Product name and serial number
  - Detailed information of the peripheral devices
  - Detailed information of the installed software (operating system, version, application software, etc.)
  - A complete description of the problem
  - The exact wordings of the error messages

### Warning!

1. Handling the unit: carry the unit with both hands and handle it with care.
2. Maintenance: to keep the unit clean, use only approved cleaning products or clean with a dry cloth.

## Conventions Used in this Manual



### Warning:

Information about certain situations, which if not observed, can cause personal injury. This will prevent injury to yourself when performing a task.



### Caution:

Information to avoid damaging components or losing data.



### Note:

Provides additional information to complete a task easily.

## Global Service Contact Information

### Headquarters

#### **NEXCOM International Co., Ltd.**

9F, No. 920, Chung-Cheng Rd.,  
ZhongHe District, New Taipei City, 23586,  
Taiwan, R.O.C.

Tel: +886-2-8226-7786

Fax: +886-2-8226-7782

[www.nexcom.com](http://www.nexcom.com)

### America

#### **USA**

#### **NEXCOM USA**

2883 Bayview Drive,  
Fremont CA 94538, USA

Tel: +1-510-656-2248

Fax: +1-510-656-2158

Email: [sales@nexcom.com](mailto:sales@nexcom.com)

[www.nexcom.com](http://www.nexcom.com)

### Asia

#### **Taiwan**

#### **NEXCOM Intelligent Systems**

#### **Taipei Office**

13F, No.920, Chung-Cheng Rd.,  
ZhongHe District,  
New Taipei City, 23586, Taiwan, R.O.C.

Tel: +886-2-8226-7796

Fax: +886-2-8226-7792

Email: [sales@nexcom.com.tw](mailto:sales@nexcom.com.tw)

[www.nexcom.com.tw](http://www.nexcom.com.tw)

### **NEXCOM Intelligent Systems**

#### **Taichung Office**

16F, No.250, Sec. 2, Chongde Rd.,  
Beitun Dist.,

Taichung City 406, R.O.C.

Tel: +886-4-2249-1179

Fax: +886-4-2249-1172

Email: [sales@nexcom.com.tw](mailto:sales@nexcom.com.tw)

[www.nexcom.com.tw](http://www.nexcom.com.tw)

### **Japan**

#### **NEXCOM Japan**

9F, Tamachi Hara Bldg.,  
4-11-5, Shiba Minato-ku,  
Tokyo, 108-0014, Japan

Tel: +81-3-5419-7830

Fax: +81-3-5419-7832

Email: [sales@nexcom-jp.com](mailto:sales@nexcom-jp.com)

[www.nexcom-jp.com](http://www.nexcom-jp.com)

### **China**

#### **NEXCOM China**

1F & 2F, Block A, No. 16 Yonyou Software Park,  
No. 68 Beiqing Road, Haidian District,  
Beijing, 100094, China

Tel: +86-10-5704-2680

Fax: +86-10-5704-2681

Email: [sales@nexcom.cn](mailto:sales@nexcom.cn)

[www.nexcom.cn](http://www.nexcom.cn)

## **NEXCOM Shanghai**

Room 603/604, Huiyinmingzun Plaza Bldg., 1,  
No.609, Yunlin East Rd.,  
Shanghai, 200333, China  
Tel: +86-21-5278-5868  
Fax: +86-21-3251-6358  
Email: sales@nexcom.cn  
www.nexcom.cn

## **NEXCOM Surveillance Technology**

Room 209, Floor 2 East, No.2,  
Science & Technology industrial park of  
privately owned enterprises,  
Xili, Nanshan Dist.,  
Shenzhen, 518055, China  
Tel: +86-755-8364-7768  
Fax: +86-755-8364-7738  
Email: steveyang@nexcom.com.tw  
www.nexcom.cn

## **NEXCOM United System Service**

Hui Yin Ming Zun Building Room 1108,  
Building No. 11, 599 Yunling Road, Putuo District,  
Shanghai, 200062, China  
Tel: +86-21-6125-8282  
Fax: +86-21-6125-8281  
Email: frankyang@nexcom.cn  
www.nexcom.cn

## **Europe**

### **United Kingdom**

#### **NEXCOM EUROPE**

10 Vincent Avenue,  
Crownhill Business Centre,  
Milton Keynes, Buckinghamshire  
MK8 0AB, United Kingdom  
Tel: +44-1908-267121  
Fax: +44-1908-262042  
Email: sales.uk@nexcom.eu  
www.nexcom.eu

### **Italy**

#### **NEXCOM ITALIA S.r.l**

Via Lanino 42,  
21047 Saronno (VA), Italia  
Tel: +39 02 9628 0333  
Fax: +39 02 9625 570  
Email: nexcomitalia@nexcom.eu  
www.nexcomitalia.it

## Package Contents

Before continuing, verify that the NDiS B425-SI3 package that you received is complete. Your package should have all the items listed in the following table.

Item	Name	Qty
1	Power adapter	1
2	Driver DVD	1



**Power Adapter**

## Ordering Information

The following below provides ordering information for NDiS B425-SI3.

- **Barebone**

**NDiS B425-SI3 (P/N: 10W00B42503X0)**

6th generation Intel® Core i3-6100U Dual Core fanless system

- **Optional**

**VESA Mount Kit (P/N: 10W00B42504X0)**

NDiS B425-SI3 VESA mount kit

**Wall Mount Kit (P/N: 10W00B42505X0)**

NDiS B425-SI3 wall mount kit

# CHAPTER 1: PRODUCT INTRODUCTION

## NDiS B425-SI3

### Overview



NDiS B425-SI3 comes with a compact fanless design and is powered by 6th generation Intel® Core i3-6100U SoC processor, integrated with Intel® HD520 Graphics controller can handle very rich multimedia contents. NDiS B425-SI3 supports display output by HDMI and Mini-DP ports, it can offer impressive system performance and 4Kx2K videos. The NDiS B425-SI3 signage player can fully satisfy customer's expectation and therefore be used in applications such as advertising, hospitality, brand promotion, digital menu board, and many more.

### Key Features

- 6th generation Intel® Core™ i3-6100U SoC processor
- HDMI (4K Resolution) dual output
- USB 3.0 support
- WLAN support
- Compact and fanless design
- Wide temperature support

## Hardware Specifications

### CPU Support

- Intel® Core i3-6100U SoC processor Dual Core 2.3GHz

### Graphics

- Intel® HD520 Graphics

### Main Memory

- 2x 260-pin SO-DIMM Sockets, support DDR4 1866/2133 MHz non-ECC, un-buffered memory up to 16G

### I/O Interface-Front

- 1x Power Switch with LED
- 2x USB 3.0
- 1x Headset/Mic phone jack
- 2x Antenna Hole

### I/O Interface-Rear

- +19V DC-in
- 1x HDMI
- 1x Mini-DisplayPort
- 1x DB9 for RS-232
- 2x USB 3.0
- 1x RJ45 with LED for 10/100/1000Mbps Ethernet

### Storage

- 1x 2.5" HDD/SSD

### Dimensions

- 167mm (W) x 139.6mm (D) x 55mm (H), w/o mounting bracket

### Construction

- Top cover made by aluminum for main heat exchange

### Power Supply

- 1x External 65W AC/DC adapter
- Input: 100~240VAC
- Output: +19V

### Expansion

- 1 x NGFF (M.2) E key for optional 2230 WLAN module
- 1 x NGFF (M.2) for optional 2280 Storage module

### Environment

- Operating temperature: 0°C to 40°C
- Storage temperature: -20°C to 80°C
- Humidity: 10 to 90% (non-condensing)

### Certifications

- CE approval
- FCC Class A

### Operating System

- Win7/Win8/Win10/WES7/WES8/Linux



# Knowing Your NDiS B425-SI3

## Front Panel

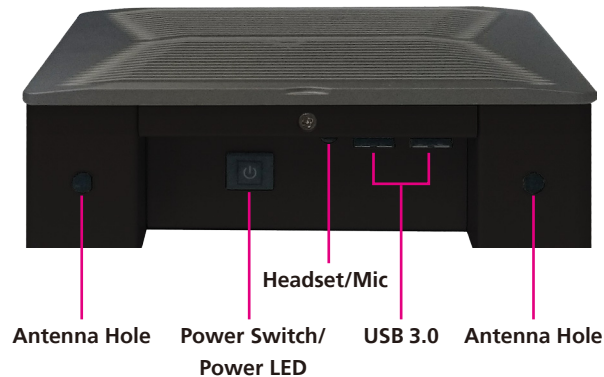

### Antenna Holes for Optional Wi-Fi

The 2 external antenna mounting holes are used to mount and connect optional Wi-Fi/GPS/GSM antennas.

### Power Switch/Power LED

Power switch with power status LED indicator. Press to power-on or power-off the system.

### USB 3.0 Ports

Used to connect USB 3.0/2.0/1.1 devices.

### Headset/Mic Combo Jack

Used to connect a headphone or microphone.

## Rear Panel

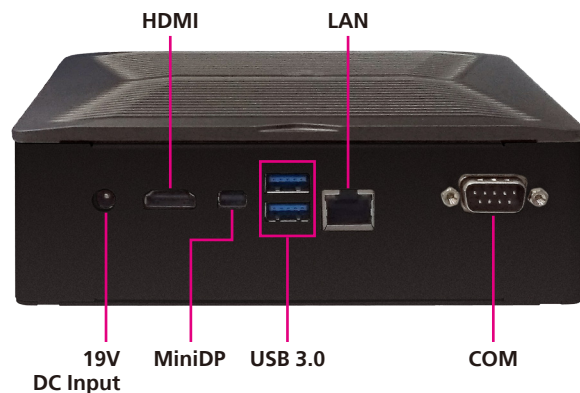

### 19V DC Input

Used to plug a DC power cord.

### HDMI Port

Used to connect an HDMI interface monitor.

### Mini DisplayPort

Used to connect a Mini DisplayPort interface monitor.

### USB 3.0 Ports

Used to connect USB 3.0/2.0/1.1 devices.

### LAN Port

Used to connect the system to a local area network.

### COM Port

The COM port supports RS232 compatible serial devices.

# Mechanical Dimensions

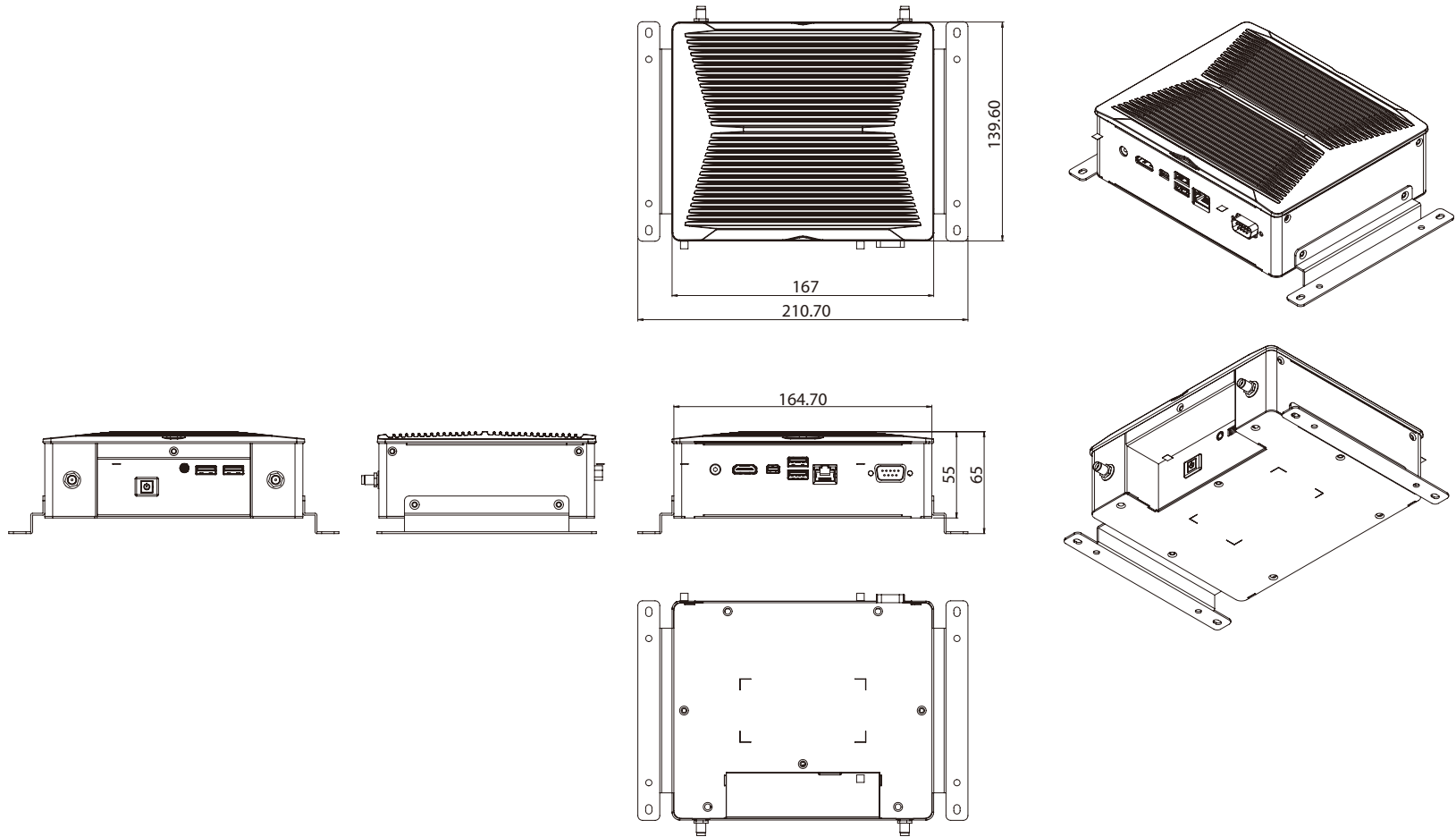

## CHAPTER 2: JUMPERS AND CONNECTORS

This chapter describes how to set the jumpers and connectors for NDiS B425-SI3.

### Before You Begin

- Ensure you have a stable, clean working environment. Dust and dirt can get into components and cause a malfunction. Use containers to keep small components separated.
- Adequate lighting and proper tools can prevent you from accidentally damaging the internal components. Most of the procedures that follow require only a few simple tools, including the following:
  - A Philips screwdriver
  - A flat-tipped screwdriver
  - A set of jewelers screwdrivers
  - A grounding strap
  - An anti-static pad
- Using your fingers can disconnect most of the connections. It is recommended that you do not use needle-nosed pliers to disconnect connections as these can damage the soft metal or plastic parts of the connectors.
- Before working on internal components, make sure that the power is off. Ground yourself before touching any internal components, by touching a metal object. Static electricity can damage many of the electronic components. Humid environments tend to have less static electricity than dry environments. A grounding strap is warranted whenever danger of static electricity exists.

### Precautions

Computer components and electronic circuit boards can be damaged by discharges of static electricity. Working on computers that are still connected to a power supply can be extremely dangerous.

Follow the guidelines below to avoid damage to your computer or yourself:

- Always disconnect the unit from the power outlet whenever you are working inside the case.
- If possible, wear a grounded wrist strap when you are working inside the computer case. Alternatively, discharge any static electricity by touching the bare metal chassis of the unit case, or the bare metal body of any other grounded appliance.
- Hold electronic circuit boards by the edges only. Do not touch the components on the board unless it is necessary to do so. Don't flex or stress the circuit board.
- Leave all components inside the static-proof packaging that they shipped with until they are ready for installation.
- Use correct screws and do not over tighten screws.

## Jumper Settings

A jumper is the simplest kind of electric switch. It consists of two metal pins and a cap. When setting the jumpers, ensure that the jumper caps are placed on the correct pins. When the jumper cap is placed on both pins, the jumper is short. If you remove the jumper cap, or place the jumper cap on just one pin, the jumper is open.

Refer to the illustrations below for examples of what the 2-pin and 3-pin jumpers look like when they are short (on) and open (off).

Two-Pin Jumpers: Open (Left) and Short (Right)

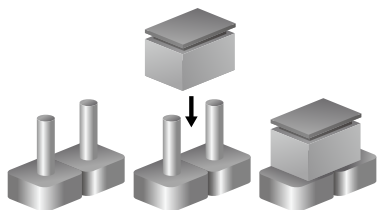

Three-Pin Jumpers: Pins 1 and 2 are Short

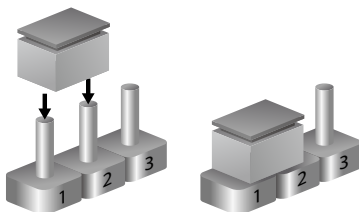

# Location of the Jumpers and Connectors

## Top View

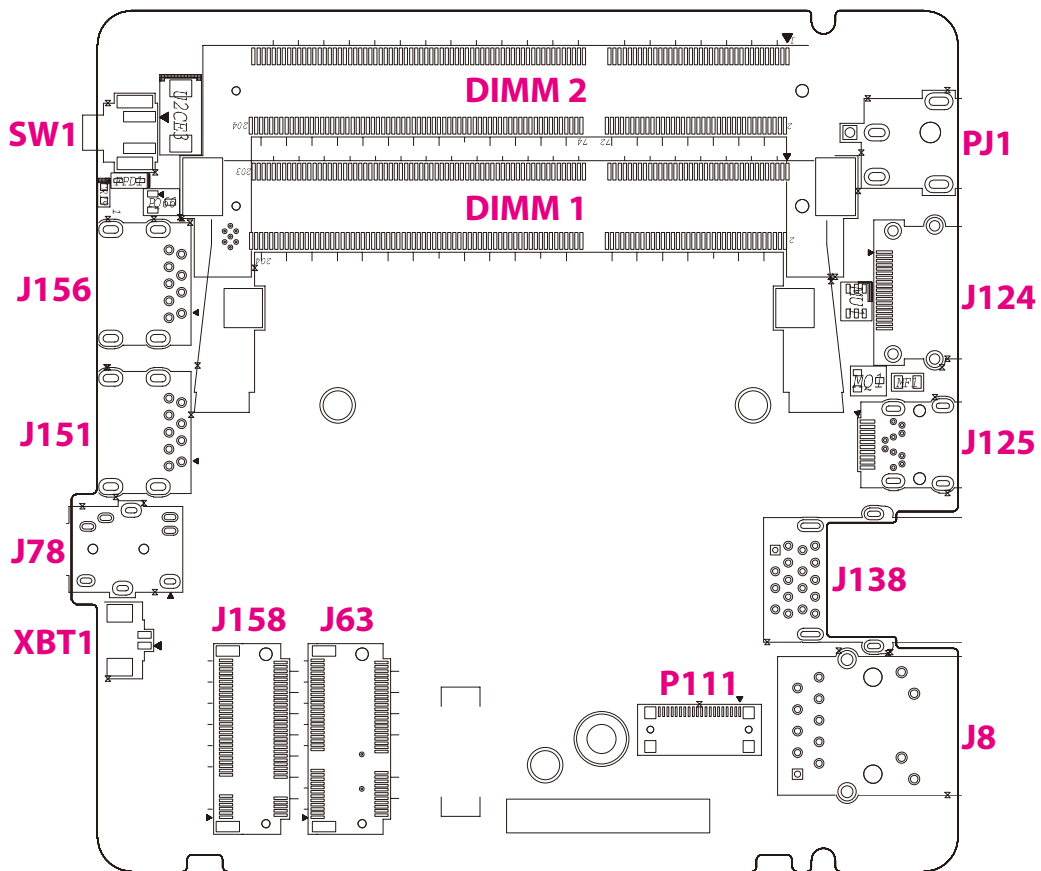

## Bottom View

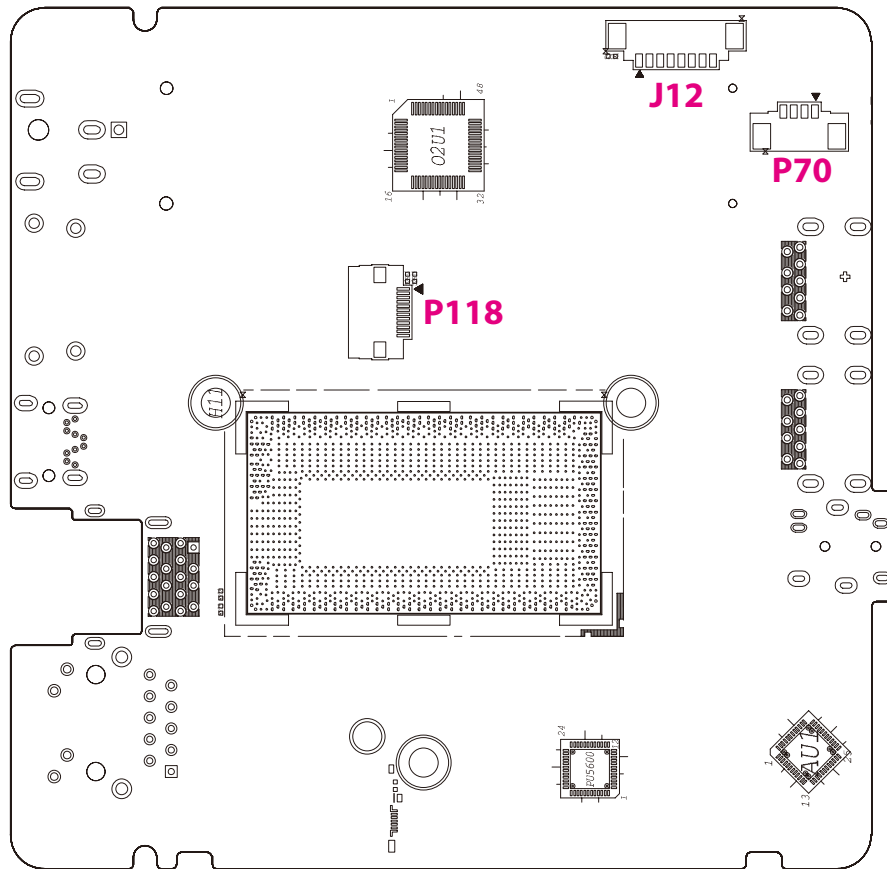

## Connector/Button Table

Connector	Name
SW1	Power Button
DIMM1	DDR4 SO-DIMM Slot
DIMM2	DDR4 SO-DIMM Slot
P110	SATA HDD Connector
J63	NGFF M.2 E Key Connector (For 2230)
J158	NGFF M.2 M Key Connector (For 2242)
J156	USB 3.0 Connector
J151	USB 3.0 Connector
J78	Headset/Microphone Phone Jack
J8	RJ45 GbE LAN Connector
J138	Dual USB 3.0 Connector
J125	Mini DisplayPort Connector
J124	HDMI Connector
PJ1	DC 19V Power-in Connector

## Header/Wafer Table

Connector	Name
P70	Power LED
J12	USB Pin Header
P118	Debug Wafer
XBT1	RTC Battery Wafer



## CHAPTER 3: SYSTEM SETUP

### Installing a SATA HDD



Prior to removing the chassis cover, make sure the unit's power is off and disconnected from the power sources to prevent electric shock or system damage.

1. Remove the mounting screws around the chassis cover and then remove the cover.

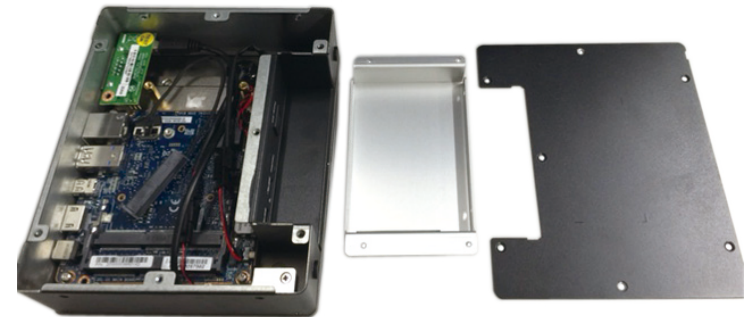

2. Align the mounting holes that are on the sides of the SATA drive with the mounting holes on the drive bay and then use the provided mounting screws to secure the drive in place.



3. Place the SATA drive in the chassis and connect the SATA data connector, then use screws to secure the drive in the chassis.

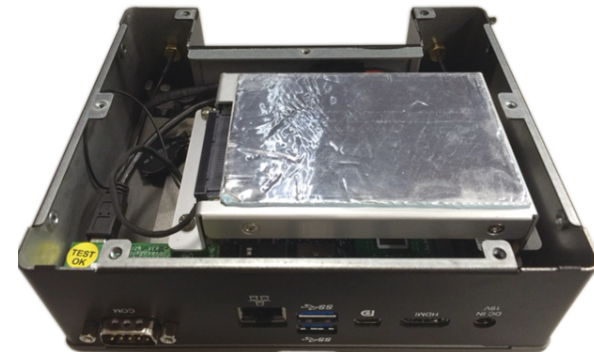

## Installing a SO-DIMM Memory Module

1. Insert the module into the socket at an approximately 30 degrees angle. Apply firm even pressure to each end of the module until it slips into the socket. The gold-plated connector on the edge of the module will almost completely disappear inside the socket.
2. Push the module down until the clips on both sides of the socket lock into position. You will hear a distinctive “click” sound, indicating the module is correctly locked into position.

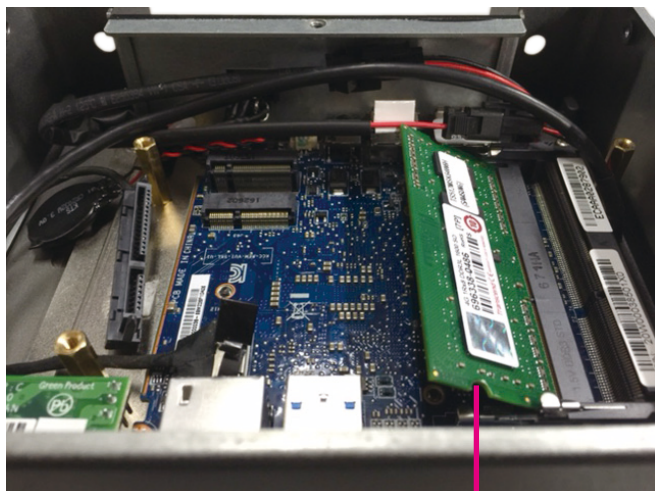

Memory module

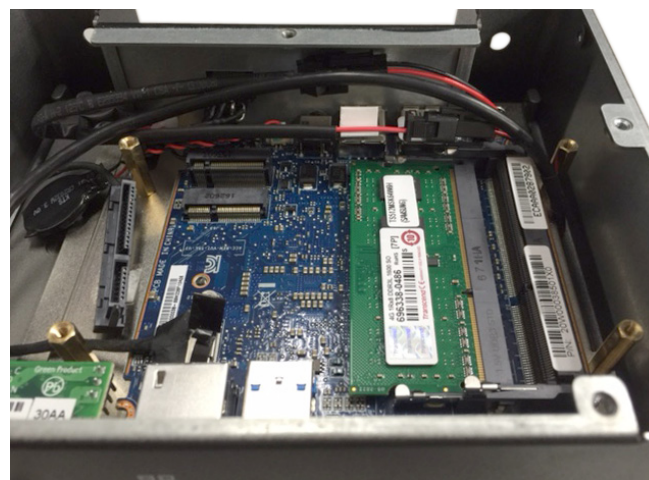

## Installing a NGFF M.2 Wi-Fi Module (Optional)

1. The NGFF M.2 Wi-Fi module package includes the following items.



NGFF M.2 Wi-Fi Module



Antennas

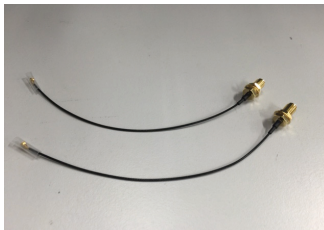

RF Cables

2. Insert the NGFF M.2 Wi-Fi Module into the NGFF M.2 slot at a 45 degrees angle until the gold-plated connector on the edge of the module completely disappears inside the slot.



3. Secure the module with mounting screws.

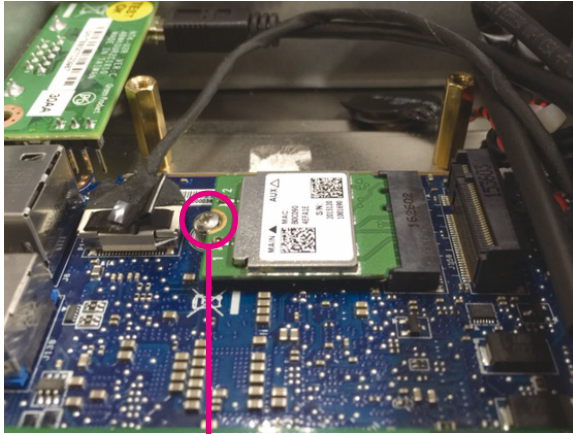

**Mounting screw**

4. Attach one end of the RF cables onto the module.

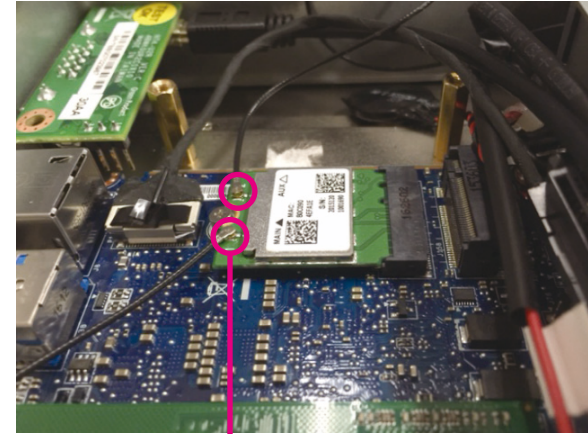

**RF cable**

5. Insert the antenna jack end of the cable through the antenna hole.

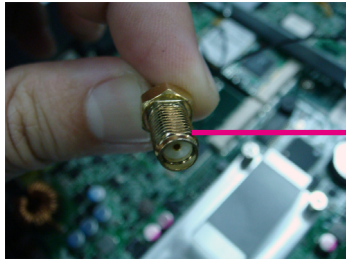

Antenna jack  
end of the cable

6. Insert ring 1 and ring 2 onto the antenna jack end of the cable.

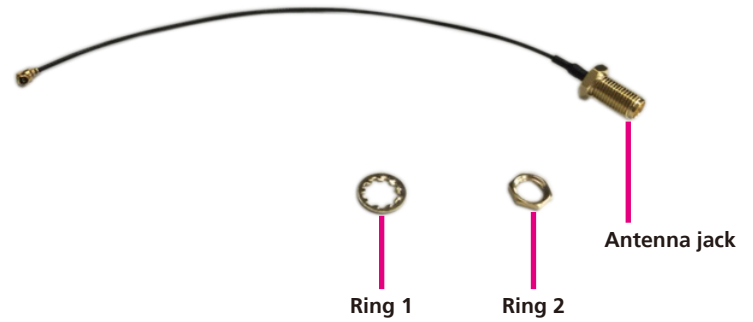

## Installing Wall Mount Brackets

1. Align the mounting holes on the wall mount brackets to the mounting holes on both sides of the system, then secure the brackets with screws.



## Installing the VESA Mount Kit

1. Align the mounting holes on the VESA mount kit to the VESA mounting holes on the back of the monitor, then secure the VESA mount kit with screws.

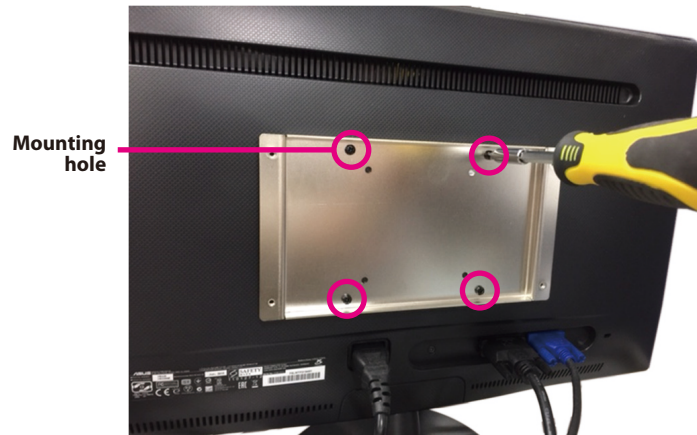

2. Secure the system to the VESA mount bracket with screws.





# CHAPTER 4: BIOS SETUP

This chapter describes how to use the BIOS setup program for the NDiS B425-SI3. The BIOS screens provided in this chapter are for reference only and may change if the BIOS is updated in the future.

To check for the latest updates and revisions, visit the NEXCOM website at [www.nexcom.com.tw](http://www.nexcom.com.tw).

## About BIOS Setup

The BIOS (Basic Input and Output System) Setup program is a menu driven utility that enables you to make changes to the system configuration and tailor your system to suit your individual work needs. It is a ROM-based configuration utility that displays the system's configuration status and provides you with a tool to set system parameters.

These parameters are stored in non-volatile battery-backed-up CMOS RAM that saves this information even when the power is turned off. When the system is turned back on, the system is configured with the values found in CMOS.

With easy-to-use pull down menus, you can configure such items as:

- Hard drives, diskette drives, and peripherals
- Video display type and display options
- Password protection from unauthorized use
- Power management features

The settings made in the setup program affect how the computer performs. It is important, therefore, first to try to understand all the setup options, and second, to make settings appropriate for the way you use the computer.

## When to Configure the BIOS

- This program should be executed under the following conditions:
  - When changing the system configuration
  - When a configuration error is detected by the system and you are prompted to make changes to the setup program
  - When resetting the system clock
  - When redefining the communication ports to prevent any conflicts
  - When making changes to the Power Management configuration
  - When changing the password or making other changes to the security setup

Normally, CMOS setup is needed when the system hardware is not consistent with the information contained in the CMOS RAM, whenever the CMOS RAM has lost power, or the system features need to be changed.

## Default Configuration

Most of the configuration settings are either predefined according to the Load Optimal Defaults settings which are stored in the BIOS or are automatically detected and configured without requiring any actions. There are a few settings that you may need to change depending on your system configuration.

## Entering Setup











When the system is powered on, the BIOS will enter the Power-On Self Test (POST) routines. These routines perform various diagnostic checks; if an error is encountered, the error will be reported in one of two different ways:

- If the error occurs before the display device is initialized, a series of beeps will be transmitted.
- If the error occurs after the display device is initialized, the screen will display the error message.

Powering on the computer and immediately pressing <Del> allows you to enter Setup.

Press the  key to enter Setup:

## Legends

Key	Function
	Moves the highlight left or right to select a menu.
	Moves the highlight up or down between sub-menus or fields.
	Exits the BIOS Setup Utility.
	Scrolls forward through the values or options of the highlighted field.
	Scrolls backward through the values or options of the highlighted field.
	Selects a field.
	Displays General Help.
	Discards changes.
	Load optimized default values.
	Saves and exits the Setup program.
	Press <Enter> to enter the highlighted sub-menu

## Scroll Bar

When a scroll bar appears to the right of the setup screen, it indicates that there are more available fields not shown on the screen. Use the up and down arrow keys to scroll through all the available fields.

## Submenu

When “▶” appears on the left of a particular field, it indicates that a submenu which contains additional options are available for that field. To display the submenu, move the highlight to that field and press  .

## BIOS Setup Utility

Once you enter the AMI BIOS Setup Utility, the Main Menu will appear on the screen. The main menu allows you to select from several setup functions and one exit. Use arrow keys to select among the items and press  to accept or enter the submenu.

### Main

The Main menu is the first screen that you will see when you enter the BIOS Setup Utility.



### System Date

The date format is <day>, <month>, <date>, <year>. Day displays a day, from Monday to Sunday. Month displays the month, from January to December. Date displays the date, from 1 to 31. Year displays the year, from 1999 to 2099.

### System Time

The time format is <hour>, <minute>, <second>. The time is based on the 24-hour military-time clock. For example, 1 p.m. is 13:00:00. Hour displays hours from 00 to 23. Minute displays minutes from 00 to 59. Second displays seconds from 00 to 59.

### Halt On

Select the situation in which you want the BIOS to stop the POST process and notify you.

## Advanced

The Advanced menu allows you to configure your system for basic operation. Some entries are defaults required by the system board, while others, if enabled, will improve the performance of your system or let you set some features according to your preference.



Setting incorrect field values may cause the system to malfunction.

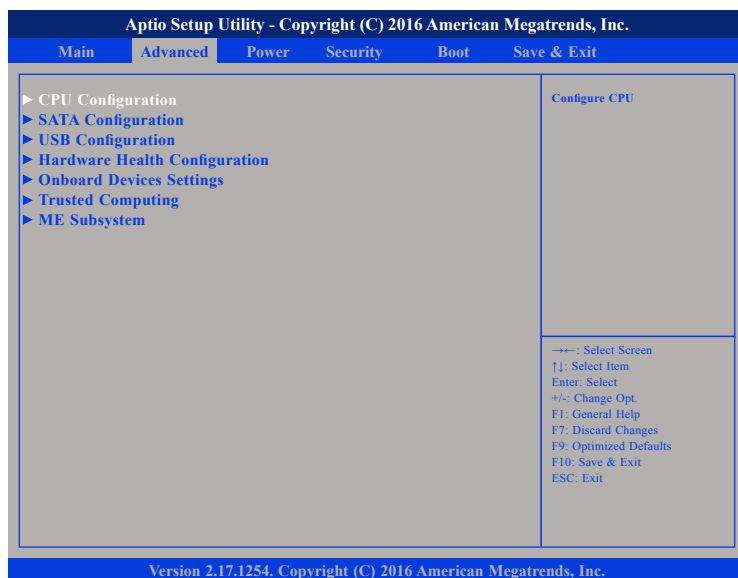

## CPU Configuration

This section is used to view CPU status and configure parameters.

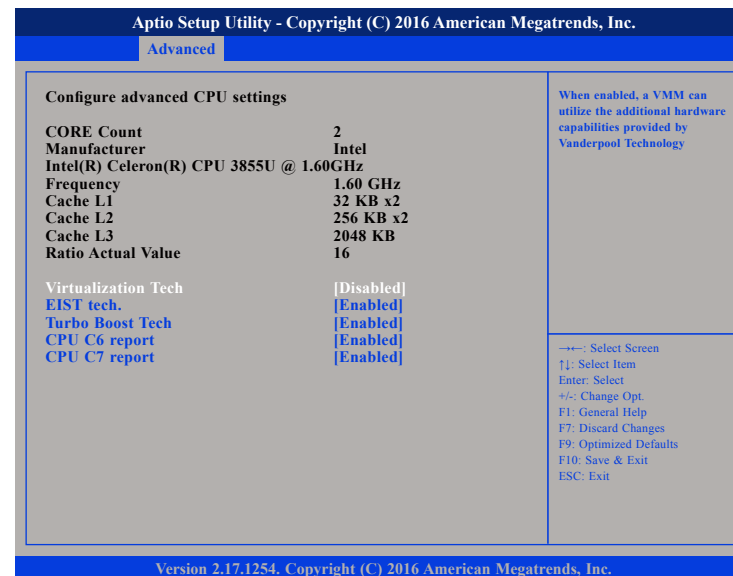

### Virtualization Tech

When this field is set to Enabled, the VMM can utilize the additional hardware capabilities provided by Vanderpool Technology.

### EIST tech.

Enables or disables Intel® SpeedStep.

### Turbo Boost Tech

Use this item to enable or disable Intel Turbo Boost Mode Technology. Turbo Boost Mode allows processor cores to run faster than marked frequency in specific conditions.

### CPU C6 Report and CPU C7 Report

Enables or disables C6 report and C7 report to the operating system.

## SATA Configuration

This section is used to configure storage devices.



### SATA Controller

Enables or disables the SATA controller.

### SATA Mode Selection

Configures the SATA as AHCI mode.

**AHCI** This option configures the Serial ATA drives to use AHCI (Advanced Host Controller Interface). AHCI allows the storage driver to enable the advanced Serial ATA features which will increase storage performance.

## USB Configuration

This section is used to configure USB parameters.

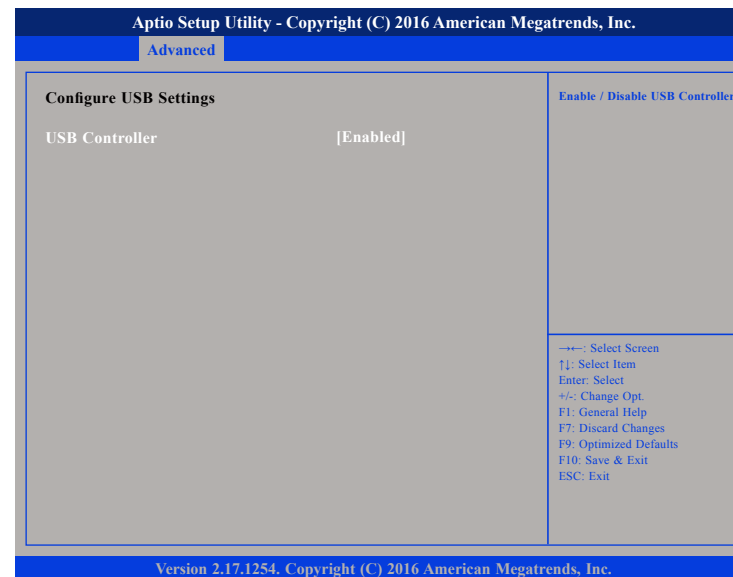

### USB Controller

Enables or disables the USB controller.

## Hardware Health Configuration

This section is used to monitor hardware status such as temperature, fan speed and voltages.

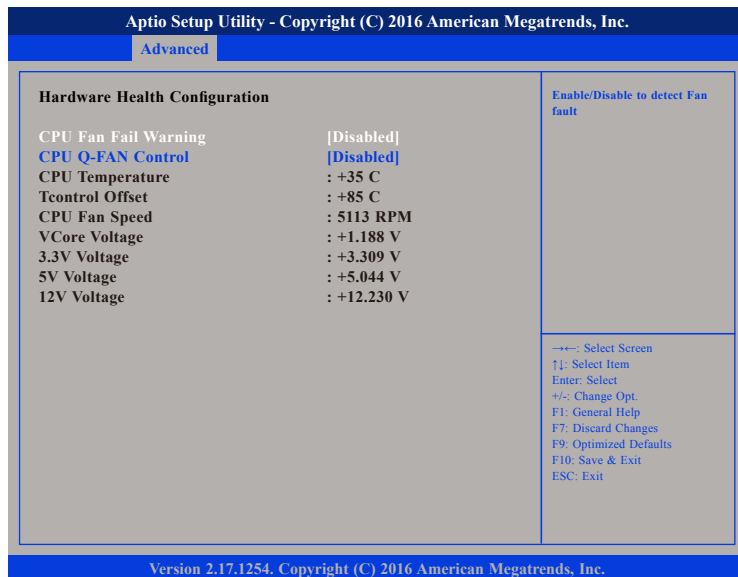

### CPU Fan Fail Warning

Enables or disables detection of fan failure.

### CPU Q-FAN Control

Enables or disables control of CPU fan speed.

### CPU Temperature

Detects and displays the current CPU temperature.

### Tcontrol Offset

Displays the Tcontrol offset temperature.

### CPU Fan Speed

Detects and displays the current CPU fan speed.

### VCore Voltage

Detects and displays the Vcore CPU voltage.

### 3.3V Voltage

Detects and displays 3.3V voltage.

### 5V Voltage

Detects and displays 5V voltage.

### 12V Voltage

Detects and displays 12V voltage.

## Onboard Device Settings

This section is used to configure the onboard devices.

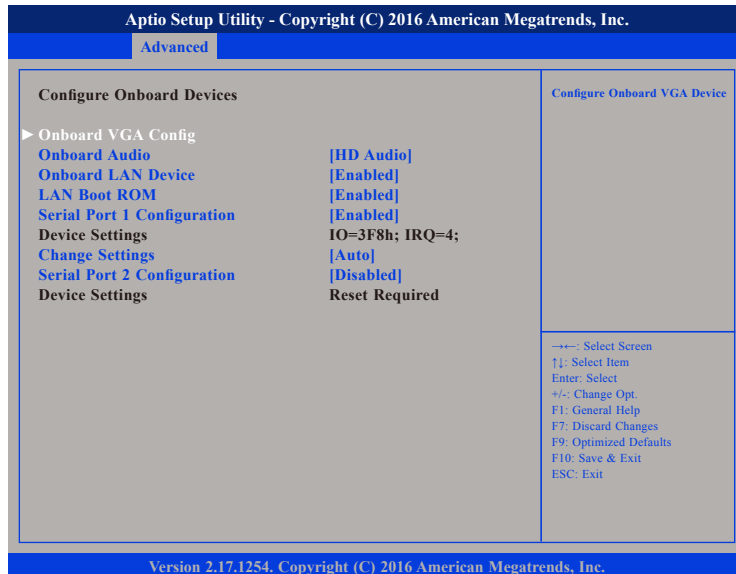

### Onboard VGA Config

Configuration for onboard VGA devices.

### Onboard Audio

Enables or disables onboard HD audio.

### Onboard LAN Device

Enables or disables onboard LAN.

### LAN Boot ROM

Enables or disables LAN legacy PXE boot.

### Serial Port 1 Configuration

Enables or disables serial port 1.

### Serial Port 2 Configuration

Enables or disables serial port 2.



## Onboard VGA Config

This section is used to configure onboard VGA devices.



### Pre-Allocated Memory Size

Selects the amount of system memory used by the internal graphics device.

### DVMT Fixed Memory Size

Selects the graphics memory size used by the DVMT.

## Trusted Computing

This section is used to configure Trusted Platform Module (TPM) settings.

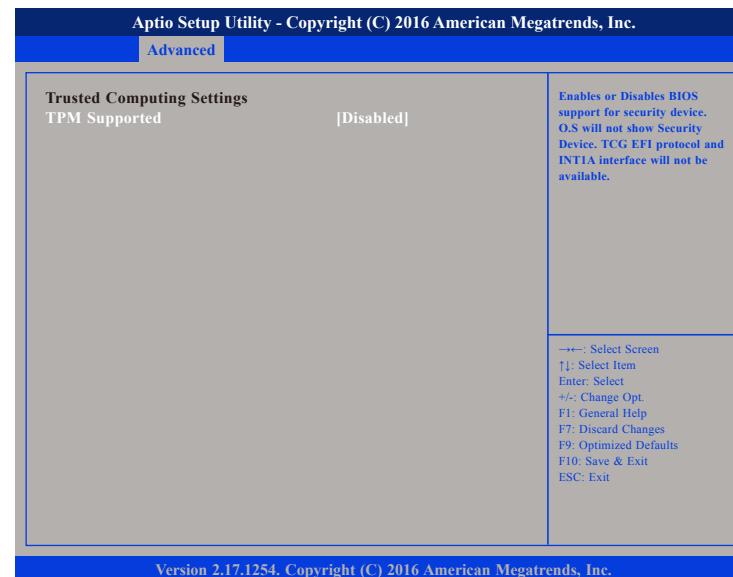

### TPM Supported

Enables or disables BIOS support for security device. O.S will not show security device. TCG EFI protocol and INT1A interface will not be available.

## ME Subsystem

This section is used to configure Intel® Management Engine (Intel® ME).

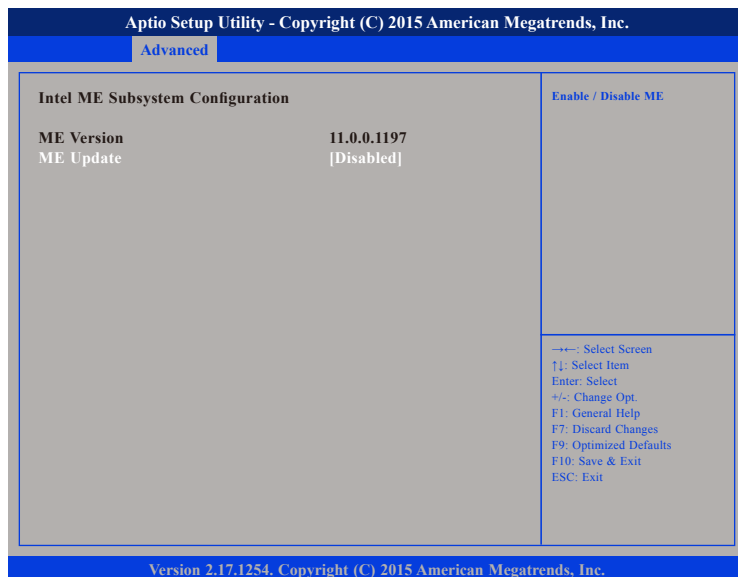

### ME Update

Enables or disables Intel ME.

## Power

This section is used to configure the power management features.

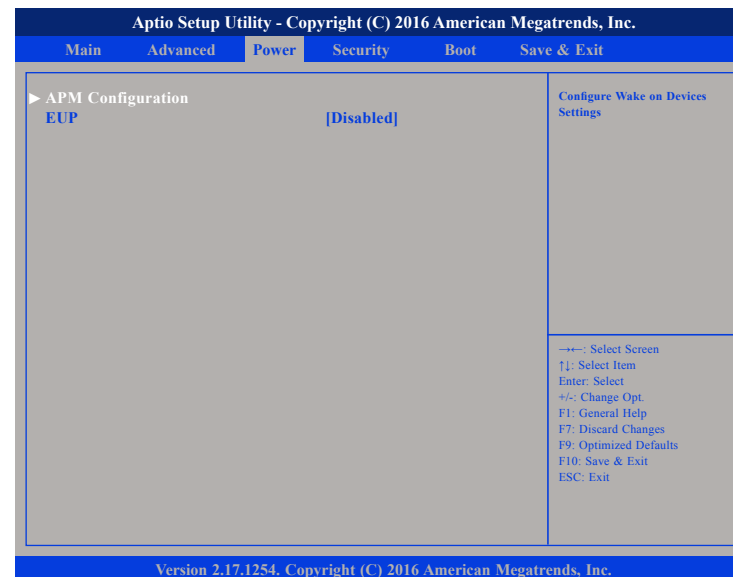

### APM Configuration

Configuration for Advanced Power Management.

### EUP

Enables the system to shut down to the lowest possible power state by removing all power to the system board. The wake up function will be lost if EUP is enabled.

## APM Configuration

Aptio Setup Utility - Copyright (C) 2016 American Megatrends, Inc.	
Power	
<b>APM Configuration</b>	<b>Configure Resume BY LAN</b>
Wake Up On Lan	[Enabled]
Power On RTC Alarm	[Enabled]
RTC Alarm Date	0
RTC Alarm Hour	0
RTC Alarm Minute	0
RTC Alarm Second	0
AC Power Loss	[Power On]
<b>Watch Dog</b>	[Disabled]
	→←: Select Screen ↑↓: Select Item Enter: Select +/-: Change Opt. F1: General Help F7: Discard Changes F9: Optimized Defaults F10: Save & Exit ESC: Exit
Version 2.17.1254. Copyright (C) 2016 American Megatrends, Inc.	

### Wake up on LAN

Enables or disable the system to wake up on LAN.

### Power on RTC Alarm

Enables or disables the system to wake up on RTC alarm. When enabled, the system will wake on the hr::min::sec specified.

### RTC Alarm Date, Hour, Minute and Second

Configures the date and time of the RTC alarm.

### AC Power Loss

**Power Off** When power returns after an AC power failure, the system's power is off. You must press the power button to power-on the system.

**Power On** When power returns after an AC power failure, the system will automatically power-on.

**Last State** When power returns after an AC power failure, the system will return to the state where you left off before power failure occurs. If the system's power is off when AC power failure occurs, it will remain off when power returns. If the system's power is on when AC power failure occurs, the system will power-on when power returns.

### Watchdog

Enables or disables the watchdog function.

## Security



### Administrator Password

Select this to reconfigure the administrator's password.

### Secure Boot

Select this to enable or disable Secure Boot. Secure Boot only works when the system runs in user mode.

### Secure Boot Mode

Select this to configure the Secure Boot mode.

Standard	Fixed secure boot policy.
Custom	Changeable Image Execution policy and Secure Boot key databases.

## Boot

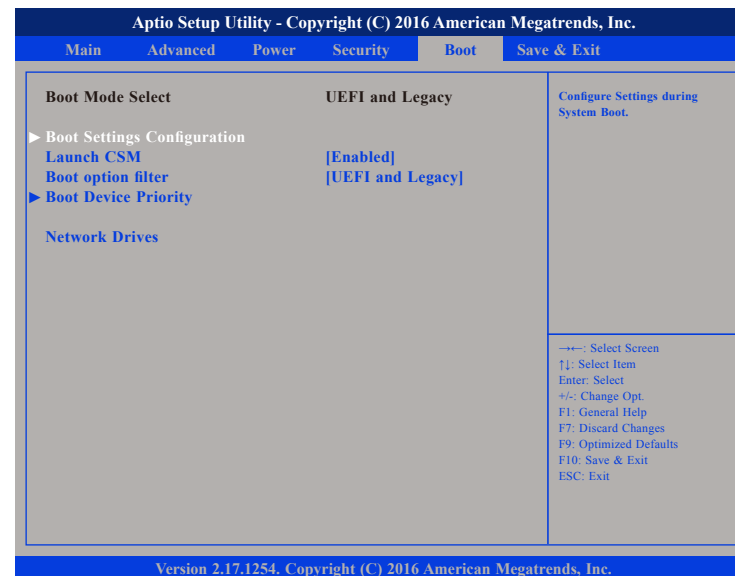

### Launch CSM

This option controls if CSM will be launched.

### Boot Option Filter

Configures which devices the system will boot from.

### Network Drives

Sets the order of the legacy devices in this group.

## Boot Settings Configuration



### Keyboard Error Message Display

This item allows you to enable or disable the “Keyboard Error” message during bootstrap.

### Fast Boot

When enabled, the BIOS will shorten or skip some check items during POST. This will decrease the time needed to boot the system.

### Full Screen Logo

Enables or disables full screen logo.

### Bootup Num-Lock

This allows you to determine the default state of the numeric keypad. By default, the system boots up with NumLock on wherein the function of the numeric keypad is the number keys. When set to Off, the function of the numeric keypad is the arrow keys.

## Boot Device Priority

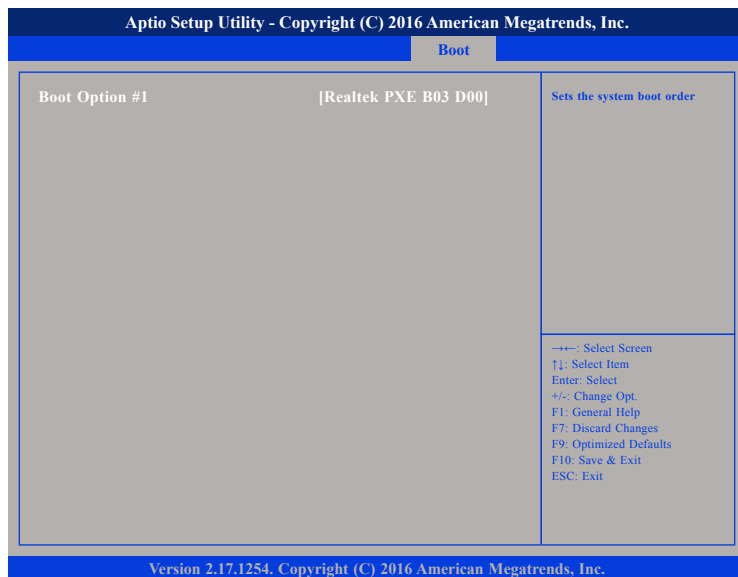

Adjust the boot sequence of the system. Boot Option #1 is the first boot device that the system will boot from, next will be #2 and so forth.

## Save & Exit



### Save Changes and Exit

To save the changes and exit the Setup utility, select this field then press <Enter>. A dialog box will appear. Confirm by selecting Yes. You can also press <F4> to save and exit Setup.

### Discard Changes and Exit

To exit the Setup utility without saving the changes, select this field then press <Enter>. You may be prompted to confirm again before exiting. You can also press <ESC> to exit without saving the changes.

### Load Optimal Defaults

To restore the BIOS to default settings, select this field then press <Enter>. A dialog box will appear. Confirm by selecting Yes.

# APPENDIX A: WATCHDOG

## Watchdog Timer Control Register (Index=71h, Default=00h)

Bit	Description
7	WDT is reset upon a CIR interrupt.
6	WDT is reset upon a KBC (Mouse) interrupt.
5	WDT is reset upon a KBC (Keyboard) interrupt.
4	<b>WDT Output through RSTCONOUT (pulse) Enable</b> 1: Enable 0: Disable
3	<b>External CLK_IN Select</b> 0: CLKIN 1: PCICLK
2	<b>Reserved</b>
1	<b>Force Time-out</b> This bit is self-cleared.
0	<b>WDT Status</b> 1: WDT value is equal to 0. 0: WDT value is not equal to 0.

## SMI# Control Register 2 (Index=F1h, Default=00h)

Bit	Description
7	<b>Reserved</b>
6	0: Edge trigger 1: Level trigger
5-3	<b>Reserved</b>
2	This bit is to enable the generation of a SMI# due to WDT's IRQ (EN_WDT).
1	This bit is to enable the generation of a SMI# due to CIR's IRQ (EN_CIR).
0	This bit is to enable the generation of a SMI# due to PBD's IRQ (EN_PBD).

## SMI# Status Register 2 (Index=F3h, Default=00h)

This register is used to read the status of SMI# inputs.

Bit	Description
7-6	<b>Panel Button De-bounce Status 1-0</b> Writing 1 will reset the status. 0: None detected 1: Detected
5-4	<b>Reserved</b>
3	<b>Reserved</b>
2	<b>WDT's IRQ</b>
1	<b>CIR's IRQ</b>
0	<b>PBD's IRQ</b>

### Watchdog Timer Configuration Register (Index=72h, Default=001s0000b)

Bit	Description
7	<b>WDT Time-out Value Select 1</b> 1: Second 0: Minute
6	<b>WDT Output through KRST (pulse) Enable</b> 1: Enable 0: Disable
5	<b>WDT Time-out Value Extra Select</b> 1: 62.5ms x WDT Timer-out value (default = 3.5s) 0: Determined by WDT Time-out value select 1 (bit 7 of this register)
4	<b>WDT Output through PWRGD Enable</b> 1: Enable 0: Disable <i>During LRESET# this bit is selected by JP2 power-on strapping option.</i>
3-0	<b>Interrupt Level Select for WDT</b> Please refer to Interrupt Level Mapping Table.

### Watchdog Timer Time-out Value (LSB) Register (Index=73h, Default=38h)

Bit	Description
7-0	WDT Time-out Value 7-0

### Watchdog Timer Time-out Value (MSB) Register (Index=74h, Default=00h)

Bit	Description
7-0	WDT Time-out Value 15-8