



**NEXCOM International Co., Ltd.**

**Intelligent Digital Security**

**IP Camera**

**NCb-311**

User Manual

# CONTENTS

## Preface

Copyright .....	iv
Disclaimer .....	iv
Acknowledgements .....	iv
Regulatory Compliance Statements .....	iv
Declaration of Conformity .....	iv
RoHS Compliance .....	v
Safety Information .....	vi
Installation Recommendations .....	vi
Safety Precautions .....	vii
Technical Support and Assistance .....	viii
Conventions Used in this Manual .....	viii
Package Contents .....	ix

## Chapter 1: Product Introduction

Overview .....	1
Key Features .....	1
Hardware Specifications .....	2
Physical Descriptions .....	3
D/I/O Pinout Assignment .....	3
Hardware Installation .....	4

## Chapter 2: Camera Configuration

Accessing the Camera's Configuration Menu (Graphical User Interface) ..	5
Installing NexCam Assistant .....	5

NexCam Assistant .....	8
Web Browser (Internet Explorer) .....	10
Configuring the Camera's Setting .....	11
Browsing Through the Configuration Menu .....	12
Video .....	13
Video Stream .....	13
Stream 1 (H.264) .....	13
Stream 2 (H.264) .....	14
Stream 3 (MJPEG) .....	14
Camera Settings .....	15
Image Adjustments .....	15
Mirror & Flip .....	16
White Balance .....	16
Exposure .....	16
Day & Night .....	17
Overlay Settings .....	18
Contents .....	18
Privacy Mask .....	19
Settings .....	19
Mask Zones .....	20
Network .....	21
TCP/IP .....	21
IP Address Configuration .....	21
Current Network Settings .....	21
FTP .....	22
FTP Server .....	22

- Login Information ..... 22
- Test Remote FTP Server..... 22
- SMTP..... 23
  - SMTP Server..... 23
  - Login Information ..... 23
- Ports..... 24
  - HTTP ..... 24
  - RTSP ..... 24
- Events..... 25
  - Motion Detection ..... 25
    - Settings..... 25
    - Detection Zones..... 26
  - Alarm In/Out Trigger..... 27
    - Alarm In Out Actions..... 27
  - Event Actions ..... 28
    - When Motion Detection Triggered ..... 28
    - When Alarm In Triggered ..... 28
- System..... 30
  - Audio ..... 30
    - Audio Settings ..... 30
  - User Management..... 31
    - Add/Modify User Accounts..... 31
    - User List..... 31
  - SD Card Management..... 32
    - SD Card Information ..... 32
    - File List..... 32
  - Date & Time ..... 33
    - Current Camera Time..... 33
    - Time Settings ..... 33
    - Date & Time Format..... 34
    - NTP Server ..... 34
  - Firmware Upgrade..... 35

- Firmware Version ..... 35
- Update..... 35
- Maintenance ..... 36
  - Maintain ..... 36
  - Camera Name Settings..... 36

**Chapter 3:**  
**Viewing Live Video via VLC Media Player.....37**

# PREFACE

## Copyright

This publication, including all photographs, illustrations and software, is protected under international copyright laws, with all rights reserved. No part of this manual may be reproduced, copied, translated or transmitted in any form or by any means without the prior written consent from NEXCOM International Co., Ltd.

## Disclaimer

The information in this document is subject to change without prior notice and does not represent commitment from NEXCOM International Co., Ltd. However, users may update their knowledge of any product in use by constantly checking its manual posted on our website: <http://www.nexcom.com>. NEXCOM shall not be liable for direct, indirect, special, incidental, or consequential damages arising out of the use of any product, nor for any infringements upon the rights of third parties, which may result from such use. Any implied warranties of merchantability or fitness for any particular purpose is also disclaimed.

## Acknowledgements

NCb-311 is a trademark of NEXCOM International Co., Ltd. All other product names mentioned herein are registered trademarks of their respective owners.

## Regulatory Compliance Statements

This section provides the FCC compliance statement for Class B devices and describes how to keep the system CE compliant.

## Declaration of Conformity

### FCC

This equipment has been tested and verified to comply with the limits for a Class B digital device, pursuant to Part 15 of FCC Rules. These limits are designed to provide reasonable protection against harmful interference when the equipment is operated in a commercial environment. This equipment generates, uses, and can radiate radio frequency energy and, if not installed and used in accordance with the instructions, may cause harmful interference to radio communications. Operation of this equipment in a residential area (domestic environment) is likely to cause harmful interference, in which case the user will be required to correct the interference (take adequate measures) at their own expense.

### CE

The product(s) described in this manual complies with all applicable European Union (CE) directives if it has a CE marking. For computer systems to remain CE compliant, only CE-compliant parts may be used. Maintaining CE compliance also requires proper cable and cabling techniques.

## RoHS Compliance



### **NEXCOM RoHS Environmental Policy and Status Update**

This publication, including all photographs, illustrations and software, is protected under international copyright laws, with all rights reserved. No part of this manual may be reproduced, copied, translated or transmitted in any form or by any means without the prior written consent from NEXCOM International Co., Ltd.

RoHS restricts the use of Lead (Pb) < 0.1% or 1,000ppm, Mercury (Hg) < 0.1% or 1,000ppm, Cadmium (Cd) < 0.01% or 100ppm, Hexavalent Chromium (Cr6+) < 0.1% or 1,000ppm, Polybrominated biphenyls (PBB) < 0.1% or 1,000ppm, and Polybrominated diphenyl Ethers (PBDE) < 0.1% or 1,000ppm.

In order to meet the RoHS compliant directives, NEXCOM has established an engineering and manufacturing task force to implement the introduction of green products. The task force will ensure that we follow the standard NEXCOM development procedure and that all the new RoHS components and new manufacturing processes maintain the highest industry quality levels for which NEXCOM are renowned.

The model selection criteria will be based on market demand. Vendors and suppliers will ensure that all designed components will be RoHS compliant.

### **How to recognize NEXCOM RoHS Products?**

For existing products where there are non-RoHS and RoHS versions, the suffix "(LF)" will be added to the compliant product name.

All new product models launched after January 2006 will be RoHS compliant. They will use the usual NEXCOM naming convention.

## Warnings

Read and adhere to all warnings, cautions, and notices in this guide and the documentation supplied with the chassis, power supply, and accessory modules. If the instructions for the chassis and power supply are inconsistent with these instructions or the instructions for accessory modules, contact the supplier to find out how you can ensure that your computer meets safety and regulatory requirements.

## Cautions

Electrostatic discharge (ESD) can damage system components. Do the described procedures only at an ESD workstation. If no such station is available, you can provide some ESD protection by wearing an antistatic wrist strap and attaching it to a metal part of the computer chassis.

## Safety Information

Before installing and using the device, note the following precautions:

- Read all instructions carefully.
- Do not place the unit on an unstable surface, cart, or stand.
- Follow all warnings and cautions in this manual.
- When replacing parts, ensure that your service technician uses parts specified by the manufacturer.
- Avoid using the system near water, in direct sunlight, or near a heating device.
- The load of the system unit does not solely rely for support from the rackmounts located on the sides. Firm support from the bottom is highly necessary in order to provide balance stability.
- The network camera is provided with a battery-powered real-time clock circuit. There is a danger of explosion if battery is incorrectly replaced. Replace only with the same or equivalent type recommended by the manufacturer. Discard used batteries according to the manufacturer's instructions.

## Installation Recommendations

Ensure you have a stable, clean working environment. Dust and dirt can get into components and cause a malfunction. Use containers to keep small components separated.

Adequate lighting and proper tools can prevent you from accidentally damaging the internal components. Most of the procedures that follow require only a few simple tools, including the following:

- A Philips screwdriver
- A flat-tipped screwdriver
- A grounding strap
- An anti-static pad

Using your fingers can disconnect most of the connections. It is recommended that you do not use needle-nose pliers to disconnect connections as these can damage the soft metal or plastic parts of the connectors.

## Safety Precautions

1. Read these safety instructions carefully.
2. Keep this User Manual for later reference.
3. Disconnect this equipment from any power sources before cleaning. Use a damp cloth. Do not use liquid or spray detergents for cleaning.
4. For plug-in equipment, the power outlet socket must be located near the equipment and must be easily accessible.
5. Keep this equipment away from humidity.
6. Put this equipment on a stable surface during installation. Dropping it or letting it fall may cause damage.
8. Make sure the voltage of the power source is correct before connecting the equipment to the power source.
10. All cautions and warnings on the equipment should be noted.
11. If the equipment is not used for a long time, disconnect it from the power source to avoid damage by transient overvoltage.
12. Never pour any liquid into an opening. This may cause fire or electrical shock.
13. Never open the equipment. For safety reasons, the equipment should be opened only by qualified service personnel.
14. If one of the following situations arises, get the equipment checked by service personnel:
  - a. The power cord or plug is damaged.
  - b. Liquid has penetrated into the equipment.
  - c. The equipment has been exposed to moisture.
  - d. The equipment does not work well, or you cannot get it to work according to the user's manual.
  - e. The equipment has been dropped and damaged.
  - f. The equipment has obvious signs of breakage.
15. Do not place heavy objects on the equipment.
17. CAUTION: DANGER OF EXPLOSION IF BATTERY IS INCORRECTLY REPLACED. REPLACE ONLY WITH THE SAME OR EQUIVALENT TYPE RECOMMENDED BY THE MANUFACTURER. DISCARD USED BATTERIES ACCORDING TO THE MANUFACTURER'S INSTRUCTIONS.

## Technical Support and Assistance

1. For the most updated information of NEXCOM products, visit NEXCOM's website at [www.nexcom.com](http://www.nexcom.com).
2. For technical issues that require contacting our technical support team or sales representative, please have the following information ready before calling:
  - Product name and serial number
  - Detailed information of the peripheral devices
  - Detailed information of the installed software (operating system, version, application software, etc.)
  - A complete description of the problem
  - The exact wordings of the error messages

### Warning!

1. Handling the unit: carry the unit with both hands and handle it with care.
2. Maintenance: to keep the unit clean, use only approved cleaning products or clean with a dry cloth.

## Conventions Used in this Manual



### Warning:

Information about certain situations, which if not observed, can cause personal injury. This will prevent injury to yourself when performing a task.



### Caution:

Information to avoid damaging components or losing data.



### Note:

Provides additional information to complete a task easily.



## Package Contents

The NCB-311 package contains the following accessories:

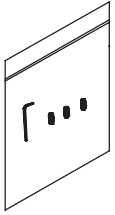

Screw Kit

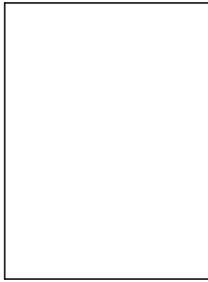

Quick guide

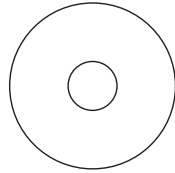

# CHAPTER 1: PRODUCT INTRODUCTION

## Overview



## Key Features

- 3MP @20fps, Full HD1080P @30fps
- Digital WDR
- DC iris
- Micro SD card slot
- Support 0°C~60°C / 32°F~140°F
- Lens optional

## Hardware Specifications

### Camera

- Image sensor: 1/3" 3megapixel progressive scan CMOS sensor
- Minimum Illumination: B/W 0.01 lux/ color 0.1 lux
- Lens: CS mount
- Iris type: DC-iris
- Day and night: Yes (true D/N)
- WDR: Yes (DWDR)
- Image Enhancement
  - Brightness, Contrast, Saturation, Sharpness, Backlight compensation, Mirror, Flip, Day/Night, Anti-flicker

### Video

- Video compression: H.264/MJPEG
- Video streaming: triple streaming
  - H.264 Stream 1/ H.264 Stream 2/ MJPEG Stream 3
- Video resolution: 2048 x 1536 to 320 x 240
- Video quality
  - VBR/ CBR
- Frame rate
  - 2048 x 1536 @ 20 fps
  - 1920 x 1080 @ 30 fps
  - 1280 x 720 @ 30 fps
  - 720 x 576 @ 30 fps
  - 720 x 480 @ 30 fps
  - 640 x 480 @ 30 fps
  - 320 x 240 @ 30 fps

### Audio

- Audio Streaming: Two-way
- Audio Compression: G.711 8KHz/ 16bit
- Audio Input: Line in
- Audio Output: Line out

### Network

- Interface: 10/100/1000 Mbps Ethernet, RJ-45
- Supported protocols: HTTP, TCP/IP, UDP, RTP, RTSP, FTP, SMTP, DHCP, DNS, DDNS, NTP, uPnP, ONVIF, IPv4/v6
- Security: Multi-level passwords/ HTTP encryption

### I/O Connector

- Audio in/ out Port: 1x 3.5mm phone jack
- D I/O: 1x DI, 1x DO
- Micro SD slot: Yes
- RJ45: Yes

### Event Management

- Event trigger: Motion detection, DI
- Notifications: Trigger alarm output, email/ FTP and record video to FTP or SD card
- Post-recording: Yes
- Pre-recording: Yes

### Power

- DC: DC 12V/AC 24V terminal block
- PoE: Yes/ IEEE 802.3at (PoE+)

### General

- Power consumption: 10W max.
- Weight: 470g
- Dimension: 126mm (D) X 73.27mm (W) X 64mm (H)
- Operating Temp.: 0°C~60°C / 32°F~140°F
- Humidity: 90% RH (no condensation)
- Certification: CE/ FCC
- Weatherproof: With housing
- Application: SDK available for application development

## Physical Descriptions

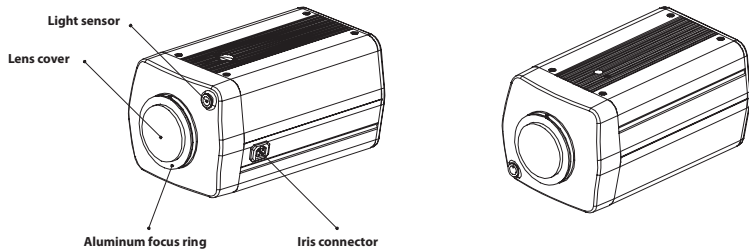

## DI/O Pinout Assignment

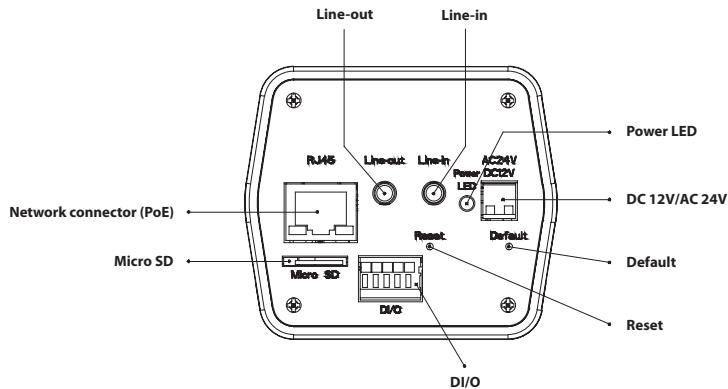
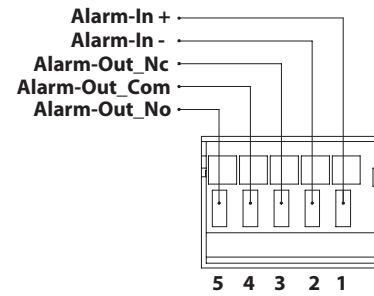

Pin	Description
1	Alarm-In +
2	Alarm-In -
3	Alarm-Out_Nc
4	Alarm-Out_Com
5	Alarm_Out_No

Note:

Default : If the default button has been pressed 1~4 secs, the camera will be re-started and all the settings will be back to default except IP address. If over 5 secs, the camera will be re-started and all the settings will be back to default including IP address.

Reset : Press to reset the camera.

## Hardware Installation

1. Remove the lens cover.
2. Attach the camera lens (purchased separately) onto the focus ring and connect it to the iris connector.
3. After adjusting the lens focus, use the supplied hex wrench to tighten the two set screws into the set screw holes on the focus ring to secure the lens. (Please refer to the figure below)

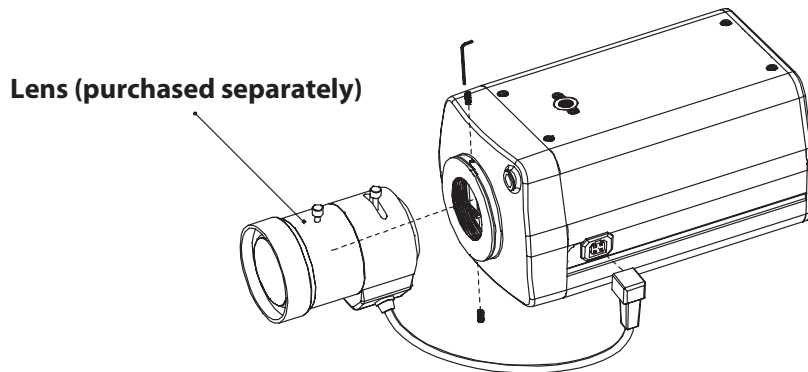

## CHAPTER 2: CAMERA CONFIGURATION

### Accessing the Camera's Configuration Menu (Graphical User Interface)

The camera's default IP address is 192.168.1.168, make sure the IP address of the computer accessing the camera is on the same network subnet before proceeding.

You can access the camera via a web browser or NexCam Assistant software included with the camera. The following information outlines the instructions for each method.

### Installing NexCam Assistant



Note: If NexCam Assistant is already installed, you can skip this section and continue to the next section **NexCAM Assistant** on page 8.

1. Locate the installation file **NexCamAssistant-Setup.msi** on the CD.
2. Once located, double click on the file to start the installation program.
3. Click the **Next** button on the welcome screen to continue.

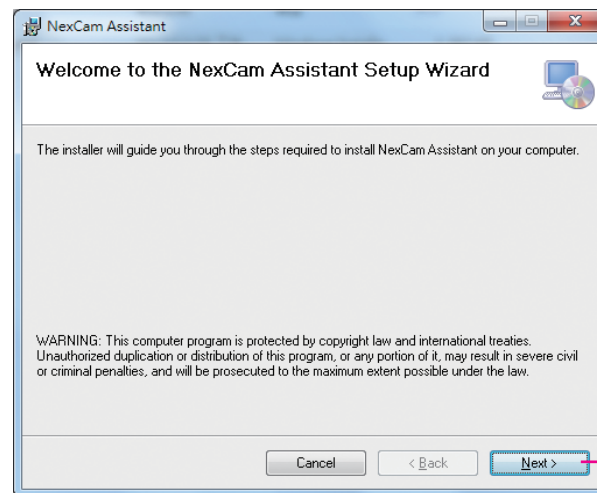

Next button

- Confirm the directory that the program will be installed on. To specify a different folder, please click on the **Browse** button and locate the desired installation folder.

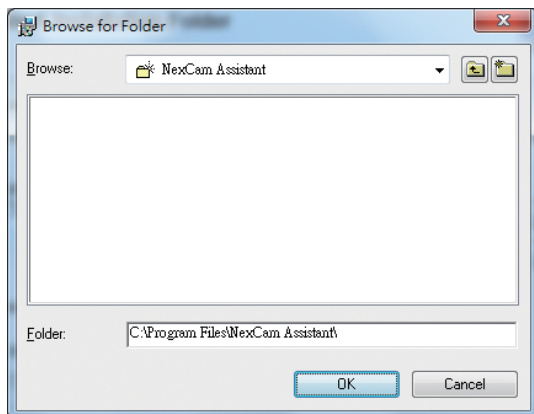

- To check the available drives you can install the software to and their available and required disk space, please click on the **Disk Cost** button.

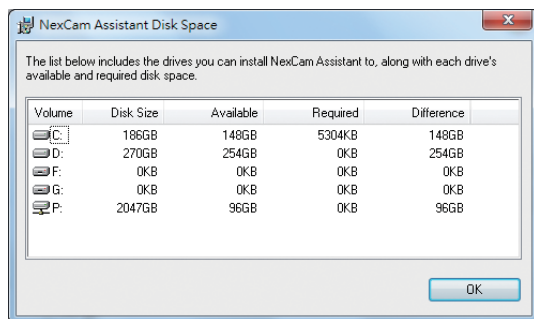

- Specify which user accounts on the computer can access the program, the options are **Everyone** and **Just me**.

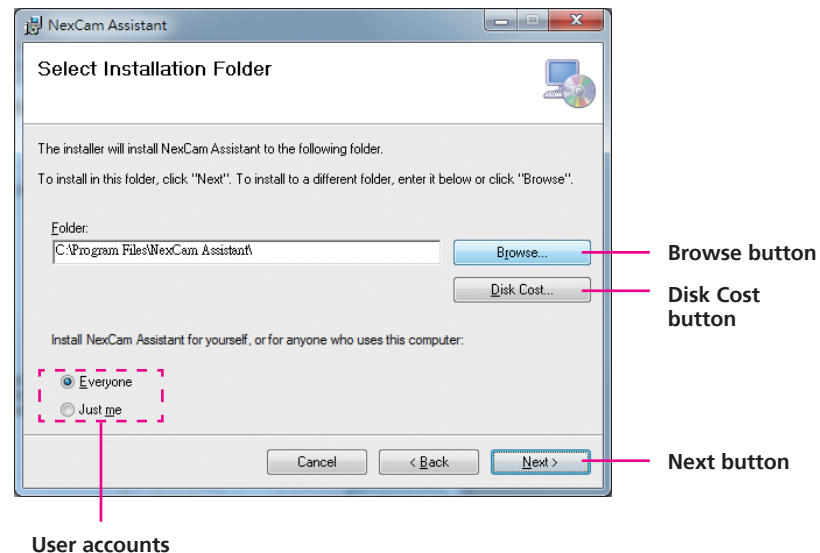

- Click on the **Next** button to continue.

8. Click on the **Next** button to begin installation.

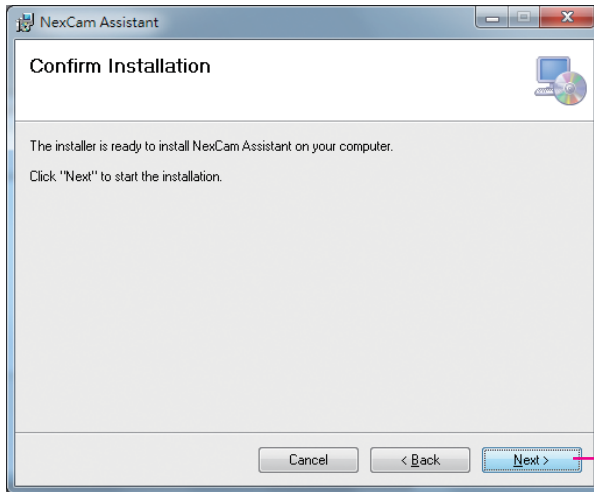

Next button

9. Once the installation process is complete, click on the **Close** button to finish. A shortcut will be created on the desktop.

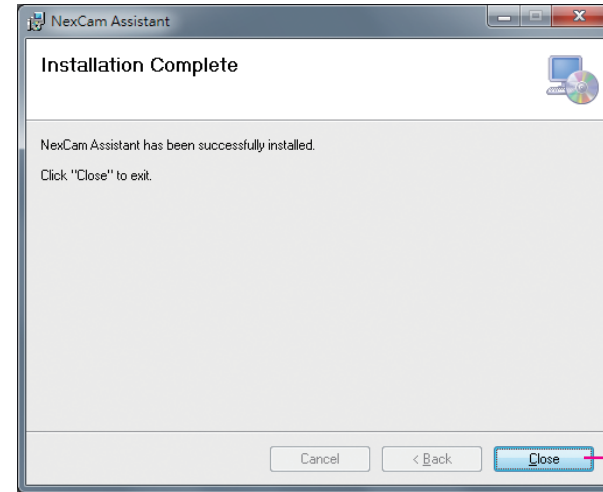

Close button



## NexCam Assistant

1. Locate and open the NexCam Assistant software shortcut on the desktop.

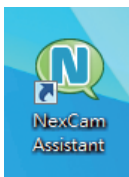

2. When the program is launched, it will begin searching the network for the IP camera automatically (the search will last for up to 90 seconds). You can also manually search cameras by clicking on the **Search** button.

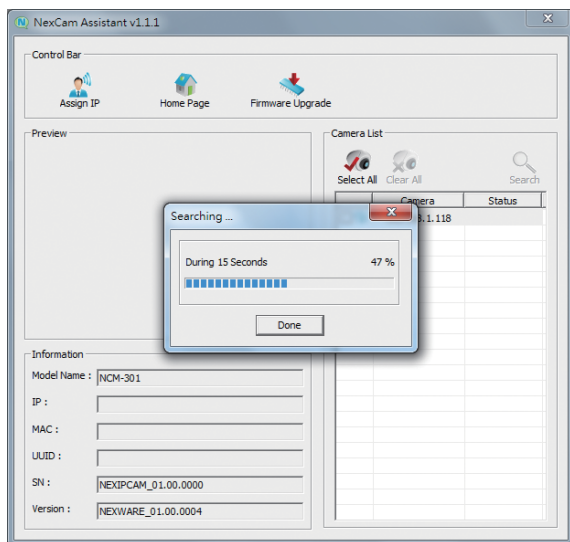

Note: Manual search will last for up to 90 seconds.

3. Once the camera is discovered, it will show the following information:
  - Model name
  - IP address
  - MAC address
  - UUID
  - Serial number
  - Version
4. Click on the **Home Page** button and it will launch the camera's configuration menu via Internet Explorer. You can also access the menu by double clicking the camera's **IP address** under **Camera List**.

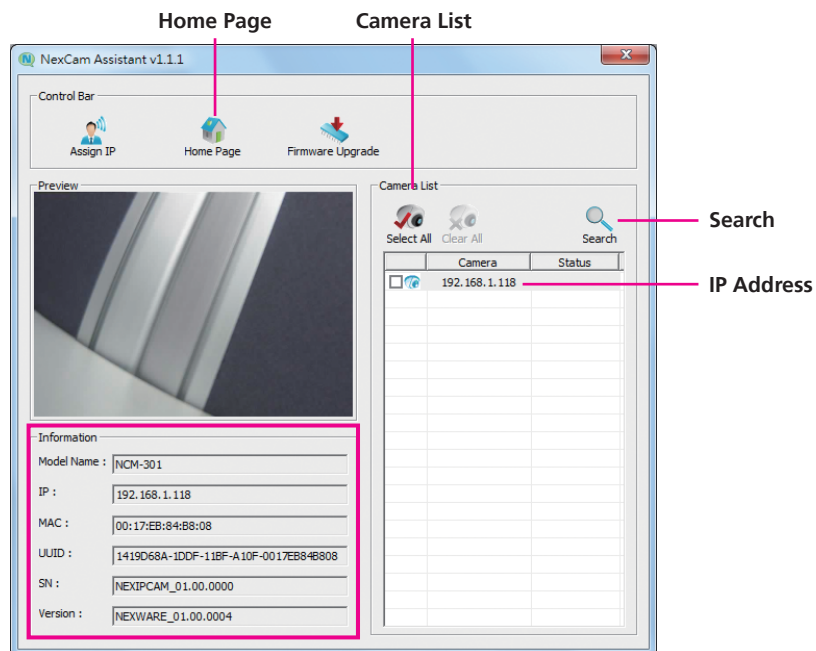

## Multiple Cameras

If more than one IP camera are detected, the **Camera List** will show all the available cameras on the network. To access all the cameras' configuration menu simultaneously, click on the **Select All** button to select all the cameras in the list, then click the **Home Page** button. Similarly, you can access specific ones by ticking the camera's checkbox.

To deselect, press the **Clear All** button to remove all the selection, or specific ones by unchecking the checkbox.

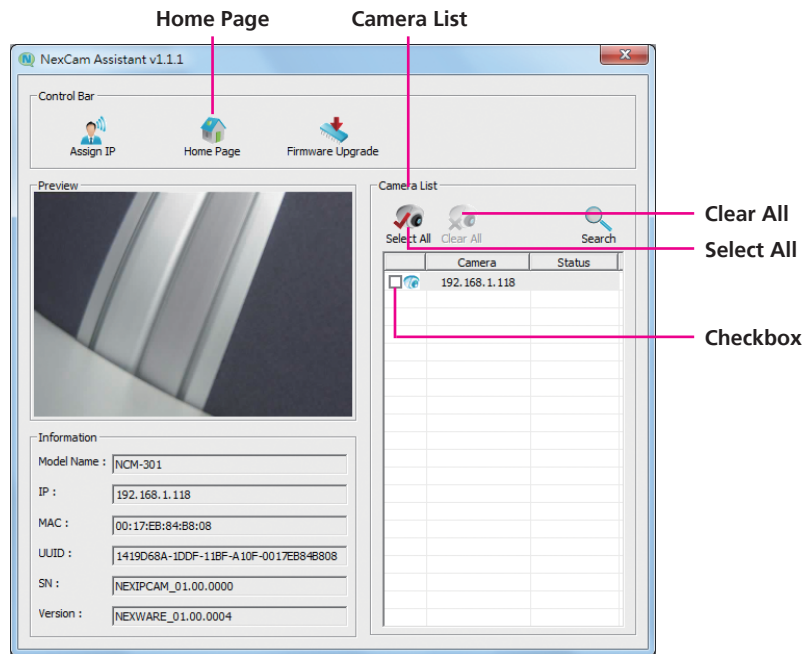

## Web Browser (Internet Explorer)

1. Locate and open the Internet Explorer (IE) shortcut on the desktop.
2. In the address bar, type 192.168.1.168 (default IP address of the camera) and then press the **Enter** button.
3. You will be prompted with a pop-up window asking for login information, type in **"admin"** (default login name) and **"9999"** (default password)
4. Once logged in, you will see the main screen with video stream [stream 3]

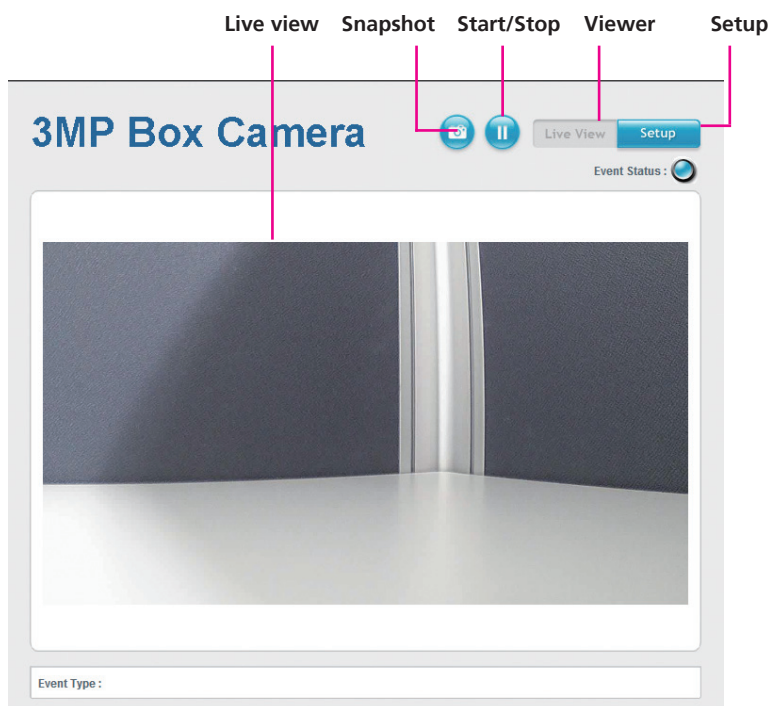

### Snapshot

Takes a image snapshot from the camera, you will be prompted to store the image file onto the computer's hard drive.

### Start/Stop

Press to stop the live video, press again to restart.

### Viewer

Views the live video of the camera.

### Setup

Options for configuring the IP camera.

## Configuring the Camera's Setting

1. To configure the camera's setting, click on the **Setup** button on the main screen to enter the configuration menu.



## Browsing Through the Configuration Menu

The layout of the configuration menu is split into two sections. All the camera settings are located on the left hand side of the interface, clicking it will open their corresponding sub-menu on the right.

**3MP Box Camera** Live View Setup

**Settings**

- Video**
  - Video Stream
  - Camera Settings
  - Overlay Settings
  - Privacy Mask
- Network**
  - TCP/IP
  - FTP
  - SMTP
  - Ports
- Events**
  - Motion Detection
  - Alarm In/Out Trigger
  - Event Actions
- System**
  - Audio Settings
  - User Management
  - SD Card Management
  - Date & Time
  - Firmware Upgrade
  - Maintenance

**Video Stream Settings**

**Stream-1**

H.264  
 Resolution: 1920x1080 (16.9)  
 FrameRate: 30 fps (Range = 5-30fps)  
 Bit Rate Control:  
 VBR  
 CBR Target bit rate: 10000 kbit/s (Range = 30-20000 kbit/s)  
 GOP Length: 1 seconds

**Stream-2**

H.264  
 Resolution: 720x480 (3.2)  
 FrameRate: 15 fps (Range = 0-30fps / Stream off = 0)  
 Bit Rate Control:  
 VBR  
 CBR Target bit rate: 2000 kbit/s (Range = 30-10000 kbit/s)  
 GOP Length: 1 seconds

**Stream-3**

MJPEG  
 Resolution: 1280x720 (16.9)  
 FrameRate: 10 fps (Range = 0-30fps / Stream off = 0)  
 Quality: Good

Save Reset

The following are the camera settings available on the left hand side:

- Video
  - Video Stream
  - Camera Settings
  - Overlay Settings
  - Privacy Mask
- Network
  - TCP/IP
  - FTP
  - SMTP
  - Ports
- Events
  - Motion Detection
  - Alarm In/Out Trigger
  - Event Actions
- System
  - Audio Settings
  - User Management
  - SD Card Management
  - Date & Time
  - Firmware Upgrade
  - Maintenance

## Video

### Video Stream

This section configures the settings of the video stream. There are 3 video streams available, the live video from the main screen **Viewer** is stream 1.

#### Video Stream Settings

**Stream-1**

H.264

Resolution :

FrameRate :  fps ( Range = 5~30fps )

Bit Rate Control :

VBR

CBR Target bit rate :  kbit/s ( Range = 30~20000 kbit/s )

GOP Length :  seconds

**Stream-2**

H.264

Resolution :

FrameRate :  fps ( Range = 0~30fps / Stream off = 0 )

Bit Rate Control :

VBR

CBR Target bit rate :  kbit/s ( Range = 30~10000 kbit/s )

GOP Length :  seconds

**Stream-3**

MJPEG

Resolution :

FrameRate :  fps ( Range = 0~30fps / Stream off = 0 )

Quality :

### Stream 1 (H.264)

#### Resolution

Configures the resolution of the video stream. The options are **2048x1536 (4:3)** and **1920x1080 (16:9)**.

#### FrameRate

Adjusts the frame rate of the video stream, the range is 5~60FPS.

#### Bit Rate Control

Configures the Bit Rate Control mode as **VBR** (variable bit rate), or **CBR** (constant bit rate) for the stream.

#### Target Bit Rate

If the Bit Rate Control is set to **CBR**, you can manually set the bit rate in this field, the range is 30~20000kbit/s.

#### GOP Length

Configures the GOP length of the stream. The options are **0.5, 1, 2, 3** and **4**, setting "**0.5 seconds**" will yield the best video quality.

## Stream 2 (H.264)

### Resolution

Configures the resolution of the video stream. The available options are **1280x720(16:9)**, **720x480(3:2)**, **720x576(5:4)**, **640x480(4:3)** and **320x240(4:3)**.

### FrameRate

Adjusts the frame rate of the video stream. Setting **0** will disable the stream.

### Bit Rate Control

Configures the Bit Rate Control mode as **VBR** (variable bit rate), or **CBR** (constant bit rate) for the stream.

### Target Bit Rate

If the Bit Rate Control is set to **CBR**, you can manually set the bit rate in this field, the range is 30~10000kbit/s.

### GOP Length

Configures the GOP length of the stream. The options are **0.5**, **1**, **2**, **3** and **4**, setting "**0.5 seconds**" will yield the best video quality.

## Stream 3 (MJPEG)

### Resolution

Displays the resolution of the video stream.

### FrameRate

Adjusts the frame rate of the video stream. Setting **0** will disable the stream.

### Quality

Configures the video quality of the stream. The options are **Best**, **Good** and **Normal**.

### Save

Save button to apply the configurations, click on this button once all the settings are confirmed for the new changes to take effect.

### Reset

Reset button to discard all the settings applied.

## Camera Settings

This section adjusts the camera's image settings.

### Camera Settings

**Image Adjustment**

Brightness:    (Range = 0~255)

Contrast:    (Range = 0~255)

Color Saturation:    (Range = 0~255)

Sharpness:    (Range = 0~255)

---

**Mirror & Flip**

Enable mirror

Enable flip

---

**White Balance**

White balance mode:

---

**Exposure**

Exposure mode:

Exposure value adjust:    (Range = 0~255)

Enable slow shutter

Max.exposure time:

Enable sens up

Max.sens up gain:

Enable backlight compensation

---

**Day & Night**

Auto

Forced color

Forced black & white

## Image Adjustments

### Brightness

Configures the brightness of the image, the range is 0 ~ 255, with 0 being the lowest brightness. Press the < button to decrease the value, or > button to increase the value. The default value is 128.

### Contrast

Configures the contrast of the image, the range is 0 ~ 255, with 0 being the lowest contrast. Press the < button to decrease the value, or > button to increase the value. The default value is 128.

### Color Saturation

Configures the color saturation of the image, the range is 0 ~ 255, with 0 being the lowest saturation. Press the < button to decrease the value, or > button to increase the value. The default value is 128.

### Sharpness

Configures the sharpness of the image, the range is 0 ~ 255, with 0 being the lowest sharpness. Press the < button to decrease the value, or > button to increase the value. The default value is 128.

### Default

Default button to discard all the settings applied to Image Adjustments.



## QuickViewer

Click this button to open up a small preview window of the live video, you can view the image as you make image adjustments. Click the **Save** button for the changes to take effect.



## Mirror & Flip

### Enable Mirror

Flip the camera image horizontally.

### Enable Flip

Flip the camera image vertically.

## White Balance

### White Balance Mode

Enables or disables the white balance function on the camera. White balance allows the camera to produce more accurate colors under different lighting conditions. The following modes can be selected:

Off:	Disables white balance function.
Auto:	Automatically adjusts the white balance to suit the current lighting condition.
Fixed Outdoor:	Adjusts the white balance for outdoor daylight.
Incandescent:	Adjusts the white balance for indoor light.
Fluorescent:	Adjusts the white balance for fluorescent light.

## Exposure

### Exposure Mode

This option configures the anti-flickering function of the camera. If the image is suffering from flickering under fluorescent light, selecting **Auto** will allow the camera to automatically adjust the light frequency to match the current fluorescent lighting condition and prevent flickering. You can also manually set it to **Anti-Flicker 50Hz**, **Anti-Flicker 60Hz** or **Locked**.

### Exposure Value Adjust

Adjusts the exposure value on the camera, the range is 0 ~ 255. Press the < button to decrease the value, or > button to increase the value. The default value is 128.

### Enable Slow Shutter

Enables or disables slow shutter on the camera, you can select the shutter speed in drop the list. The options are **1/7**, **1/15**, **1/30**. Selecting a slower shutter speed will improve image quality in low light conditions, but will increase motion blur.

### Enable Sens Up

Enables or disables gain setting on the camera, you can select the maximum level of amplification in the drop down list. The options are **4x**, **8x**, **16x** and **32x**. A higher value will produce brighter images, but may also increase image noise.

### Enable Backlight Compensation

Enables or disables backlight compensation function, enable this option if an image in the camera is too dark.

## Day & Night

Configures the day and night mode of the camera.

**Auto:** Allows the camera to automatically sense the current lighting level and determine what type of color range it should display.

**Forced Color:** Forces the camera to display color regardless of the current lighting level.

**Forced Black & White:** Forces the camera to display black & white images regardless of the current lighting level.

### Save

Save button to apply the configurations, click on this button once all the settings are confirmed for the new changes to take effect.

### Reset

Reset button to discard all the settings applied.

## Overlay Settings

This section configures the text displayed on the live video in **Viewer**.

### Overlay Settings

#### Contents

Enable date

Enable time

Enable text :

Display Camera Name

Save

Reset

## Contents

### Enable Date

Enables or disables the **Viewer** to display the current date on the bottom right corner.

### Enable Time

Enables or disables the **Viewer** to display the current time on the bottom right corner.

### Enable Text

Enables or disables the **Viewer** to display text on the bottom left corner. The text displayed can be configured in the field box.

### Display Camera Name

Enables or disables the **Viewer** to display the camera's name on the bottom left corner. The name displayed can be configured in the **Maintenance** menu. For information on **Maintenance** menu, please refer to page 36.

### Save

Save button to apply the configurations, click on this button once all the settings are confirmed for the new changes to take effect.

### Reset

Reset button to discard all the settings applied.

## Privacy Mask

This section configures which area of the live video in **Viewer** will be masked for privacy. A total of 3 privacy masks can be configured.

### Privacy Mask

#### Settings

Privacy mask color :

#### Mask Zones

- Enable mask zone 1**
- Enable mask zone 2**
- Enable mask zone 3**



## Settings

### Privacy Mask Color

Selects the color of the privacy mask. The available colors are **Black** and **White**.

## Mask Zones

You can configure up to 3 privacy masks, the instructions below illustrate how to setup 3 privacy masks.

1. Select the color of the mask in the drop down list.
2. To create the first mask, check the **Enable mask zone 1**, and on the live video screen below, select the area to mask by holding down the mouse button and drag to make a rectangular square, release the button once the desired area is covered.
3. Press the **Setting Area** button in **Enable mask zone 1** to set this area as mask.
4. You will see the selected area turn black or white, depending on which color was chosen (This example uses black as the mask color).

### Privacy Mask

#### Settings

Privacy mask color : Black ▼

#### Mask Zones

- |   |   |                                       |
|---|---|---------------------------------------|
| <input checked="" type="checkbox"/> <b>Enable mask zone 1</b> | <input type="button" value="Setting Area"/> | <input type="button" value="Remove"/> |
| <input type="checkbox"/> <b>Enable mask zone 2</b>            | <input type="button" value="Setting Area"/> | <input type="button" value="Remove"/> |
| <input type="checkbox"/> <b>Enable mask zone 3</b>            | <input type="button" value="Setting Area"/> | <input type="button" value="Remove"/> |

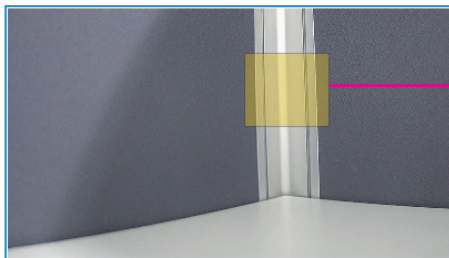

Rectangular square

#### Mask Zones

- |   |   |                                       |
|---|---|---------------------------------------|
| <input checked="" type="checkbox"/> <b>Enable mask zone 1</b> | <input type="button" value="Setting Area"/> | <input type="button" value="Remove"/> |
| <input type="checkbox"/> <b>Enable mask zone 2</b>            | <input type="button" value="Setting Area"/> | <input type="button" value="Remove"/> |
| <input type="checkbox"/> <b>Enable mask zone 3</b>            | <input type="button" value="Setting Area"/> | <input type="button" value="Remove"/> |

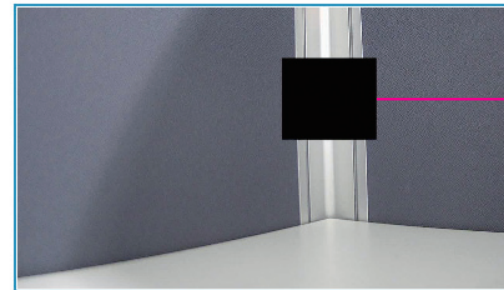

Mask area

5. To create the second and third mask, check the **Enable mask zone 2** and **Enable mask zone 3** options, then repeat steps 2 to 3 outlined earlier.

To delete a mask, check the zone number you like to remove, and press the **Remove** button.

## Network

### TCP/IP

This section configures the network settings of the camera.

#### TCP/IP

##### IP Address Configuration

Enable DHCP

Static IP address:

IP address:

Subnet Mask:

Default gateway:

Primary DNS server:

Secondary DNS server:

##### Current Network Settings

IP address: 192.168.1.168

Subnet Mask: 255.255.255.0

Default gateway: 192.168.1.254

Primary DNS server: 192.168.1.1

Secondary DNS server: 192.168.1.2

Save

Reset

### IP Address Configuration

#### Enable DHCP

Enables DHCP, use this feature if the camera is connected to a network with DHCP server.

#### Static IP Address

To manually configure an IP address, select this option and input the IP address, subnet mask, default gateway, primary and secondary DNS server address.

### Current Network Settings

Displays the current IP address, subnet mask, default gateway, primary and secondary DNS server address of the camera.

#### Save

Save button to apply the configurations, click on this button once all the settings are confirmed for the new changes to take effect.

#### Reset

Reset button to discard all the settings applied.

## FTP

This section configures the FTP server address that the camera will connect to.

### FTP

**FTP Server**

Host name or IP address :

Upload path :

Port Number :

**Login Information**

User Name :

Password :

**Test Remote FTP server**

Server status :

## FTP Server

### Host Name or IP Address

Specify the host name or IP address of the FTP server.

### Upload Path

Specify the directory that the camera will upload data to.

### Port Number

Specify the port number of the FTP server.

## Login Information

### Username

Specify the login username for the FTP server.

### Password

Specify the login password for the FTP server.

## Test Remote FTP Server

### Server Status:

Displays the status of the test connection.

### FTP Test

Tests the network connection between the camera and FTP server.

### Save

Save button to apply the configurations, click on this button once all the settings are confirmed for the new changes to take effect.

### Reset

Reset button to discard all the settings applied.

## SMTP

This section configures the SMTP mail server address that the camera will use for sending emails.

### SMTP

#### SMTP Server

Mail server :  (Host name or IP address)

Port Number :

#### Login Information

User Name :

Password :

Email address from :

#### To Mail Address

Mail address :

Mail Test Status :

## SMTP Server

### Mail Server

Specify the host name or IP address of the SMTP mail server.

### Port Number

Specify the port number of the SMTP mail server.

## Login Information

### Username

Specify the login username for the SMTP mail server.

### Password

Specify the login password for the SMTP mail server.

### Email Address From

Specify the email address of the sender.

### To Mail Address List

#### Mail Address

Specify the email address to send the email when an event is triggered by motion detection. Press the **Mail Test** button to test the connection to this email.

### Save

Save button to apply the configurations, click on this button once all the settings are confirmed for the new changes to take effect.

### Reset

Reset button to discard all the settings applied.



## Ports

This section configures the HTTP port number of the web configuration menu and RTSP port number of stream 1 to 3.

### Alarm In Out Actions

#### Alarm In Control

Alarm In mode

Alarm In Level

#### Alarm Out Control

Alarm Out mode

Alarm Out level



## HTTP

### HTTP Port

Configures the HTTP port number of the web configuration menu.

## RTSP

### Stream 1 to 3 RTSP Port

Configures the RTSP port number of stream 1 to 3, and displays the URL of stream 1 to 3. The range is 1025~65535.

Default URL of Stream 1: rtsp://camerap:554/live/stream1

Default URL of Stream 2: rtsp://camerap:8556/live/stream2

Default URL of Stream 3: rtsp://camerap:8555/live/stream3

### Save

Save button to apply the configurations, click on this button once all the settings are confirmed for the new changes to take effect.

### Reset

Reset button to discard all the settings applied.

## Events

### Motion Detection

This section configures which area of the live video in **Viewer** will be monitored for detecting motion.

#### Motion Detection

##### Settings

Enable motion detection

Sensitivity :  (Range : 1~100)

##### Detection Zones

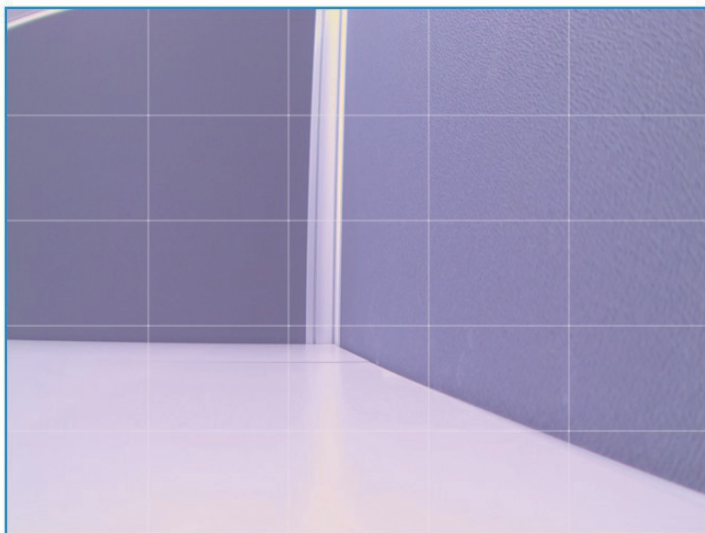

Save

Reset

## Settings

### Enable Motion Detection

Enables or disables motion detection function.

### Sensitivity

Configures the sensitivity of motion detection, the sensitivity determines the amount of motion required to trigger an event, the range is 1 to 100, with 1 being the least sensitive. For more information on event, please refer to **Event Actions** on page 28.

## Detection Zones

This section shows the live video from the camera, the screen is divided into 5x5 rectangular boxes, to setup motion detection, please follow the instructions below.

1. Check the **Enable motion detection** option, and specify the sensitivity level.
2. In the live video screen below, select the desired area for motion detection by clicking on the rectangular box. The border of the box will turn red indicating that it is selected. You can select multiple boxes, up to 5x5 boxes can be selected.
3. Press the **Save** button once all the desired areas are selected for the changes to take effect.

### Motion Detection

**Settings**

Enable motion detection  
Sensitivity :  (Range : 1~100)

**Detection Zones**



Highlighted  
box

### Motion Detection

**Settings**

Enable motion detection  
Sensitivity :  (Range : 1~100)

**Detection Zones**

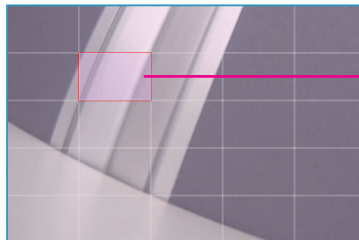

Area with  
motion detect  
enabled

To remove motion detection from an area, click the box to deselect it, then press the **Save** button for the changes to take effect.

## Alarm In/Out Trigger

This section configures the IP camera to work with external alarm in/out devices.

### Alarm In Out Actions

#### Alarm In Out Control

Alarm In mode

Disable ▾

Alarm In Level

Low ▾

Alarm Out mode

User mode ▾

Alarm Out level

Low ▾

Save

Reset

## Alarm In Out Actions

### Alarm In Mode

Enables or disables monitoring of alarm input. Enables this option if an external sensor device connected to the alarm input requires monitoring.

### Alarm In Level

Specify the signal level required for triggering the alarm device connected to the alarm output. The options are **Low** and **High**.

### Alarm Out Mode

Specify the alarm out mode, the options are **User Mode** and **Event Mode**. When **User Mode** is selected, the alarm output will be triggered based on user configurations. When **Event Mode** is selected, the alarm output will be triggered based on the configurations set in **Event Actions**. For more information on **Event Actions**, please refer to page 28.

### Alarm Out Level

Specify the alarm output action to perform when it is triggered. The options are **Low** and **High**.

### Save

Save button to apply the configurations, click on this button once all the settings are confirmed for the new changes to take effect.

### Reset

Reset button to discard all the settings applied.

## Event Actions

This section configures what actions to perform when motion detection or alarm in is triggered.

### Event Actions

#### When Motion Detection Triggered...

- Save stream to SD card  
File format:
- Upload stream to FTP server  
File format:
- Send email notification
- Alarm Output

#### When Alarm In Triggered...

- Save stream to SD card  
File format:
- Upload stream to FTP server  
File format:
- Send email notification
- Alarm Output



## When Motion Detection Triggered

### Save Stream to SD Card

Check this option to store the video stream onto the SD card. Select the desired file format in the drop down menu, the options are **AVI** and **JPEG**.

### Upload Stream to FTP Server

Check this option to upload the video stream to a FTP server. Select the desired file format in the drop down menu, the options are **AVI** and **JPEG**. For information on configuring the FTP server, please refer to **FTP** on page 22.

### Send Email Notification

Check this option to send an email notifying the event, for more information on configuring the email address, please refer to **SMTP** on page 23.

### Alarm Output

Check this option to activate the device connected to alarm output when motion detection is triggered.

## When Alarm In Triggered

### Save Stream to SD Card

Check this option to store the video stream onto the SD card. Select the desired file format in the drop down menu, the options are **AVI** and **JPEG**.

### Upload Stream to FTP Server

Check this option to upload the video stream to a FTP server. Select the desired file format in the drop down menu, the options are **AVI** and **JPEG**. For information on configuring the FTP server, please refer to **FTP** on page 22.

### **Send Email Notification**

Check this option to send an email notifying about the alarm event, for more information on configuring the email address, please refer to **SMTP** on page 23.

### **Alarm Output**

Check this option to activate the device connected to alarm output when alarm in is triggered.

### **Save**

Save button to apply the configurations, click on this button once all the settings are confirmed for the new changes to take effect.

### **Reset**

Reset button to discard all the settings applied.

## System

### Audio

This section is used to configure the audio settings.

#### Audio

##### Audio Settings

Audio In Enable

Audio In Volume :  ( Range = 1~100 )

Audio Out Enable

Audio Out Volume :  ( Range = 1~100 )

Save

Reset

### Audio Settings

#### Audio In Enable

Enables or disables audio-in on the camera. When enabled, specify the volume in the **Audio In Volume** textbox. The range is 1~100.

#### Audio Out Enable

Enables or disables audio-out on the camera. When enabled, specify the volume in the **Audio Out Volume** textbox. The range is 1~100.

#### Save

Save button to apply the configurations, click on this button once all the settings are confirmed for the new changes to take effect.

#### Reset

Reset button to discard all the settings applied.

## User Management

This section is used to manage user accounts for accessing the IP camera's web configuration menu.

### User Management

#### Add / Modify User Accounts

User Name	Password	Confirm Password	Authority	User Information
<input type="text"/>	<input type="password"/>	<input type="password"/>	Operator ▾	<input type="text"/>

(Username and password must be for least 1 characters.)

#### User List

User Name	User Group	User Information	Edit User	Delete User
admin	Administrator	Administrator	<input type="button" value="Edit"/>	



## Add/Modify User Accounts

To add a user account, type in the username and password (username and password must be at least 1 character), retype the password to confirm, then choose the access level for the account in the **Authority** drop down list. You can also provide a description for the account under the **User Information** field.

### Access Level

**Administrator:** Has full control (read/write) over every configuration menu item.

**Operator:** Has full control (read/write) over every configuration menu item in **Video** and **Event** only.

**Viewer:** Only has access (read) to the live view of the camera (main screen).

### User List

Displays user accounts available on the camera, to edit an account's password, click the **Edit** button, then retype the new password in the **Password** and **Confirm Password** fields.

### Save

Save button to apply the configurations, click on this button once all the settings are confirmed for the new changes to take effect.

### Reset

Reset button to discard all the settings applied.



## SD Card Management

This section is used to manage the SD card.

### SD Card Management

#### SD Card Information

Format

SD card is unavailable

SD card available : NO SD

SD card use% : NO SD

SD Card Overwrite :  OFF  ON

Save

#### File List

Folder Name

Filename	Date	Time	Size	Action
----------	------	------	------	--------

## SD Card Information

If a SD card is installed, this section will display information on the availability of the SD card, and the percentage of the total storage used.

### Format

Formats the SD card, all data stored on the SD card will be erased if this option is used.

### SD Card Overwrite

Enables or disables overwrite protection for the SD card. Press the **Save** button to apply the setting.

### File List

Displays the information of the folders and files stored in the SD card.

## Date & Time

This section configures the date and time on the camera.

### Date & Time

#### Current Camera Time

Date : 2011/05/11 Wed

Time : 13:27:52

#### Time Settings

Time mode :

Synchronize with NTP server

Synchronize with computer time

Manually setting

Date :  /  /  Time :  :  :

Time zone :

Daylight saving

Date :  /  /  Time :  :   [ Start ]

Date :  /  /  Time :  :   [ End ]

#### Date & Time Format

Date format :

Time format :

#### NTP Server

NTP server address :  (Host name or IP address)

Save

Reset

## Current Camera Time

Displays the current date and time on the camera.

## Time Settings

### Synchronize with NTP Server

Select this option to synchronize the date and time with a NTP server.

### Synchronize with Computer Time

Select this option to synchronize the date and time to the computer connected to the camera.

### Manually Setting

Select this option to manually configure the date and time.

### Time Zone

Select the time zone relevant to your location in the drop down list.

### Daylight Saving

Select this option to enable daylight saving. The Start/End date and time for daylight saving can be manually configured in the text boxes beneath the option.

## Date & Time Format

### Date Format

Configures the format that the date will be displayed in. The options are **YYYY/MM/DD**, **MM/DD/YYYY** and **DD/MM/YYYY**.

### Time Format

Configures the format that the time will be displayed in. The options are **12Hrs** and **24Hrs**.

## NTP Server

### NTP Server Address

If **Synchronize with NTP Server** is selected as the time mode, type in the host name or IP address of the NTP server.

### Save

Save button to apply the configurations, click on this button once all the settings are confirmed for the new changes to take effect.

### Reset

Reset button to discard all the settings applied.

## Firmware Upgrade

This section is used to update the IP camera's firmware.

### Firmware Upgrade

**Firmware Version**

Application version: NexWare\_01.00.0000

**Update**

Specify the firmware image file to upgrade:

## Firmware Version

### Application Version

Displays the current firmware version.

## Update

### Specify the Firmware Image File to Upgrade

To update the camera's firmware, click on the **Browse** button and locate the firmware image file, once the file is selected, press the **Update** button to begin.



The firmware update process will take around 15 minutes to complete, during this time, do not disconnect the network cable, reset or power off the IP camera, as you may damage the device.

## Maintenance

This section is used to restart the IP camera, or restore it to factory default settings.

### Maintenance

#### Maintain

Reboot the camera.

Reset all camera parameters to the factory default settings.

#### Camera Name Settings

Camera Name :

#### DC-Iris Calibration

Choose to use DC-Iris Lens

Status :

## Maintain

### Restart

Click this button to reboot the camera.

### Reset to Default

Click this button to restore all the camera's setting back to factory default.

## Camera Name Settings

### Camera Name

Specify a name for the camera. The name will be displayed in the upper left corner on the live video stream of the camera. To enable this, make sure the option **Display Camera Name** in the **Overlay Settings** menu is checked. For information on the **Overlay Settings** menu, please refer to page 18.

### Save

Save button to apply the configurations, click on this button once all the settings are confirmed for the new changes to take effect.

### Reset

Reset button to discard all the settings applied.

### DC-Iris Calibration

Press the button to start the DC-Iris Calibration.

## CHAPTER 3: VIEWING LIVE VIDEO VIA VLC MEDIA PLAYER

The IP camera's live video can be viewed by third party media players such as VLC media player by VideoLAN project [<http://www.videolan.org/>].

To stream the live video from the camera to VLC media player through the network, please follow the instructions below.

1. Locate and open VLC media player.
2. Go to **Media** -> **Open Network Stream**.
3. Enter the following RTSP URL:

*rtsp://192.168.1.168:8557/live/stream1*

Note: RTSP URL of stream 1, similarly you can view stream 2 and 3 of the camera by entering their corresponding URLs. Please refer to **Ports** on page 24 for more information on the URL link.

4. Press the **Play** button to start streaming.

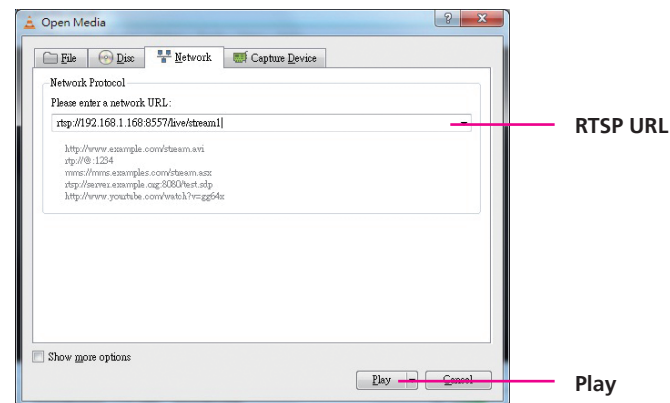

1. You will be prompted with a pop-up window asking for login information, type in "admin" (default login name) and "9999" (default password)

