



**NEXCOM International Co., Ltd.**

**IoT Automation Solutions Business Group**

**Industrial Panel PC**

**IPPC 1560T/1960T/2160P Series and APPC 1560T**

**User Manual**

# Contents

## Preface

Copyright .....	v
Disclaimer .....	v
Acknowledgements .....	v
Regulatory Compliance Statements .....	v
Declaration of Conformity .....	v
RoHS Compliance .....	vi
Warranty and RMA .....	vii
Safety Information .....	x
Installation Recommendations .....	x
Safety Precautions .....	xi
Technical Support and Assistance .....	xii
Conventions Used in this Manual .....	xii
Global Service Contact Information .....	xiii
Package Contents .....	xv
Ordering Information .....	xvii

## Chapter 1: Product Introduction

IPPC 1560T Series .....	1
Specifications .....	2
IPPC 1960T Series .....	4
Specifications .....	5
IPPC 2160P .....	7
Specifications .....	8
APPC 1560T .....	10

Specifications .....	11
Knowing Your IPPC 1560T Series .....	13
IPPC 1560TP2E-DC Rear Top .....	13
IPPC 1560TP2E-DC Rear Bottom .....	13
IPPC 1560TP2E-AC Rear Bottom .....	14
IPPC 1560TP2E-AC Rear Top .....	14
IPPC 1560TE Rear Bottom .....	16
IPPC 1560TE Rear Top .....	16
Knowing Your IPPC 1960T Series .....	17
IPPC 1960TP2E-DC Rear Top .....	17
IPPC 1960TP2E-DC Rear Bottom .....	17
IPPC 1960TP2E-AC Rear Bottom .....	18
IPPC 1960TP2E-AC Rear Top .....	18
Knowing Your IPPC 2160P .....	20
IPPC 2160P Rear Top .....	20
IPPC 2160P Rear Bottom .....	20
Knowing Your APPC 1560T .....	22
APPC 1560T Rear Top .....	22
APPC 1560T Rear Bottom .....	22
IPPC 1560T Series Rear .....	23
IPPC 1960T Series Rear .....	24
IPPC 2160P Rear .....	25
APPC 1560T Rear .....	26
Mechanical Dimensions .....	27
IPPC 1560TP2E-DC .....	27

IPPC 1560TP2E-AC .....	28
IPPC 1560TE .....	29
IPPC 1960TP2E-DC .....	30
IPPC 1960TP2E-AC .....	31
IPPC 2160P .....	32
APPC 1560T .....	33

## Chapter 2: Jumpers and Connectors

Before You Begin .....	34
Precautions .....	34
Jumper Settings .....	35
Locations of the Jumpers and Connectors .....	36
Jumpers and DIP Switch Settings .....	37
AT/ATX Power Type Select .....	37
LCD Power Select .....	37
CCFL Power Select .....	38
Touch Panel Type Select .....	38
CMOS Clear Select .....	39
RI Feature Selection (COM1) .....	39
RI Feature Selection (COM2) .....	40
RI Feature Selection (COM3) .....	40
RI Feature Selection (COM4) .....	41
Dimming Type Select .....	41
LVDS Resolution Select .....	42
PWN Reverse/Function Key Dimming Select .....	42
Connector Pin Definitions .....	43
External I/O Interfaces .....	43
Keyboard/Mouse Ports .....	43
COM 1 and COM 2 Ports .....	43
COM 3 and VGA Port .....	44
LAN 1 and USB Ports .....	44
LAN 2 and USB Ports .....	45

Audio Connectors .....	45
Connector Pin Definitions .....	46
Internal Connectors .....	46
PoE Power Connector .....	46
Power Button .....	46
DC Power Button (AT) .....	47
COM 4 .....	47
COM 5 .....	48
COM 6 .....	48
USB Connectors .....	49
Speaker-out Connector .....	49
CFast Card Slot .....	50
SATA Connector .....	50
SATA Connector .....	51
SATA Power Connector .....	51
SATA Power Connector .....	52
LVDS Connector A .....	52
LVDS Connector B .....	53
LVDS Panel Inverter Connector .....	53
Touch Panel Control Connector .....	54
SATA/Power LED .....	54
MCU Debug I/F .....	55
MCU LED Indicator Connector .....	55
Function Key-in Connector .....	56
System FAN2 Connector .....	56
System FAN1 Connector .....	57
Reset Button .....	57
Bluetooth Connector .....	58
Digital I/O .....	58
GPIO .....	59
Bluetooth Connector .....	59
Parallel Port Box Header .....	60



Mini-PCIe Connector.....	61
Mini-PCIe Connector.....	62

## Chapter 3: System Setup

Installing a Primary SATA Hard Drive .....	63
Installing a Secondary SATA Hard Drive .....	67
Installing a CFast Card .....	70
Installing a Mini-PCIe Module.....	72
Installing a Riser Card.....	87
Installing a PCI Card.....	92
Installing a CPU and SO-DIMM.....	94
Panel Mounting .....	98

## Chapter 4: BIOS Setup

About BIOS Setup.....	100
When to Configure the BIOS.....	100
Default Configuration .....	101
Entering Setup .....	101
Legends.....	101
BIOS Setup Utility.....	103
Main .....	103
Advanced .....	104
Chipset.....	115
Boot.....	119
Security .....	121
Save & Exit .....	121

## Appendix A: GPI/O Programming Guide.....122

## Appendix B: Watchdog Timer Setting.....124



# Preface

## Copyright

This publication, including all photographs, illustrations and software, is protected under international copyright laws, with all rights reserved. No part of this manual may be reproduced, copied, translated or transmitted in any form or by any means without the prior written consent from NEXCOM International Co., Ltd.

## Disclaimer

The information in this document is subject to change without prior notice and does not represent commitment from NEXCOM International Co., Ltd. However, users may update their knowledge of any product in use by constantly checking its manual posted on our website: <http://www.nexcom.com>. NEXCOM shall not be liable for direct, indirect, special, incidental, or consequential damages arising out of the use of any product, nor for any infringements upon the rights of third parties, which may result from such use. Any implied warranties of merchantability or fitness for any particular purpose is also disclaimed.

## Acknowledgements

IPPC 1560T/1960T/2160P and APPC 1560T are trademarks of NEXCOM International Co., Ltd. All other product names mentioned herein are registered trademarks of their respective owners.

## Regulatory Compliance Statements

This section provides the FCC compliance statement for Class A devices and describes how to keep the system CE compliant.

## Declaration of Conformity

### FCC

This equipment has been tested and verified to comply with the limits for a Class A digital device, pursuant to Part 15 of FCC Rules. These limits are designed to provide reasonable protection against harmful interference when the equipment is operated in a commercial environment. This equipment generates, uses, and can radiate radio frequency energy and, if not installed and used in accordance with the instructions, may cause harmful interference to radio communications. Operation of this equipment in a residential area (domestic environment) is likely to cause harmful interference, in which case the user will be required to correct the interference (take adequate measures) at their own expense.

### CE

The product(s) described in this manual complies with all applicable European Union (CE) directives if it has a CE marking. For computer systems to remain CE compliant, only CE-compliant parts may be used. Maintaining CE compliance also requires proper cable and cabling techniques.

## RoHS Compliance



### **NEXCOM RoHS Environmental Policy and Status Update**

NEXCOM is a global citizen for building the digital infrastructure. We are committed to providing green products and services, which are compliant with European Union RoHS (Restriction on Use of Hazardous Substance in Electronic Equipment) directive 2011/65/EU, to be your trusted green partner and to protect our environment.

RoHS restricts the use of Lead (Pb) < 0.1% or 1,000ppm, Mercury (Hg) < 0.1% or 1,000ppm, Cadmium (Cd) < 0.01% or 100ppm, Hexavalent Chromium (Cr6+) < 0.1% or 1,000ppm, Polybrominated biphenyls (PBB) < 0.1% or 1,000ppm, and Polybrominated diphenyl Ethers (PBDE) < 0.1% or 1,000ppm.

In order to meet the RoHS compliant directives, NEXCOM has established an engineering and manufacturing task force to implement the introduction of green products. The task force will ensure that we follow the standard NEXCOM development procedure and that all the new RoHS components and new manufacturing processes maintain the highest industry quality levels for which NEXCOM are renowned.

The model selection criteria will be based on market demand. Vendors and suppliers will ensure that all designed components will be RoHS compliant.

### **How to recognize NEXCOM RoHS Products?**

For existing products where there are non-RoHS and RoHS versions, the suffix "(LF)" will be added to the compliant product name.

All new product models launched after January 2013 will be RoHS compliant. They will use the usual NEXCOM naming convention.

## Warranty and RMA

### NEXCOM Warranty Period

1. NEXCOM makes products in accordance with the Industry standard and, NEXCOM warrants that all her Industry-grade IPC and System products will be free from defect in neither material nor workmanship for twenty-four (24) months from the day of invoice issued.
2. For NEXCOM Panel PC product lines (the APPC, MPPC series), they are also guaranteed against defect in materials and workmanship for the period of twenty-four (24) months in their motherboard design. For 3rd party parts, it follows with original suppliers' standard: 12 months for battery pack and LCD, 24 months for adaptor / add on modules (including GSM module, RFID module, and antenna).
3. If NEXCOM determines customer's warranty claim is valid, NEXCOM will repair or replace product(s) without additional charge for parts and labor. An extended Warranty Program will extend the warranty period of the product accordingly.

### Warranty Coverage

The warranty applies only to products manufactured or distributed by NEXCOM and her subsidiaries. This warranty covers all the products/shipments except for:

1. Any claimed defect, products that have been repaired or modified by persons who have not been authorized by NEXCOM or, products which have been subjected to misuse, abuse, accident, improper installation, or usage not in accordance with the product instruction. NEXCOM assumes no liability as a consequence of such events under the term of this warranty.

One example is the replacement of Tablet's or Hand-held's LCD display due to scratching stains or other degradation; these will not be covered under this warranty.

2. Damages caused by customers' delivery/shipping of the product or, product failure resulted from electrical power/voltage shock, or, installation of parts/components which are not supplied/approved by NEXCOM in advance.
3. Third-party products:
  - a. Software, such as the device drivers,
  - b. External devices such as HDD, printer, scanner, mouse, LCD panel, battery, and so on,
  - c. Accessory/parts that were not approved by NEXCOM and,
  - d. Accessory/parts were added to products after they were shipped from NEXCOM.

Product will be treated as "Out of Warranty " if:

- a. It expires the warranted 24 months period from the day it was purchased.
- b. It had been altered by persons other than an authorized NEXCOM service person or, which have been subjected to misuse, abuse, accident, or improper installation.
- c. It doesn't have the original NEXCOM Serial Number labeling for NEXCOM's warranty period identification or, tracking.

RMA that NEXCOM has determined not to be covered by the warranty will be charged the NEXCOM Standard Repair Fee for the repairing. If a RMA is determined to be not repairable, customer will be notified and product(s) may be returned to customer at their request; a minimum service fee may be charged however.

### **NEXCOM Return Merchandise Authorization (RMA) Procedure**

For the RMA (Return Merchandise Authorization) shipment, customer is responsible for packaging and shipping the product to the designated NEXCOM service sites, with shipping charges prepaid by the customer. The original NEXCOM shipping box should be used whenever possible. NEXCOM shall pay for the return of the product to the customer's location. In case of expedited shipping request, an extra service charge shall be assessed and the customer is responsible for this extra return shipping charge.

1. Customers should enclose the "NEXCOM RMA Service Form" with the returned products.
2. Customers need to write down all the information related to the problem on the " NEXCOM RMA Service Form " when applying for the RMA service; information will help to understand the problem, including the fault description, on-screen messages, and pictures if possible.
3. Customers could send back the faulty product with or without the accessories and key parts such as the CPU and DIMM. If the key parts are included, please be noted clearly within the return form. NEXCOM takes no responsibility for the parts which are not listed in the return form.
4. Customers hold the responsibility to ensure that the packing of defective products is durable enough to be resistant against further damage due to the transportation; damage caused by transportation is treated as " Out of Warranty " under our Warranty specification.
5. RMA product(s) returned by NEXCOM to any location other than the

customer registered delivery address will incur an extra shipping charge, the customer is responsible for paying the extra shipping charges, duties, and taxes of this shipment.

### **Product Repairing**

1. NEXCOM will repair defective products covered under this limited warranty that are returned to NEXCOM; if products do prove to be defective, they will be repaired during their warranty period unless other warranty terms have been specified.
2. NEXCOM owns all parts removed from repaired products.
3. NEXCOM will use parts made by various manufacturers in performing the repair.
4. The repaired products will be warranted subjected to the original warranty coverage and period only.
5. For products returned as defective but, proved to be no defect/fault after the RMA process, NEXCOM reserves the right to claim for a NDF (No Defect Found) Service Charge.
6. NEXCOM will issue RMA Report which included Repair Detailed Information to the customer when the defective products were repaired and returned.
7. In addition to the above, NEXCOM may authorize Independent/Third-party suppliers to repair the defective products for NEXCOM.

## Out Of Warranty Service

There will be a service charge from NEXCOM for the “Out Of Warranty” product service; they are the Basic Diagnostic Service Fee and the Advanced Component Replacement Fee respectively. And, if the product can not be repaired, NEXCOM will either return the product to the customer or, just scrap it, followed by customer’s instruction.

### 1. Testing and Parts Replacement

NEXCOM will have the following Handling Charges for those OoW products that returned:

- a. Basic Labor Cost and Testing Fee: as Table listed.
  - b. Parts Fee: NEXCOM will charge for main IC chipsets such as the N.B., S.B., Super-IO, LAN, Sound, Memory, and so on.
  - c. 3rd-party Device Fee: products replacement for CPU, DIMM, HDD, Chassis, and UPS.
2. Out of Warranty product will have a three months warranty for the fixed issues. If the product failed with different problem within 3 months, they will still incur the service charge of “Out of Warranty” .
3. Out of Warranty “products will not be repaired without a signed PI from the customer, the agreement of the repair process.

Add-on card, 3rd Party Device and board level repair cost higher than new product prices, customer can abandon to sign PI to repair and, please contact with sales to buy new products.

## Safety Information

Before installing and using the device, note the following precautions:

- Read all instructions carefully.
- Do not place the unit on an unstable surface, cart, or stand.
- Follow all warnings and cautions in this manual.
- When replacing parts, ensure that your service technician uses parts specified by the manufacturer.
- Avoid using the system near water, in direct sunlight, or near a heating device.
- The load of the system unit does not solely rely for support from the rackmounts located on the sides. Firm support from the bottom is highly necessary in order to provide balance stability.
- Maximum surrounding air temperature should not exceed 50°C.
- For use in Pollution Degree 2 Environment.
- Follow all mounting guidelines and instructions on Chapter 3 of the manual.
- Suitable for mounting on the flat surface of Type 2 and Type 4X indoor use only enclosure.

Caution:

FOR USE IN A CONTROLLED ENVIRONMENT, REFER TO MANUAL FOR ENVIRONMENTAL CONDITIONS.



Attention:

POUR UTILISATION EN ATMOSPHERE CONTROLEE, CONSULTER LA NOTICE TECHNIQUE.

## Installation Recommendations

Ensure you have a stable, clean working environment. Dust and dirt can get into components and cause a malfunction. Use containers to keep small components separated.

Adequate lighting and proper tools can prevent you from accidentally damaging the internal components. Most of the procedures that follow require only a few simple tools, including the following:

- A Philips screwdriver
- A flat-tipped screwdriver
- A grounding strap
- An anti-static pad

Using your fingers can disconnect most of the connections. It is recommended that you do not use needle-nose pliers to disconnect connections as these can damage the soft metal or plastic parts of the connectors.

## Safety Precautions

1. Read these safety instructions carefully.
2. Keep this User Manual for later reference.
3. Disconnect this equipment from any AC outlet before cleaning. Use a damp cloth. Do not use liquid or spray detergents for cleaning.
4. For plug-in equipment, the power outlet socket must be located near the equipment and must be easily accessible.
5. Keep this equipment away from humidity.
6. Put this equipment on a stable surface during installation. Dropping it or letting it fall may cause damage.
7. The openings on the enclosure are for air convection to protect the equipment from overheating. **DO NOT COVER THE OPENINGS.**
8. Make sure the voltage of the power source is correct before connecting the equipment to the power outlet.
9. Place the power cord in a way so that people will not step on it. Do not place anything on top of the power cord. Use a power cord that has been approved for use with the product and that it matches the voltage and current marked on the product's electrical range label. The voltage and current rating of the cord must be greater than the voltage and current rating marked on the product.
10. All cautions and warnings on the equipment should be noted.
11. If the equipment is not used for a long time, disconnect it from the power source to avoid damage by transient overvoltage.
12. Never pour any liquid into an opening. This may cause fire or electrical shock.
13. Never open the equipment. For safety reasons, the equipment should be opened only by qualified service personnel.
14. If one of the following situations arises, get the equipment checked by service personnel:
  - a. The power cord or plug is damaged.
  - b. Liquid has penetrated into the equipment.
  - c. The equipment has been exposed to moisture.
  - d. The equipment does not work well, or you cannot get it to work according to the user's manual.
  - e. The equipment has been dropped and damaged.
  - f. The equipment has obvious signs of breakage.
15. Do not place heavy objects on the equipment.
16. The unit uses a three-wire ground cable which is equipped with a third pin to ground the unit and prevent electric shock. Do not defeat the purpose of this pin. If your outlet does not support this kind of plug, contact your electrician to replace your obsolete outlet.
17. **CAUTION: DANGER OF EXPLOSION IF BATTERY IS INCORRECTLY REPLACED. REPLACE ONLY WITH THE SAME OR EQUIVALENT TYPE RECOMMENDED BY THE MANUFACTURER. DISCARD USED BATTERIES ACCORDING TO THE MANUFACTURER'S INSTRUCTIONS.**

## Technical Support and Assistance

1. For the most updated information of NEXCOM products, visit NEXCOM's website at [www.nexcom.com](http://www.nexcom.com).
2. For technical issues that require contacting our technical support team or sales representative, please have the following information ready before calling:
  - Product name and serial number
  - Detailed information of the peripheral devices
  - Detailed information of the installed software (operating system, version, application software, etc.)
  - A complete description of the problem
  - The exact wordings of the error messages

### Warning!

1. Handling the unit: carry the unit with both hands and handle it with care.
2. Maintenance: to keep the unit clean, use only approved cleaning products or clean with a dry cloth.
3. CompactFlash: Turn off the unit's power before inserting or removing a CompactFlash storage card.

## Conventions Used in this Manual



### Warning:

Information about certain situations, which if not observed, can cause personal injury. This will prevent injury to yourself when performing a task.



### Caution:

Information to avoid damaging components or losing data.



### Note:

Provides additional information to complete a task easily.



**Safety Warning:** This equipment is intended for installation in a Restricted Access Location only.



## Global Service Contact Information

### Headquarters

#### NEXCOM International Co., Ltd.

9F, No. 920, Chung-Cheng Rd.,  
ZhongHe District, New Taipei City, 23586,  
Taiwan, R.O.C.

Tel: +886-2-8226-7786

Fax: +886-2-8226-7782

www.nexcom.com

### America

#### USA

#### NEXCOM USA

2883 Bayview Drive,  
Fremont CA 94538, USA

Tel: +1-510-656-2248

Fax: +1-510-656-2158

Email: sales@nexcom.com

www.nexcom.com

### Asia

#### Taiwan

#### NEXCOM Intelligent Systems

#### Taipei Office

13F, No.920, Chung-Cheng Rd.,  
ZhongHe District,  
New Taipei City, 23586, Taiwan, R.O.C.

Tel: +886-2-8226-7796

Fax: +886-2-8226-7792

Email: sales@nexcom.com.tw

www.nexcom.com.tw

### NEXCOM Intelligent Systems

#### Taichung Office

16F, No.250, Sec. 2, Chongde Rd.,  
Beitun Dist.,

Taichung City 406, R.O.C.

Tel: +886-4-2249-1179

Fax: +886-4-2249-1172

Email: sales@nexcom.com.tw

www.nexcom.com.tw

### Japan

#### NEXCOM Japan

9F, Tamachi Hara Bldg.,  
4-11-5, Shiba Minato-ku,  
Tokyo, 108-0014, Japan

Tel: +81-3-5419-7830

Fax: +81-3-5419-7832

Email: sales@nexcom-jp.com

www.nexcom-jp.com

### China

#### NEXCOM China

1F & 2F, Block A, No. 16 Yonyou Software Park,  
No. 68 Beiqing Road, Haidian District,  
Beijing, 100094, China

Tel: +86-10-5704-2680

Fax: +86-10-5704-2681

Email: sales@nexcom.cn

www.nexcom.cn

## **NEXCOM Shanghai**

Room 603/604, Huiyinmingzun Plaza Bldg., 1,  
No.609, Yunlin East Rd.,  
Shanghai, 200333, China  
Tel: +86-21-5278-5868  
Fax: +86-21-3251-6358  
Email: sales@nexcom.cn  
www.nexcom.cn

## **NEXCOM Surveillance Technology**

Room 209, Floor 2 East, No.2,  
Science & Technology industrial park of  
privately owned enterprises,  
Xili, Nanshan Dist.,  
Shenzhen, 518055, China  
Tel: +86-755-8364-7768  
Fax: +86-755-8364-7738  
Email: steveyang@nexcom.com.tw  
www.nexcom.cn

## **NEXCOM United System Service**

Hui Yin Ming Zun Building Room 1108,  
Building No. 11, 599 Yunling Road, Putuo District,  
Shanghai, 200062, China  
Tel: +86-21-6125-8282  
Fax: +86-21-6125-8281  
Email: frankyang@nexcom.cn  
www.nexcom.cn

## **Europe**

### **United Kingdom NEXCOM EUROPE**

10 Vincent Avenue,  
Crownhill Business Centre,  
Milton Keynes, Buckinghamshire  
MK8 0AB, United Kingdom  
Tel: +44-1908-267121  
Fax: +44-1908-262042  
Email: sales.uk@nexcom.eu  
www.nexcom.eu

## **Italy**

### **NEXCOM ITALIA S.r.l**

Via Lanino 42,  
21047 Saronno (VA), Italia  
Tel: +39 02 9628 0333  
Fax: +39 02 9625 570  
Email: nexcomitalia@nexcom.eu  
www.nexcomitalia.it

## Package Contents

Before continuing, verify that the package you received is complete. Your IPPC series package should have all the items listed in the table.

### IPPC 1560T

Item	Description	Qty
1	Panel Mount Kit	8
2	Driver CD	1
3	Touch Pen	1
4	Flat Head for HDD Installation	8
5	*Terminal blocks 3-pin Phoenix Contact Plug	1



Panel Mount Kit



Driver CD



Touch Pen

### IPPC 1960T

Item	Description	Qty
1	Panel Mount Kit	8
2	Driver CD	1
3	Touch Pen	1
4	Flat Head for HDD Installation	8
5	*Terminal blocks 3-pin Phoenix Contact Plug	1



Flat Head for HDD Installation



Terminal blocks  
3-pin Phoenix  
Contact Plug

### IPPC 2160P

Item	Description	Qty
1	Driver CD	1
2	Flat Head for HDD Installation	8
3	*Terminal blocks 3-pin Phoenix Contact Plug	1

\* Terminal blocks 3-pin Phoenix Contact Plug is only for DC input model.



Note: Package contents may vary depending on your country region. Some items may be optional. Please contact your local distributor for more information.

Your APPC 1560T package should have all the items listed in the table.

**APPC 1560T**

Item	Description	Qty
1	Panel Mount Kit	12
2	Driver CD	1
3	Touch Pen	1
4	Flat Head for HDD Installation	4
5	*Terminal blocks 3-pin Phoenix Contact Plug	1
6	Panel Mount Hole Block	12

\* Terminal blocks 3-pin Phoenix Contact Plug is only for DC input model.



Note: Package contents may vary depending on your country region. Some items may be optional. Please contact your local distributor for more information.



Panel Mount Kit



Driver CD



Touch Pen



Terminal blocks  
3-pin Phoenix  
Contact Plug



Flat Head Screw



Panel Mount Hole Block

## Ordering Information

The following provides ordering information for the Industrial Panel PC series.

### IPPC 1560T Series

- **IPPC 1560TP2E-DC (P/N: 10II1560T00X0)**  
15" XGA LED backlight fanless touch panel PC, Intel® Core™ i5-3610ME 2.7GHz, touch screen, 4GB DDR3, 3 x COMs, DC power input
- **IPPC 1560TP2E-AC (P/N: 10II1560T01X0)**  
15" XGA LED backlight fanless touch panel PC, Intel® Core™ i5-3610ME 2.7GHz, touch screen, 4GB DDR3, 6 x COMs, 4 x 4GPIO, 4 x 4DIO with isolated protection, AC power input
- **IPPC 1560TE (P/N: 10II1560T02X0)**  
15" XGA LED backlight fanless touch panel PC, Intel® Core™ i5-3610ME 2.7GHz, touch screen, 4GB DDR3, 3 x COMs, isolated protection DC Power

### Optional

- **24V/5A, 120W AC to DC DIN rail power adapter w/ o power cord (P/N: 7440120001X00) (for IPPC 1560TP2EDC and IPPC 1560TE)**
- **Riser card 2 x PCI slots (P/N: 20JK036P200X0)**
- **Riser card 2 x PCIe x4 slots (P/N: 20JK036E200X2)**
- **Fieldbus module universal kit (for IPPC 1560TP2E-DC and IPPC 1560TE)**

88J50090E00X0	FBI 90E-PNM kit (w/ 25 cm cable)	PROFINET master
88J50090E01X0	FBI 90E-EP kit (w/ 25 cm cable)	EtherNet/IP master
88J50090E02X0	FBI 90E-ECM kit (w/ 25 cm cable)	EtherCAT master
88J50090E03X0	FBI 90E-PBM kit (w/ 25 cm cable)	PROFIBUS master
88J50090E04X0	FBI 90E-DNM kit (w/ 25 cm cable)	DeviceNET master

### IPPC 1960T Series

- **IPPC 1960TP2E-DC (P/N: 10II1960T00X0)**  
19" SXGA LED backlight fanless touch panel PC, Intel® Core™ i5-3610ME 2.7GHz, touch screen, 4GB DDR3, 3 x COMs, DC power input
- **IPPC 1960TP2E-AC (P/N: 10II1960T01X0)**  
19" SXGA LED backlight fanless touch panel PC, Intel® Core™ i5-3610ME 2.7GHz, touch screen, 4GB DDR3, 6 x COMs, 4 x 4GPIO, 4 x 4DIO with isolated protection, AC power input

### Optional

- **24V/5A, 120W AC to DC DIN rail power adapter w/ o power cord (P/N: 7440120001X00) (for IPPC 1960TP2EDC only)**
- **Riser card 2 x PCI slots (P/N: 20JK036P200X0)**
- **Riser card 2 x PCIe x4 slots (P/N: 20JK036E200X2)**
- **Fieldbus module universal kit (for IPPC 1960TP2E-DC only)**

88J50090E00X0	FBI 90E-PNM kit (w/ 25 cm cable)	PROFINET master
88J50090E01X0	FBI 90E-EP kit (w/ 25 cm cable)	EtherNet/IP master
88J50090E02X0	FBI 90E-ECM kit (w/ 25 cm cable)	EtherCAT master
88J50090E03X0	FBI 90E-PBM kit (w/ 25 cm cable)	PROFIBUS master
88J50090E04X0	FBI 90E-DNM kit (w/ 25 cm cable)	DeviceNET master

## IPPC 2160P

- **IPPC 2160PP2E-AC (P/N: 10I12160P00X0)**

21.5" Full HD LED backlight fanless touch panel PC, Intel® Core™ i5-3610ME 2.7GHz, ten points P-Cap touch screen, 4GB DDR3, 6 x COMs, 4 x 4 GPIO, 4 x 4 D/I/O with isolated protection, AC power input

### Optional

- **Riser card 2 x PCI slots (P/N: 20JK036P200X0)**
- **Riser card 2 x PCIe x4 slots (P/N: 20JK036E200X2)**

## APPC 1560T

- **APPC 1560T-ET (P/N: 10IA1560T00X2)**

15" XGA LED backlight fanless touch panel PC, Intel® Celeron® B810 1.6GHz, touch screen, 4GB DDR3, 3 x COMs, AC power input

### Optional

- **24V/5A, 120W AC to DC DIN rail power adapter w/o power cord (P/N: 7440120001X00) (for APPC 1560T-DC)**

# Chapter 1: Product Introduction

## IPPC 1560T Series



IPPC 1560TP2E-DC



IPPC 1560TP2E-AC



IPPC 1560TE

### Key Features

- 4:3 15" XGA Fanless Panel Computer
- Powerful 2nd/3rd generation Intel® Core™ processor
- Two expansion slots for add-on PCI or/and PCIe cards
- Optional 3.5G/Wi-Fi module/2.5" HDD/3 x Coms/GPIO/DIO/Dimming Control Button
- Front accessible USB 2.0 for easy of field maintenance (hidden on IPPC 1560TE)
- Metal housing with robust aluminum front bezel for harsh environment
- IP65 compliant front panel
- Support fieldbus module, JMobile HMI, Citect SCADA and CODESYS (optional)
- Optional: wide range DC power input model/isolation protection DC power input model
- For Class I, Division 2 Hazardous Locations (IPPC 1560TE)

## Specifications

### System

- CPU: Support 2nd/3rd gen. Intel® Core™ processor family, rPGA 988
  - Intel® Core™ i7-3520ME (2 x 2.9GHz, 4M cache, Max. TDP 35W)
  - Intel® Core™ i5-3610ME (2 x 2.7GHz, 3M cache, Max. TDP 35W) (Default)
  - Intel® Core™ i3-3120ME (2 x 2.4GHz, 3M cache, Max. TDP 35W)
  - Intel® Celeron® B810 (2 x 1.6GHz, 2M cache, Max. TDP 35W)
  - Intel® Pentium® B950 (2 x 2.1GHz, 2M cache, Max. TDP 35W)
- BIOS: AMI BIOS
- System chipset: Intel® HM76 Express chipset
- System memory: 1x 204-pin DDR3 SO-DIMM socket, 4G DDR3 (default), support up to 8GB DDR3-1066/1333, non-ECC and un-buffered
- Storage Device:
  - 1x external locked CFast socket
  - 2x hard drive bay: optional 2x 2.5" SATA HDD
- Watchdog timer: Watchdog timeout can be programmed by software from 1 second to 255 seconds and from 1 minute to 255 minutes (Tolerance 15% under room temperature 25°C)
- HW status monitor: Monitoring system temperature, and voltage
- Expansion:
  - 2x Mini-PCIe sockets (support optional Wi-Fi or 3.5G module)
  - 2x expansion slots for add-on PCI or/and PCIe cards
  - 1x PCI and 1x PCIe x4 slots (default)
  - 2x PCIe x4 slots
  - 2x PCI slots
- Panel backlight control button: increase brightness/decrease brightness/backlight on/off (for IPPC 1560TP2E-AC only)

### Rear I/O

For All

- 2x PS2 keyboard/mouse (not supported on IPPC 1560TE)
- 2nd display VGA port: 1x DB15
- Ethernet: 2x RJ45

For IPPC 1560TP2E-DC only

- USB: 5x USB 2.0 (1 in front)
- Audio port: 1x Line-out; 1x Line-in; 1x MIC-in
- COM #1: RS232/422/485 w/ RI or 5V or 12V selection
- COM #2: RS232/422/485 w/ RI or 5V or 12V selection
- COM #3: RS232 w/ RI or 5V or 12V selection
- ATX power switch
- Reset button

For IPPC 1560TP2E-AC only

- USB: 5x USB 2.0 (1 in front)
- Audio port: 1x Line-out; 1x Line-in; 1x MIC-in
- COM #1: RS232/422/485 w/ 2.5kv isolated protection
- COM #2: RS232/422/485 w/ 2.5kv isolated protection
- COM #3: RS232 w/ RI or 5V or 12V selection
- COM #4: RS232 w/ RI or 5V or 12V selection
- COM #5: RS232
- COM #6: RS232
- DIO w/ 2.5kv isolated protection:
  - 4x digital input (source type)
    - Input voltage (dry contact): Logic 0: Close to GND
    - Logic 1: open
    - Input voltage: Logic 0: 3V max.
    - Logic 1: +5 to 30V
  - 4x digital output (sink type)
    - Output voltage: +3.6 to 5V
    - Sink current: 200mA max. per channel



- GPIO: 4x digital in/4x digital out
- LPT: Parallel port
- AC Power switch
- Reset button

For IPPC 1560TE only

- USB: 4x USB2.0 (Hidden)
- COM #1: RS232/422/485 w/ 2.5kv isolated protection
- COM #2: RS232/422/485 w/ 2.5kv isolated protection
- COM #3: RS232 w/ RI or 5V or 12V selection
- ATX Power switch
- Reset button

### Audio

- AC97 codec: Realtek ALC886-GR
- Audio interface: Line-out/Line-in/MIC-in audio Jack

### Ethernet

- LAN chip: dual Intel® 82574L Gigabit LAN
- Ethernet interface: 10/100/1000 Based-Tx Ethernet compatible

### Fieldbus

- IPPC 1560TP2E-DC/IPPC 1560TE: support up to two fieldbus module (1 universal kit and 1 special kit)
- IPPC 1560TP2E-AC: support one special fieldbus module kit

### Mechanical & Environment

- Color: pantone 432C\RAL 70 24 front bezel
- Enclosure: aluminum front bezel with SPPC nickel plated housing
- IP protection: IP65 front
- Mounting: panel/wall/stand/VESA 100mm x 100mm
- Power

For IPPC 1560TP2E-DC

- Power input: 12-30 V dc, 7-2.5 A, Class 2
- Power adapter: optional AC to DC DIN rail power adapter (+24V, 120W)

For IPPC 1560TP2E-AC

- Power input: 100-240V~, 1.5A, 50-60Hz; fuse: 250VAC/3A

- Power connector: AC inlet (IEC60320 C14)
- Power supply: 120W

For IPPC 1560TE

- Power input: 24 V dc, 4A, Class 2
- Power protection: +-20% with 1.5kv isolated protection
- Fuse: 250V/10A
- Vibration:
  - IEC 68 2-64 (w/ HDD)
  - 1Grms @ sine, 5~500Hz, 1hr/axis (HDD operating)
  - 2Grms @ sine, 5~500Hz, 1hr/axis (CFast operating)
  - 2.2Grms @ random condition, 5~500Hz, 0.5hr/axis (non-operating)
- Shock:
  - IEC 68 2-27
  - HDD: 20G @ wall mount, half sine, 11ms
- Operating temperature: -10°C to 50°C
  - \* Intel® Core™ i7/Intel® Celeron® B810/Intel® Pentium® B950: -10°C to 40°C
- Storage temperature: -20°C to 75°C
- Operating humidity: 10%~90% relative humidity, non-condensing
  - Limits to be at 90% RH at max 50°C
- Dimension: 477.64 x 310 x 95.72mm
- Weight: -AC: 9.75Kg
  - DC: 9.34Kg
  - TE: 9.51Kg

### Certifications

- CE (including EN61000-6-2/EN61000-6-4)
- FCC Class A
- -AC: LVD 60950-1
- -DC/TE: UL508



IPPC 1560TE is certified for explosion protection. For more information on the relevant safety standards and installation instructions, please refer to the dedicated IPPC 1560TE user manual.

## IPPC 1960T Series



IPPC 1960TP2E-DC



IPPC 1960TP2E-AC

### Key Features

- 4:3 19" SXGA Fanless Panel Computer
- Powerful 2nd/3rd generation Intel® Core™ processor
- Two expansion slots for add-on PCI or/and PCIe cards
- Optional 3.5G/Wi-Fi module/2.5" HDD/3x Coms/GPIO/DIO/Dimming Control Button
- Front accessible USB 2.0 for easy of field maintenance
- Metal housing with robust aluminum front bezel for harsh environment
- IP66 compliant front panel
- Support fieldbus module, JMobile HMI, Citect SCADA and CODESYS (optional)
- Wide range DC power input model

## Specifications

### System

- CPU: Support 2nd/3rd gen. Intel® Core™ processor family, rPGA 988
  - Intel® Core™ i7-3520ME (2 x 2.9GHz, 4M cache, Max. TDP 35W)
  - Intel® Core™ i5-3610ME (2 x 2.7GHz, 3M cache, Max. TDP 35W) (Default)
  - Intel® Core™ i3-3120ME (2 x 2.4GHz, 3M cache, Max. TDP 35W)
  - Intel® Celeron® B810 (2 x 1.6GHz, 2M cache, Max. TDP 35W)
  - Intel® Pentium® B950 (2 x 2.1GHz, 2M cache, Max. TDP 35W)
- BIOS: AMI BIOS
- System chipset: Intel® HM76 Express chipset
- System memory: 1x 204-pin DDR3 SO-DIMM socket, 4G DDR3 (default), support up to 8GB DDR3-1066/1333, non-ECC and un-buffered
- Storage Device:
  - 1x external locked CFast socket
  - 2x hard drive bay: optional 2x 2.5" SATA HDD
- Watchdog timer: Watchdog timeout can be programmed by software from 1 second to 255 seconds and from 1 minute to 255 minutes (Tolerance 15% under room temperature 25°C)
- HW status monitor: Monitoring system temperature, and voltage
- Expansion:
  - 2x Mini-PCIe sockets (support optional Wi-Fi or 3.5G module)
  - 2x expansion slots for add-on PCI or/and PCIe cards
  - 1x PCI and 1x PCIe x4 slots (default)
  - 2x PCIe x4 slots
  - 2x PCI slots
- Panel backlight control button: increase brightness/decrease brightness/backlight on/off (for IPPC 1960TP2E-AC only)

### Rear I/O

For All

- 2x PS2 keyboard/mouse
- 2nd display VGA port: 1x DB15
- Ethernet: 2x RJ45
- USB: 5x USB 2.0 (1 in front)
- Audio port: 1x Line-out; 1x Line-in; 1x MIC-in

For IPPC 1960TP2E-DC only

- COM #1: RS232/422/485 w/ RI or 5V or 12V selection
- COM #2: RS232/422/485 w/ RI or 5V or 12V selection
- COM #3: RS232 w/ RI or 5V or 12V selection
- ATX power switch
- Reset button

For IPPC 1960TP2E-AC only

- COM #1: RS232/422/485 w/ 2.5kv isolated protection
- COM #2: RS232/422/485 w/ 2.5kv isolated protection
- COM #3: RS232 w/ RI or 5V or 12V selection
- COM #4: RS232 w/ RI or 5V or 12V selection
- COM #5: RS232
- COM #6: RS232
- DIO w/ 2.5kv isolated protection:
  - 4x digital input (source type)
    - Input voltage (dry contact): Logic 0: Close to GND
    - Logic 1: open
    - Input voltage: Logic 0: 3V max.
  - Logic 1: +5 to 30V
  - 4x digital output (sink type)
    - Output voltage: +3.6 to 5V
    - Sink current: 200mA max. per channel

- GPIO: 4x digital in/4x digital out
- LPT: Parallel port
- AC Power switch
- Reset button

### Audio

- AC97 codec: Realtek ALC886-GR
- Audio interface: Line-out/Line-in/MIC-in audio Jack

### Ethernet

- LAN chip: dual Intel® 82574L Gigabit LAN
- Ethernet interface: 10/100/1000 Based-Tx Ethernet compatible

### Fieldbus

- IPPC 1960TP2E-DC: support up to two Fieldbus Module (1 universal kit and 1 special kit)
- IPPC 1960TP2E-AC: support one special Fieldbus Module kit

### Mechanical & Environment

- Color: pantone 432C\ RAL 70 24 front bezel
- Enclosure: aluminum front bezel with SPPC nickel plated housing
- IP protection: IP66 front
- Mounting: panel/wall/stand/VESA 100mm x 100mm
- Power

For IPPC 1960TP2E-DC

- Power input: 12-30 V dc, 7-2.5 A, Class 2
- Power adapter: optional AC to DC DIN rail power adapter (+24V, 120W)

For IPPC 1960TP2E-AC

- Power input: 100-240V~, 1.5A, 50-60Hz; Fuse: 250VAC/3A
- Power connector: AC inlet (IEC60320 C14)
- Power supply: 120W

- Vibration:
  - IEC 68 2-64 (w/ HDD)
  - 1Grms @ sine, 5~500Hz, 1hr/axis (HDD operating)
  - 2Grms @ sine, 5~500Hz, 1hr/axis (CFast operating)
  - 2.2Grms @ random condition, 5~500Hz, 0.5hr/axis (non-operating)
- Shock:
  - IEC 68 2-27
  - HDD: 20G @ wall mount, half sine, 11ms
- Operating temperature: -10°C to 50°C
  - \* Intel® Core™ i7/Intel® Celeron® B810/Intel® Pentium® B950: -10°C to 40°C
- Storage temperature: -20°C to 75°C
- Operating humidity: 10%~90% relative humidity, non-condensing  
Limits to be at 90% RH at max 50°C
- Dimension: 477.64 x 399.24 x 99.38mm  
Weight: -AC: 11.2Kg  
-DC: 10.6Kg

### Certifications

- CE (including EN61000-6-2/EN61000-6-4)
- FCC Class A
- -AC: LVD 60950-1

## IPPC 2160P



### Key Features

- 16:9 21.5" Full HD fanless LED panel computer
- Powerful 2nd/3rd generation Intel® Core™ processor
- Two expansion slots for add-on PCI or/and PCIe cards
- Optional 3.5G/Wi-Fi module/2.5" HDD/3x Coms/GPIO/DIO/Dimming control button
- 10 points P-Cap multi-touch with zero bezel flush front design
- Metal housing with robust aluminum front bezel for harsh environment
- IP66 compliant front panel
- Anti-scratch surface: 7H hardness
- Support fieldbus module, JMobile HMI, Citect SCADA and CODESYS (optional)
- Optional: AC power input model/DC power input model

## Specifications

### Panel

- LED size: 21.5", 16:9
- Resolution: Full HD 1920 x 1080
- Luminance: 300cd/m<sup>2</sup>
- Contrast ratio: 5000
- LCD color: 16.7M
- Viewing angle: 89(U), 89(D), 89(L), 89(R)
- Backlight: LED

### Touch Screen

- Ten points P-Cap (Projected Capacitive Touch)
- Touch light transmission: 87%
- Anti-scratch surface: 7H hardness
- Touch interface: USB
- Windows 8 compliance

### System

- CPU: Support 2nd/3rd gen. Intel® Core™ processor family, rPGA 988
  - Intel® Core™ i7-3520ME (2 x 2.9GHz, 4M cache, Max. TDP 35W)
  - Intel® Core™ i5-3610ME (2 x 2.7GHz, 3M cache, Max. TDP 35W) (Default)
  - Intel® Celeron® 1020E (2.2GHz, 2M cache, Max. TDP 35W)
- BIOS: AMI BIOS
- System chipset: Intel® HM76 Express chipset
- System memory: 1x 204-pin DDR3 SO-DIMM socket, 4G DDR3 (default), support up to 8GB DDR3-1066/1333, non-ECC and un-buffered
- Storage Device:
  - 1x external locked CFast socket
  - 2x hard drive bay: optional 2x 2.5" SATA HDD
- Watchdog timer: Watchdog timeout can be programmed by software

- from 1 second to 255 seconds and from 1 minute to 255 minutes (Tolerance 15% under room temperature 25°C)
- H/W status monitor: Monitoring system temperature, and voltage
- Expansion:
  - 2x Mini-PCIe sockets (support optional Wi-Fi or 3.5G module)
  - 2x expansion slots for add-on PCI or/and PCIe cards
  - 1x PCI and 1x PCIe x4 slots (default)
  - 2x PCIe x4 slots
  - 2x PCI slots
- Panel backlight control button: increase brightness/decrease brightness/backlight on/off (for IPPC 2160PP2E-AC only)

### Rear I/O

For All

- 2x PS2 keyboard/mouse
- 2nd display VGA port: 1x DB15
- Ethernet: 2x RJ45
- USB: 4x USB 2.0
- Audio port: 1x Line-out; 1x Line-in; 1x MIC-in

For IPPC 2160PP2E-DC only

- COM #1: RS232/422/485 w/ RI or 5V or 12V selection
- COM #2: RS232/422/485 w/ RI or 5V or 12V selection
- COM #3: RS232 w/ RI or 5V or 12V selection
- ATX power switch
- Reset button

For IPPC 2160PP2E-AC only

- COM #1: RS232/422/485 w/ 2.5kv isolated protection
- COM #2: RS232/422/485 w/ 2.5kv isolated protection
- COM #3: RS232 w/ RI or 5V or 12V selection
- COM #4: RS232 w/ RI or 5V or 12V selection

- COM #5: RS232
- COM #6: RS232
- DIO w/ 2.5kv isolated protection:
  - 4x digital input (source type)
    - Input voltage (dry contact): Logic 0: Close to GND
    - Logic 1: open
    - Input voltage: Logic 0: 3V max.
    - Logic 1: +5 to 30V
  - 4x digital output (sink type)
    - Output voltage: +3.6 to 5V
    - Sink current: 200mA max. per channel
- GPIO: 4x Digital In/4x Digital Out
- LPT: parallel port
- AC power switch
- Reset button

### Audio

- AC97 codec: Realtek ALC886-GR
- Audio interface: Line-out/Line-in/MIC-in audio Jack

### Ethernet

- LAN chip: dual Intel® 82574L Gigabit LAN
- Ethernet interface: 10/100/1000 Based-Tx Ethernet compatible

### Fieldbus

- IPPC 2160PP2E-DC: support up to two Fieldbus Module (1 universal kit and 1 special kit)
- IPPC 2160PP2E-AC: support one special Fieldbus Module kit

### Mechanical & Environment

- Color: pantone 432C\ RAL 70 24 front bezel
- Enclosure: aluminum front bezel with SPPC nickel plated housing
- IP protection: IP66 front

- Mounting: panel/wall/stand/VESA 100mm x 100mm
- Power

#### For IPPC 2160PP2E-DC

- Power input: 12-30 V dc, 7-2.5 A, Class 2
- Power adapter: optional AC to DC DIN rail power adapter (+24V, 120W)

#### For IPPC 2160PP2E-AC

- Power input: 100-240V~, 1.5A, 50-60Hz; Fuse: 250VAC/3A
- Power connector: AC inlet (IEC60320 C14)
- Power supply: 120W

- Vibration:
  - IEC 68 2-64 (w/ HDD)
  - 1Grms @ sine, 5~500Hz, 1hr/axis (HDD operating)
  - 2Grms @ sine, 5~500Hz, 1hr/axis (CFast operating)
  - 2.2Grms @ random condition, 5~500Hz, 0.5hr/axis (non-operating)
- Shock:
  - IEC 68 2-27
  - HDD: 20G @ wall mount, half sine, 11ms
- Operating temperature: -10°C to 50°C
  - \* Intel® Core™ i7/Intel® Celeron® B810/Intel® Pentium® B950: -10°C to 40°C
- Storage temperature: -20°C to 75°C
- Operating humidity: 10%~90% relative humidity, non-condensing
- Dimension: 562.4mm x 382.4mm x 92.27mm
- Weight: 11.9Kg for IPPC 2160PP2E-DC  
12.51Kg for IPPC 2160PP2E-AC

### Certifications

- CE (including EN61000-6-2/EN61000-6-4)
- FCC Class A
- AC: LVD 60950-1

## APPC 1560T



### Key Features

- 4:3 15" XGA fanless LED panel computer
- Powerful 2nd/ 3rd generation Intel® Core™ processor
- DDR3 4GB
- Flush Panel by 5-wire Touch Screen
- Optional 3.5G/ Wi-Fi module/ 2.5" HDD
- IP65 compliant front panel
- Support fieldbus module, JMobile HMI, Citect SCADA and CODESYS (optional)
- Optional: AC power input model/ DC power input model



## Specifications

### Panel

- LED Size: 15" 4:3
- Resolution: XGA 1024x768
- Luminance: 400cd/m<sup>2</sup>
- Contract Ratio: 700
- LCD Color: 16.2M
- Viewing Angle: 60(U), 80(D), 80(L), 80(R)
- Backlight: LED

### Touch Screen

- 5-wire resistive (flush panel type)
- Light transmission: 80%
- Interface: USB

### System

- CPU: Support 2nd/3rd gen. Intel® Core™ processor family, rPGA 988
  - Intel® Core™ i7-3520ME (2 x 2.9GHz, 4M cache, Max. TDP 35W)
  - Intel® Core™ i5-3610ME (2 x 2.7GHz, 3M cache, Max. TDP 35W)
  - Intel® Core™ i3-3120ME (2 x 2.4GHz, 3M cache, Max. TDP 35W)
  - Intel® Celeron® B810 (2 x 1.6GHz, 2M cache, Max. TDP 35W) (Default)
  - Intel® Pentium® B950 (2 x 2.1GHz, 2M cache, Max. TDP 35W)
- BIOS: AMI BIOS
- System chipset: Intel® HM76 Express chipset
- System memory: 1x 204-pin DDR3 SO-DIMM socket, 4G DDR3 (default), support up to 8GB DDR3-1066/1333, non-ECC and un-buffered
- Storage Device:
  - 1x external locked CFast socket
  - 1x hard drive bay
  - 1x SATA DOM (Optional)

- Watchdog timer: Watchdog timeout can be programmed by software from 1 second to 255 seconds and from 1 minute to 255 minutes (Tolerance 15% under room temperature 25°C)
- H/W status monitor: Monitoring system temperature, and voltage
- Expansion:
  - 2x Mini-PCIe sockets (support optional Wi-Fi or 3.5G module)

### Rear I/O

For All

- 2x PS2 keyboard/mouse
- 2nd display VGA port: 1x DB15
- Ethernet: 2x RJ45
- USB: 4x USB 2.0
- Audio port: 1x Line-out; 1x Line-in; 1x MIC-in
- COM #3: RS232 w/ RI or 5V or 12V selection
- Reset button

For APPC 1560T-DC

- COM #1: RS232/422/485 w/ RI or 5V or 12V selection
- COM #2: RS232/422/485 w/ RI or 5V or 12V selection
- ATX Power switch

For APPC 1560T-AC (Default)

- COM #1: RS232/422/485 w/ 2.5kv isolated protection
- COM #2: RS232/422/485 w/ 2.5kv isolated protection
- AC Power switch

### Audio

- AC97 codec: Realtek ALC886-GR
- Audio interface: Line-out/Line-in/MIC-in Audio Jack

## Ethernet

- LAN chip: dual Intel® 82574L Gigabit LAN
- Ethernet interface: 10/100/1000 Based-Tx Ethernet compatible

## Fieldbus

- Support one special fieldbus module kit

## Mechanical & Environment

- Color: pantone black\ RAL 15 00 front bezel
- Enclosure: Plastic front bezel
- IP protection: IP65 front
- Mounting: panel mounting
- Power

For APPC 1560T-DC

- Power input: 12-30 V dc, 7-2.5 A, Class 2
- Power adapter: Optional AC to DC DIN Rail Power Adapter (+24V, 120W)

For APPC 1560T-AC

- Power input: 100-240V~, 1.5A, 50-60Hz; Fuse: 250VAC/3A
- Power connector: AC Inlet (IEC60320 C14)
- Power supply: 120W
- Vibration:
  - IEC 68 2-64 (w/ HDD)
  - 1Grms @ sine, 5~500Hz, 1hr/axis (HDD operating)
  - 2Grms @ sine, 5~500Hz, 1hr/axis (CFast operating)
  - 2.2Grms @ random condition, 5~500Hz, 0.5hr/axis (non-operating)
- Shock:
  - IEC 68 2-27
  - HDD: 20G @ wall mount, half sine, 11ms
- Operating temperature: -10°C to 50°C
  - \* Intel® Core™ i7 / Intel® Celeron® B810 / Intel® Pentium® B950: -10°C to 40°C
- Storage temperature: -20°C to 75°C
- Operating humidity: 10%~90% relative humidity, non-condensing

- Limits to be at 90% RH at max 50°C
- Dimension: 384.37 x 309.95 x 92.62 mm
- Weight: -AC: 7.7Kg  
-DC: 7.1Kg

## Certifications

- CE
- FCC Class A
- AC: LVD 60950-1

## Knowing Your IPPC 1560T Series

### IPPC 1560TP2E-DC Rear Top

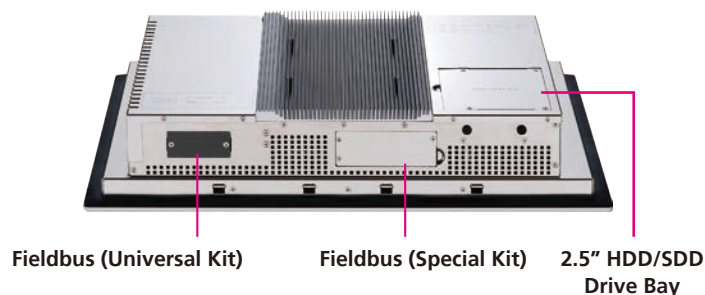

#### Fieldbus (Universal Kit and Special Kit)

Expansion slots for add-on fieldbus modules.

#### 2.5" HDD/SDD Drive Bay

Used to install a 2.5" HDD/SSD.

#### Power Switch

Press to power-on or power-off the system.

#### Reset Switch

Press this button to restart the system.

#### DC Input

Used to plug a DC power cord (terminal block connector).



Please use 12-28 AWG wire size and tighten the terminal block with a torque value of 4.5 lb-in.

#### PS/2 KB/MS

Used to connect a PS/2 keyboard and a PS/2 mouse.

#### COM 1 to COM 3

COM 1 and COM 2 ports have 2.5kV isolated protection and support RS232/422/485 compatible serial devices. COM 3 supports RS232 and 5V, 12V or RI by selection.

#### VGA

Used to connect an analog VGA monitor.

#### LAN

Used to connect the system to a local area network. LAN1 supports Wake up on LAN.

#### USB

Used to connect USB 2.0/1.1 devices.

#### Audio Connectors

Line-in, mic-in and line-out ports used to connect audio devices such as external microphones, speakers and headphones.

### IPPC 1560TP2E-DC Rear Bottom

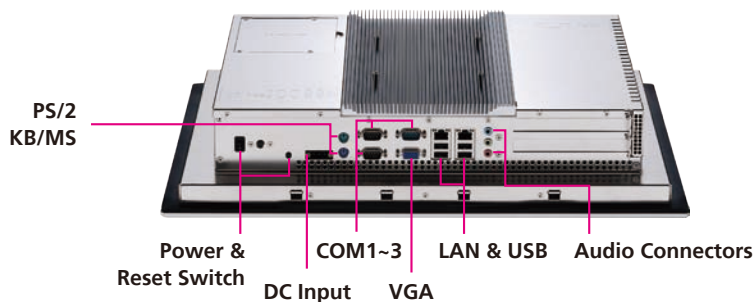

## IPPC 1560TP2E-AC Rear Top

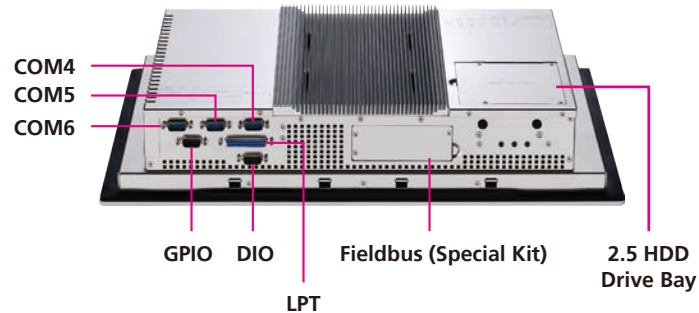

### COM 4 to COM 6

These COM ports support RS232 compatible serial devices. COM 4 supports 5V, 12V or RI by selection.

### GPIO

The GPIO connector supports 4 digital input and 4 digital output.

### DIO

The GPIO connector supports 4 digital input and 4 digital output with 2.5kV isolated protection.

### LPT

Parallel port used to connect LPT devices.

### Fieldbus (Special Kit)

Expansion slot for add-on fieldbus modules.

### 2.5" HDD/SDD Drive Bay

Used to install a 2.5" HDD/SSD.

### Power Switch

Press to power-on or power-off the system.

### Reset Switch

Press this button to restart the system.

### AC Input

Used to plug an AC power cord.

### PS/2 KB/MS

Used to connect a PS/2 keyboard and a PS/2 mouse.

## IPPC 1560TP2E-AC Rear Bottom

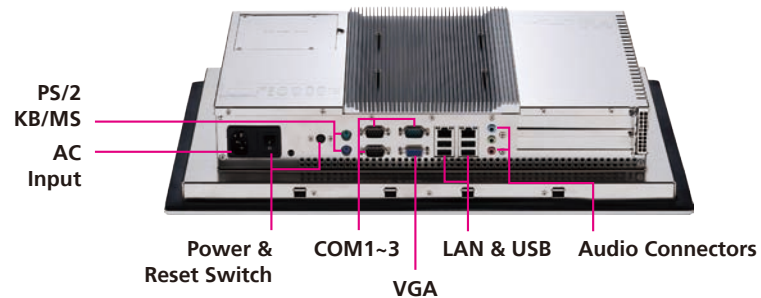

### **COM 1 to COM 3**

COM 1 and COM 2 ports have 2.5kV isolated protection and support RS232/422/485 compatible serial devices.  
COM 3 supports RS232 and 5V, 12V or RI by selection.

### **VGA**

Used to connect an analog VGA monitor.

### **LAN**

Used to connect the system to a local area network. LAN1 supports Wake up on LAN.

### **USB**

Used to connect USB 2.0/1.1 devices.

### **Audio Connectors**

Line-in, mic-in and line-out ports used to connect audio devices such as external microphones, speakers and headphones.

## IPPC 1560TE Rear Top

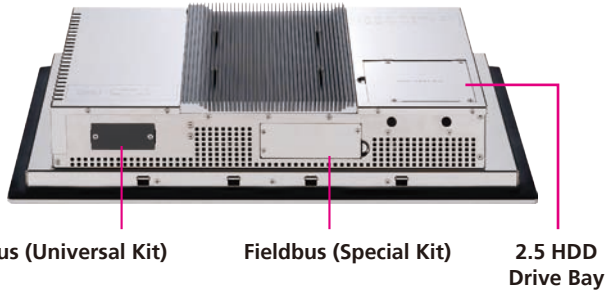

### Fieldbus (Universal Kit and Special Kit)

Expansion slots for add-on fieldbus modules.

### 2.5" HDD/SDD Drive Bay

Used to install a 2.5" HDD/SSD.

### Power Switch

Press to power-on or power-off the system.

### Reset Switch

Press this button to restart the system.

### DC Input

Used to plug a DC power cord.



Please use 12-28 AWG wire size and tighten the terminal block with a torque value of 4.5 lb-in.

## IPPC 1560TE Rear Bottom

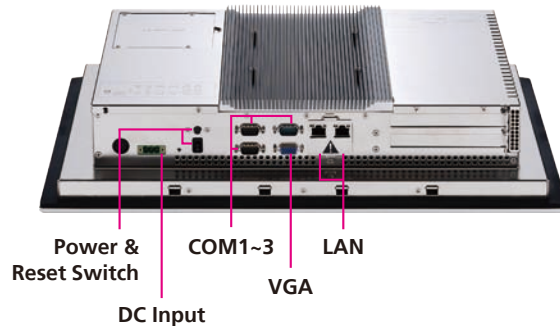

### COM 1 to COM 3

COM 1 and COM 2 ports have 2.5kV isolated protection and support RS232/422/485 compatible serial devices. COM 3 supports RS232 and 5V, 12V or RI by selection.

### VGA

Used to connect an analog VGA monitor.

### LAN

Used to connect the system to a local area network. LAN1 supports Wake up on LAN.

## Knowing Your IPPC 1960T Series

### IPPC 1960TP2E-DC Rear Top



Fieldbus (Universal Kit)      Fieldbus (Special Kit)      2.5" HDD/SDD Drive Bay

### IPPC 1960TP2E-DC Rear Bottom

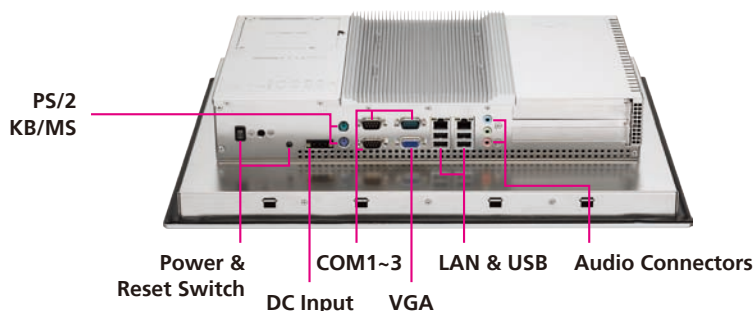

PS/2 KB/MS  
Power & Reset Switch      DC Input      COM1~3      VGA      LAN & USB      Audio Connectors

#### Fieldbus (Universal Kit and Special Kit)

Expansion slots for add-on fieldbus modules.

#### 2.5" HDD/SDD Drive Bay

Used to install a 2.5" HDD/SSD.

#### Power Switch

Press to power-on or power-off the system.

#### Reset Switch

Press this button to restart the system.

#### DC Input

Used to plug a DC power cord (terminal block connector).



Please use 12-28 AWG wire size and tighten the terminal block with a torque value of 4.5 lb-in.

#### PS/2 KB/MS

Used to connect a PS/2 keyboard and a PS/2 mouse

#### COM 1 to COM 3

COM 1 and COM 2 ports have 2.5kV isolated protection and support RS232/422/485 compatible serial devices.  
COM 3 supports RS232 and 5V, 12V or RI by selection.

#### VGA

Used to connect an analog VGA monitor.

#### LAN

Used to connect the system to a local area network. LAN1 supports Wake up on LAN.

#### USB

Used to connect USB 2.0/1.1 devices.

#### Audio Connectors

Line-in, mic-in and line-out ports used to connect audio devices such as external microphones, speakers and headphones.

## IPPC 1960TP2E-AC Rear Top

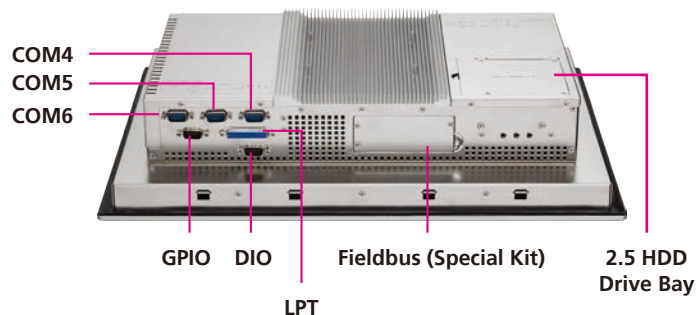

### COM 4 to COM 6

These COM ports support RS232 compatible serial devices. COM 4 supports 5V, 12V or RI by selection.

### GPIO

The GPIO connector supports 4 digital input and 4 digital output.

### DIO

The GPIO connector supports 4 digital input and 4 digital output with 2.5kV isolated protection.

### LPT

Parallel port used to connect LPT devices.

### Fieldbus (Special Kit)

Expansion slot for add-on fieldbus modules.

### 2.5" HDD/SDD Drive Bay

Used to install a 2.5" HDD/SSD.

## IPPC 1960TP2E-AC Rear Bottom

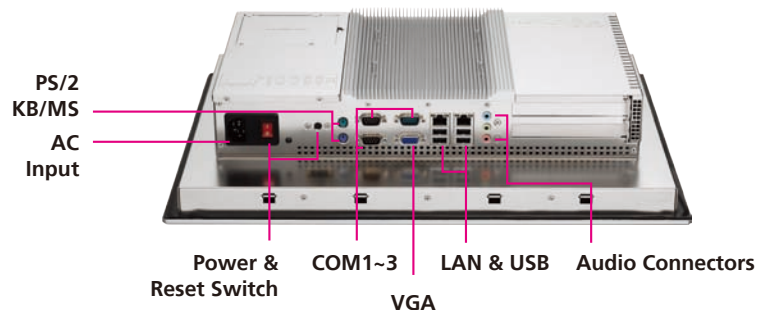

### Power Switch

Press to power-on or power-off the system.

### Reset Switch

Press this button to restart the system.

### AC Input

Used to plug an AC power cord.

### PS/2 KB/MS

Used to connect a PS/2 keyboard and a PS/2 mouse.



### **COM 1 to COM 3**

COM 1 and COM 2 ports have 2.5kV isolated protection and support RS232/422/485 compatible serial devices.  
COM 3 supports RS232 and 5V, 12V or RI by selection.

### **VGA**

Used to connect an analog VGA monitor.

### **LAN**

Used to connect the system to a local area network. LAN1 supports Wake up on LAN.

### **USB**

Used to connect USB 2.0/1.1 devices.

### **Audio Connectors**

Line-in, mic-in and line-out ports used to connect audio devices such as external microphones, speakers and headphones.

## Knowing Your IPPC 2160P

### IPPC 2160P Rear Top

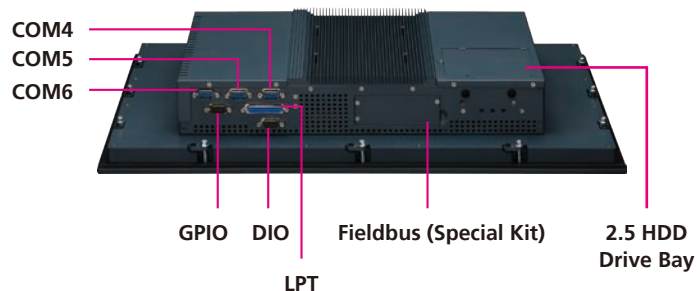

### IPPC 2160P Rear Bottom

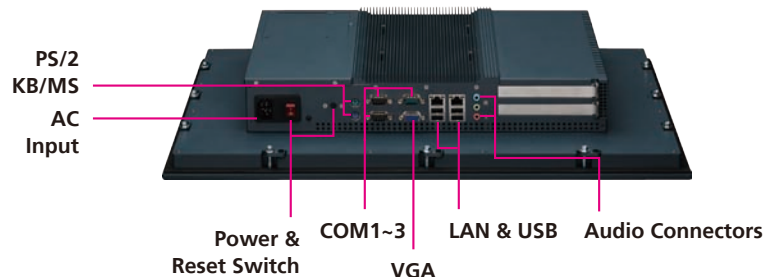

#### COM 4 to COM 6

These COM ports support RS232 compatible serial devices. COM 4 supports 5V, 12V or RI by selection.

#### GPIO

The GPIO connector supports 4 digital input and 4 digital output.

#### DIO

The GPIO connector supports 4 digital input and 4 digital output with 2.5kV isolated protection.

#### LPT

Parallel port used to connect LPT devices.

#### Fieldbus (Special Kit)

Expansion slot for add-on fieldbus modules.

#### 2.5" HDD/SDD Drive Bay

Used to install a 2.5" HDD/SSD.

#### Power Switch

Press to power-on or power-off the system.

#### Reset Switch

Press this button to restart the system.

#### AC Input

Used to plug an AC power cord.

#### PS/2 KB/MS

Used to connect a PS/2 keyboard and a PS/2 mouse.

### **COM 1 to COM 3**

COM 1 and COM 2 ports have 2.5kV isolated protection and support RS232/422/485 compatible serial devices.  
COM 3 supports RS232 and 5V, 12V or RI by selection.

### **VGA**

Used to connect an analog VGA monitor.

### **LAN**

Used to connect the system to a local area network. LAN1 supports Wake up on LAN.

### **USB**

Used to connect USB 2.0/1.1 devices.

### **Audio Connectors**

Line-in, mic-in and line-out ports used to connect audio devices such as external microphones, speakers and headphones.

## Knowing Your APPC 1560T

### APPC 1560T Rear Top

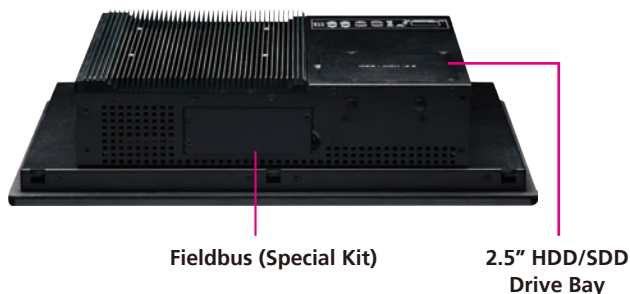

#### Fieldbus (Special Kit)

Expansion slots for add-on fieldbus modules.

#### 2.5" HDD/SDD Drive Bay

Used to install a 2.5" HDD/SSD.

#### Power Switch

Press to power-on or power-off the system.

#### Reset Switch

Press this button to restart the system.

#### AC Input

Used to plug a AC power cord.

#### PS/2 KB/MS

Used to connect a PS/2 keyboard and a PS/2 mouse.

#### COM 1 to COM 3

COM 1 and COM 2 ports have 2.5kV isolated protection and support RS232/422/485 compatible serial devices. COM 3 supports RS232 and 5V, 12V or RI by selection.

#### VGA

Used to connect an analog VGA monitor.

#### LAN

Used to connect the system to a local area network. LAN1 supports Wake up on LAN.

#### USB

Used to connect USB 2.0/1.1 devices.

#### Audio Connectors

Line-in, mic-in and line-out ports used to connect audio devices such as external microphones, speakers and headphones.

### APPC 1560T Rear Bottom

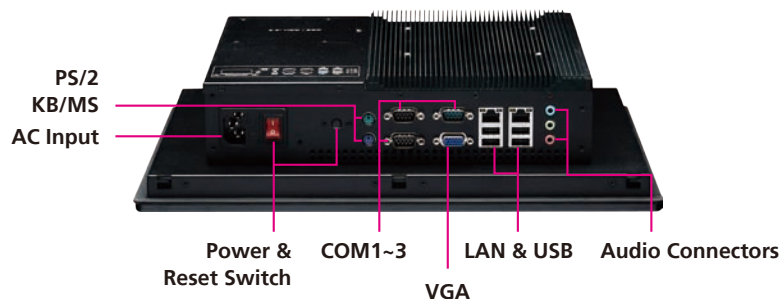

## IPPC 1560T Series Rear



### VESA Mounting Holes

These are mounting holes for VESA mount (100x100mm)

## IPPC 1960T Series Rear



### VESA Mounting Holes

These are mounting holes for VESA mount (100x100mm)

## IPPC 2160P Rear

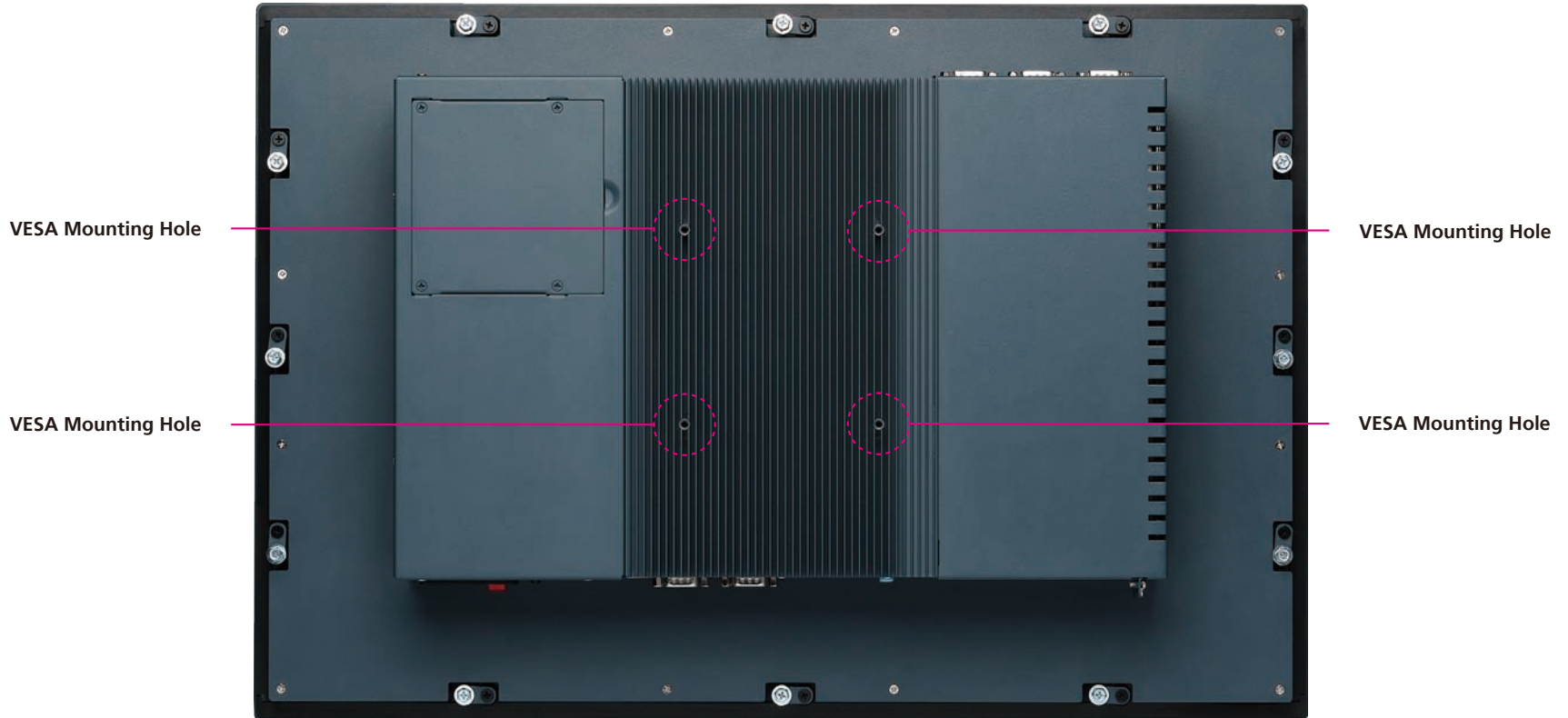

### VESA Mounting Holes

These are mounting holes for VESA mount (100x100mm)

## APPC 1560T Rear



### VESA Mounting Holes

These are mounting holes for VESA mount (100x100mm)



# Mechanical Dimensions

## IPPC 1560TP2E-DC

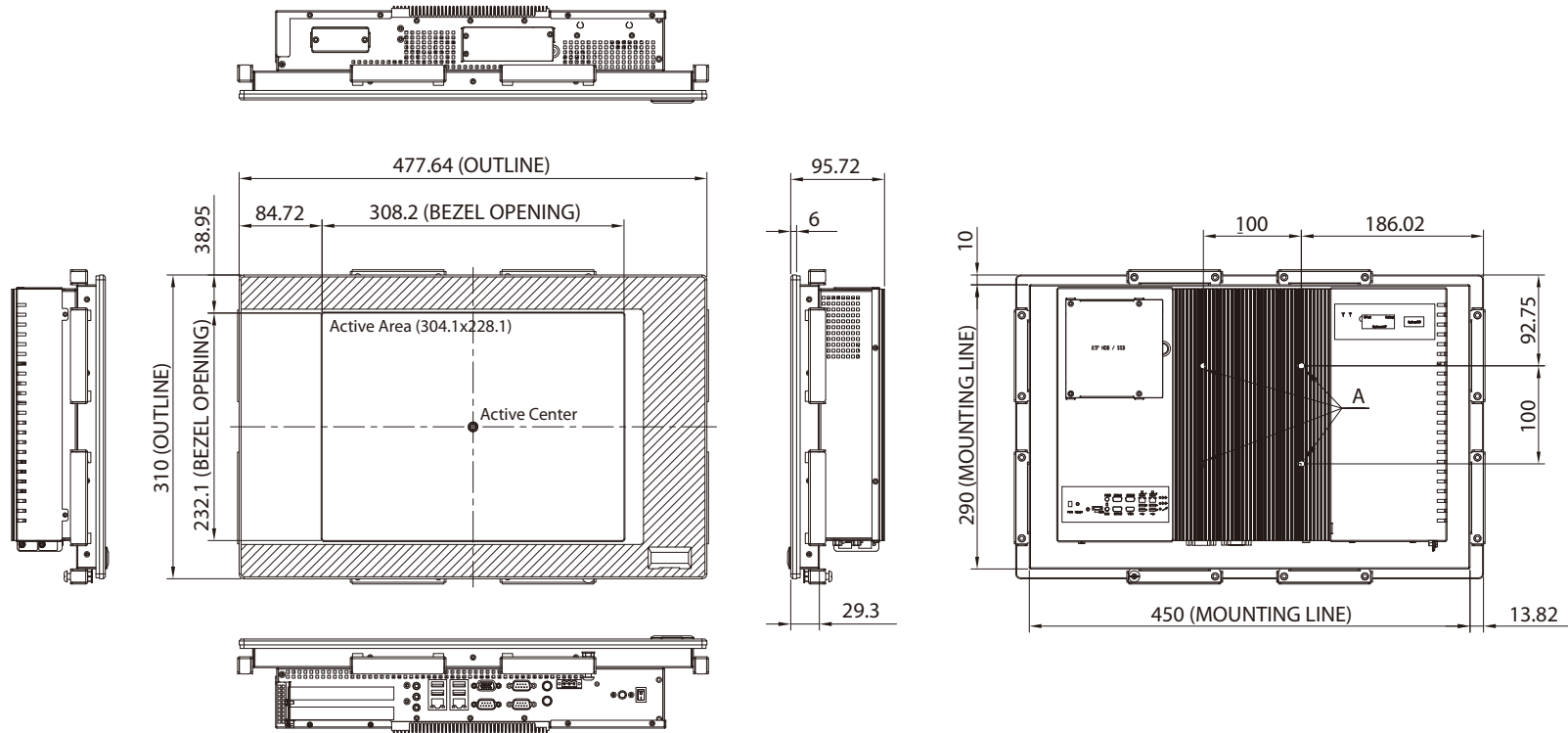

## IPPC 1560TP2E-AC

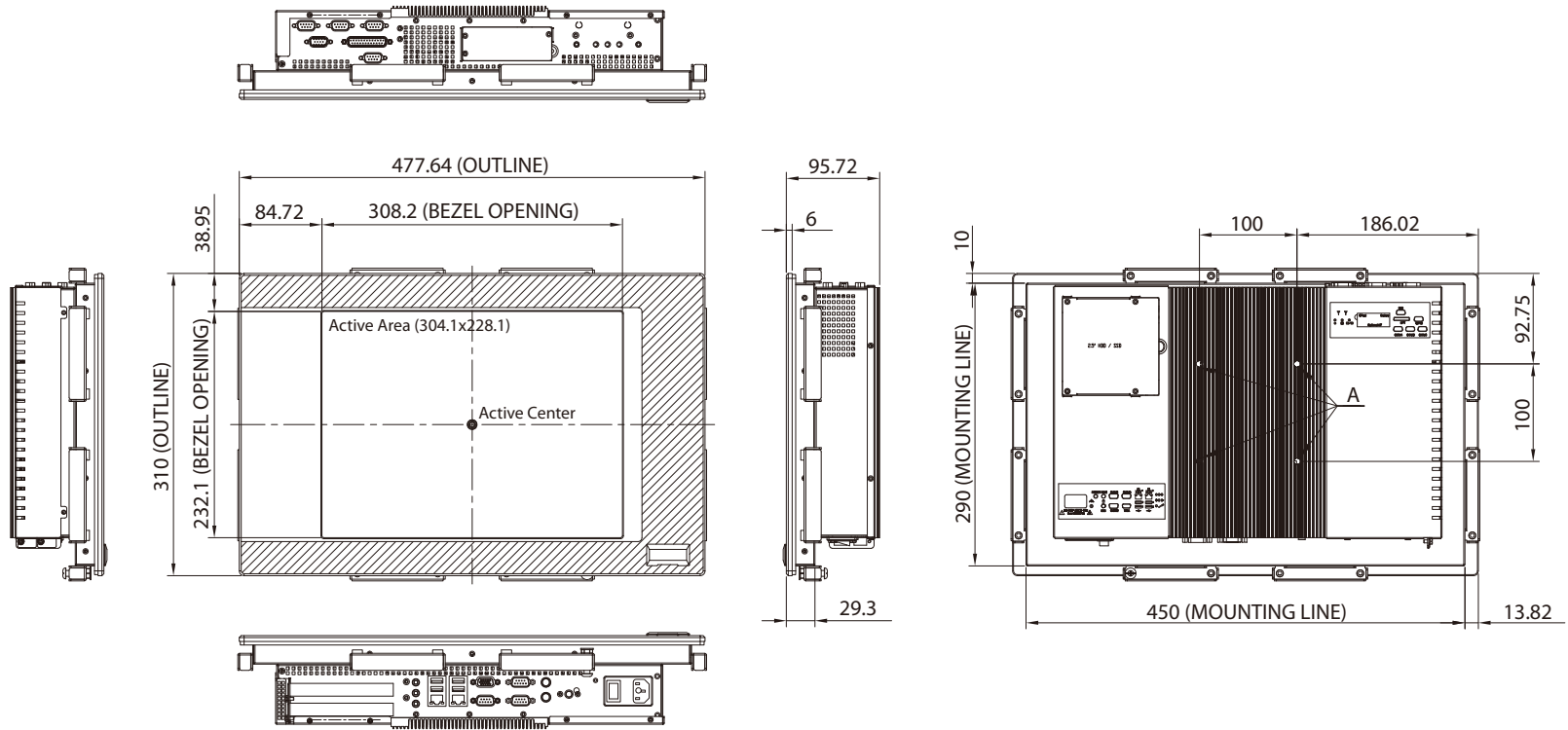

# IPPC 1560TE

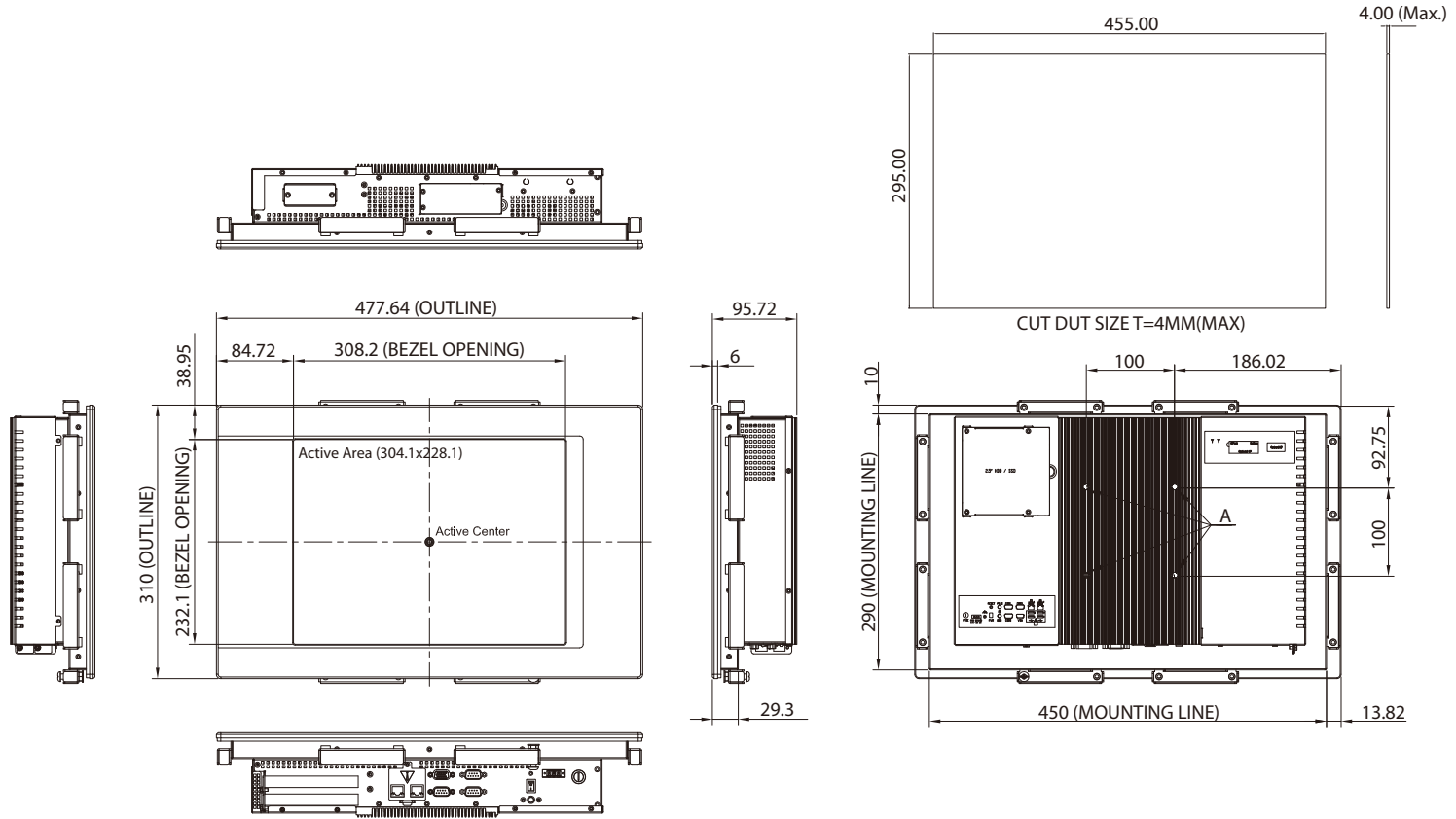

## IPPC 1960TP2E-DC

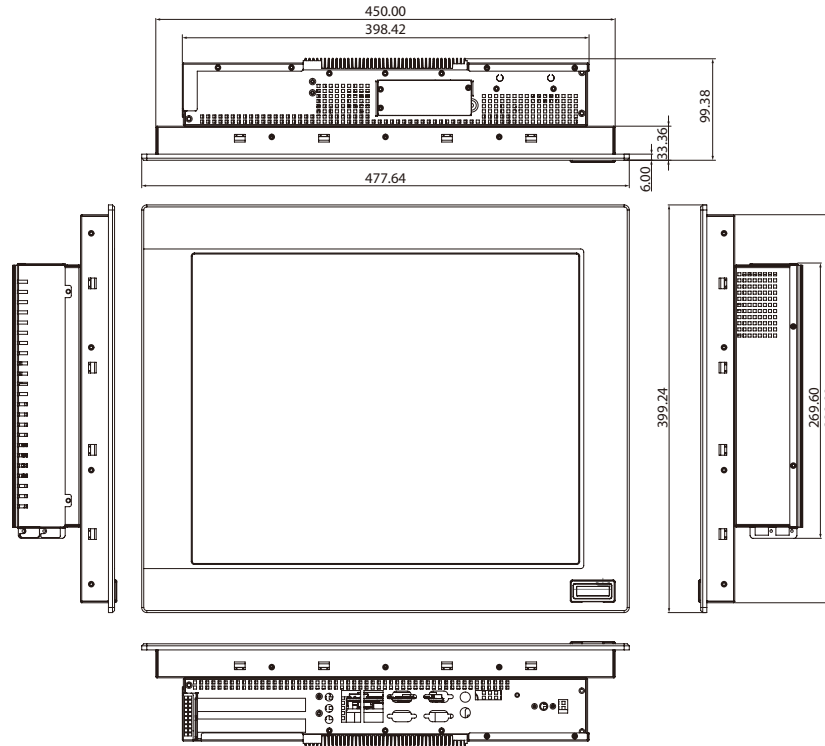

## IPPC 1960TP2E-AC

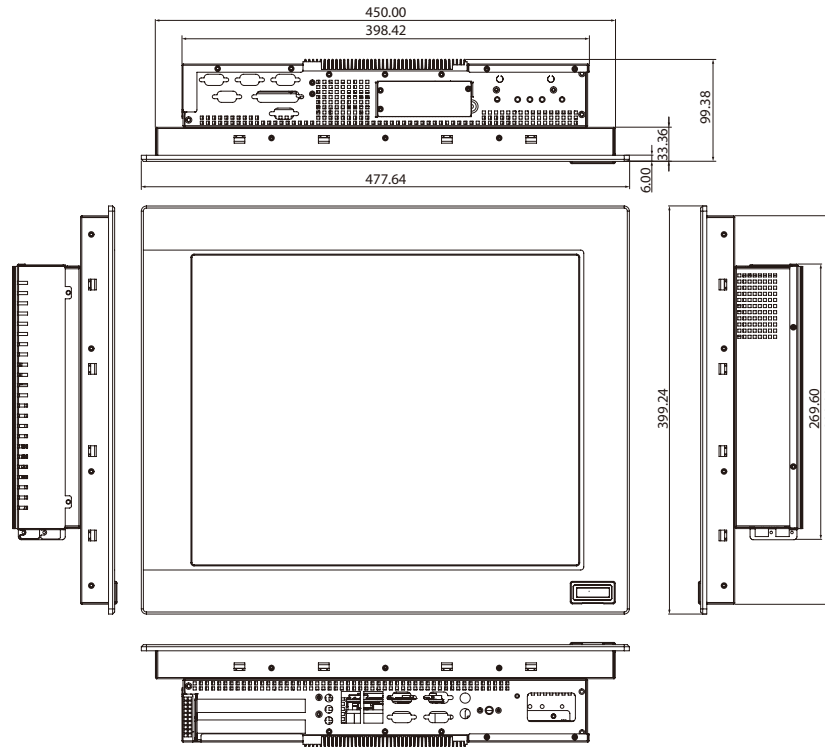

## IPPC 2160P

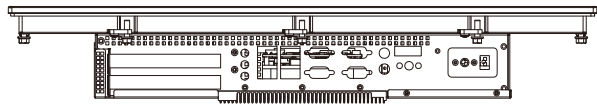
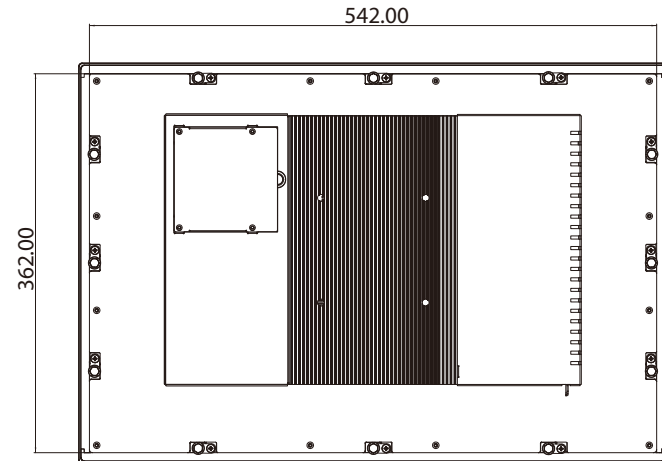
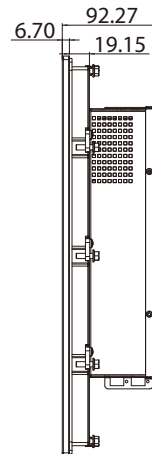
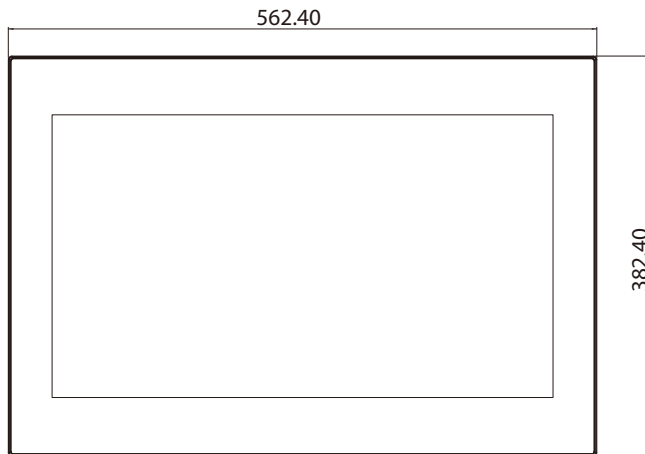
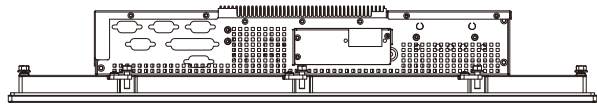

## APPC 1560T

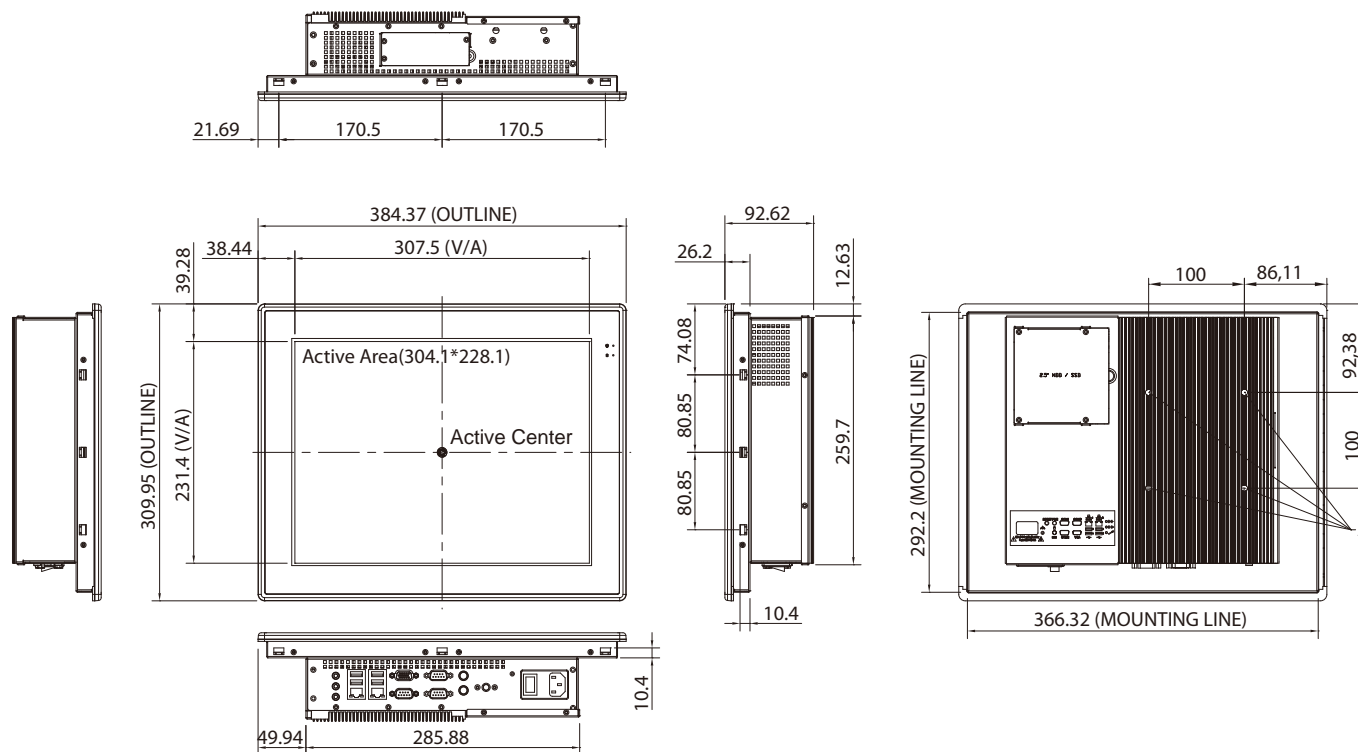

# Chapter 2: Jumpers and Connectors

This chapter describes how to set the jumpers and connectors on the motherboard in the IPPC 1560T/1960T/2160P series and APPC 1560T.

## Before You Begin

- Ensure you have a stable, clean working environment. Dust and dirt can get into components and cause a malfunction. Use containers to keep small components separated.
- Adequate lighting and proper tools can prevent you from accidentally damaging the internal components. Most of the procedures that follow require only a few simple tools, including the following:
  - A Philips screwdriver
  - A flat-tipped screwdriver
  - A set of jewelers screwdrivers
  - A grounding strap
  - An anti-static pad
- Using your fingers can disconnect most of the connections. It is recommended that you do not use needle-nosed pliers to disconnect connections as these can damage the soft metal or plastic parts of the connectors.
- Before working on internal components, make sure that the power is off. Ground yourself before touching any internal components, by touching a metal object. Static electricity can damage many of the electronic components. Humid environments tend to have less static electricity than

dry environments. A grounding strap is warranted whenever danger of static electricity exists.

## Precautions

Computer components and electronic circuit boards can be damaged by discharges of static electricity. Working on computers that are still connected to a power supply can be extremely dangerous.

Follow the guidelines below to avoid damage to your computer or yourself:

- Always disconnect the unit from the power outlet whenever you are working inside the case.
- If possible, wear a grounded wrist strap when you are working inside the computer case. Alternatively, discharge any static electricity by touching the bare metal chassis of the unit case, or the bare metal body of any other grounded appliance.
- Hold electronic circuit boards by the edges only. Do not touch the components on the board unless it is necessary to do so. Don't flex or stress the circuit board.
- Leave all components inside the static-proof packaging that they shipped with until they are ready for installation.
- Use correct screws and do not over tighten screws.



## Jumper Settings

A jumper is the simplest kind of electric switch. It consists of two metal pins and a cap. When setting the jumpers, ensure that the jumper caps are placed on the correct pins. When the jumper cap is placed on both pins, the jumper is short. If you remove the jumper cap, or place the jumper cap on just one pin, the jumper is open.

Refer to the illustrations below for examples of what the 2-pin and 3-pin jumpers look like when they are short (on) and open (off).

Two-Pin Jumpers: Open (Left) and Short (Right)

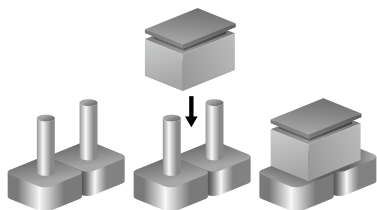

Three-Pin Jumpers: Pins 1 and 2 are Short

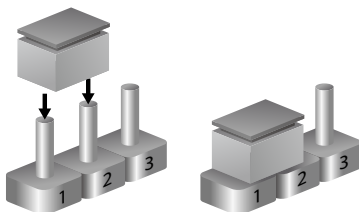

# Locations of the Jumpers and Connectors

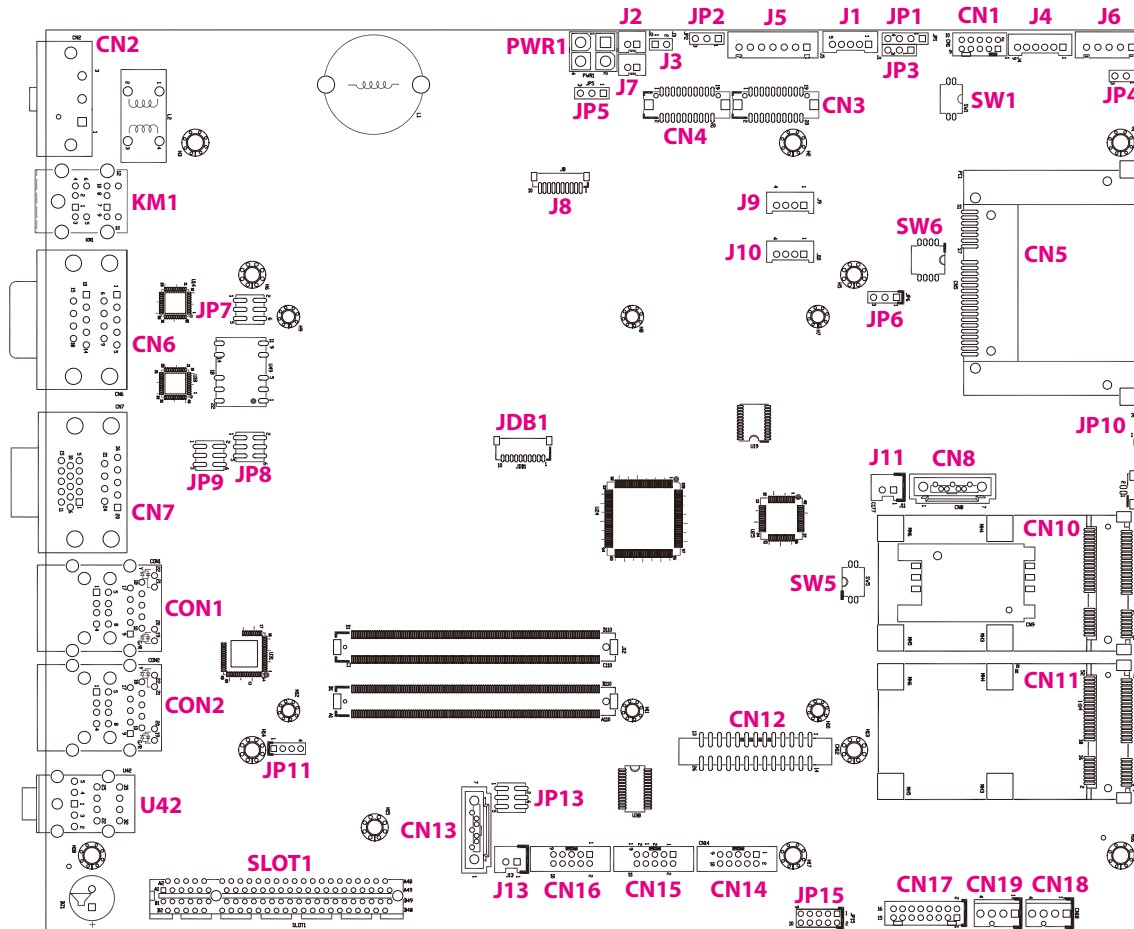

## Jumpers and DIP Switch Settings

### AT/ATX Power Type Select

Connector type: 1x3 3-pin header, 2.54mm pitch

Connector location: JP5



Pin	Settings
1-2 On	AT
2-3 On	ATX

Pin	Definition
1	ATMODE
2	MODE_SEL
3	ATXMODE

### LCD Power Select

Connector type: 1x3 3-pin header, 2.54mm pitch

Connector location: JP2



Pin	Settings
1-2 On	VCC3
2-3 On	VCC5

1-2 On: default

Pin	Definition
1	VCC3
2	VCCLCDIN
3	VCC5

## CCFL Power Select

Connector type: 1x3 3-pin header, 2.54mm pitch  
Connector location: JP3



Pin	Settings
1-2 On	VCC3
2-3 On	VCC5

1-2 On: default

Pin	Definition
1	VCC3
2	P_BKLTCTRL3
3	VCC5

## Touch Panel Type Select

Connector type: 1x3 3-pin header, 2.54mm pitch  
Connector location: JP4



Pin	Settings
1-2 On	5 Wire
2-3 On	4 Wire

1-2 On: default

Pin	Definition
1	NC
2	TOUCH_YU
3	SENSE

## CMOS Clear Select

Connector type: 1x3 3-pin header, 2.54mm pitch

Connector location: JP10



Pin	Settings
1-2 On	Normal
2-3 On	Clear CMOS

1-2 On: default

Pin	Definition
1	3VSB
2	VBAT
3	GND

## RI Feature Selection (COM1)

Connector type: 2x3 6-pin header, 2.0mm pitch

Connector location: JP7

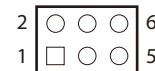

Pin	Settings
1-2 On	RI (Default)
3-4 On	VCC5
5-6 On	+12V

1-2 On: default

Pin	Definition	Pin	Definition
1	SP1_PSRI#	2	SP1_RI#
3	SP1_PSRI#	4	ISO_VCC5
5	SP1_PSRI#	6	ISO_+12V

## RI Feature Selection (COM2)

Connector type: 2x3 6-pin header, 2.0mm pitch

Connector location: JP8

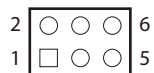

Pin	Settings
1-2 On	RI (Default)
3-4 On	VCC5
5-6 On	+12V

1-2 On: default

Pin	Definition	Pin	Definition
1	SP2_PSRI#	2	SP2_RI#
3	SP2_PSRI#	4	ISO_VCC5_A
5	SP2_PSRI#	6	ISO_+12V

## RI Feature Selection (COM3)

Connector type: 2x3 6-pin header, 2.0mm pitch

Connector location: JP9

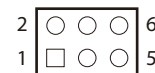

Pin	Settings
1-2 On	RI (Default)
3-4 On	VCC5
5-6 On	+12V

1-2 On: default

Pin	Definition	Pin	Definition
1	SP3_PSRI#	2	SP3_RI#
3	SP3_PSRI#	4	ISO_VCC5
5	SP3_PSRI#	6	ISO_+12V

### RI Feature Selection (COM4)

Connector type: 2x3 6-pin header, 2.0mm pitch

Connector location: JP13

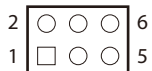

Pin	Settings
1-2 On	RI (Default)
3-4 On	VCC5
5-6 On	+12V

1-2 On: default

Pin	Definition	Pin	Definition
1	SP4_PSRI#	2	SP4_RI#
3	SP4_PSRI#	4	ISO_VCC5
5	SP4_PSRI#	6	ISO_+12V

### Dimming Type Select

Connector type: 2-pin DIP switch

Connector location: SW1

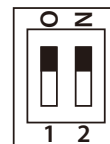

SW1-1	SW1-2	Settings
OFF	ON	CCFL Mode
ON	OFF	PWM Mode

Pin	Definition	Pin	Definition
1	PWM_dimming	2	CCFL_dimming
3	PL_BKLTCTRL	4	PL_BKLTCTRL

## LVDS Resolution Select

Connector type: 2-pin DIP switch

Connector location: SW5

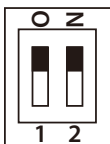

SW5-1	SW5-2	Resolution
OFF	OFF	1024 x 768
ON	OFF	1280 x 1024
OFF	ON	1366 x 768
ON	ON	1920 x 1080

## PWN Reverse/Function Key Dimming Select

Connector type: 4-pin DIP switch

Connector location: SW6



SW6-1	SW6-2	SW6-3	SW6-4	Settings
ON	OFF	X	X	PWN Dimming
OFF	ON	X	X	PWN Dimming Reverse
X	X	ON	OFF	IPPC Dimming
X	X	OFF	ON	MPPC Dimming



## Connector Pin Definitions

### External I/O Interfaces

#### Keyboard/Mouse Ports

Connector type: PS/2, Mini-DIN6

Connector location: KM1

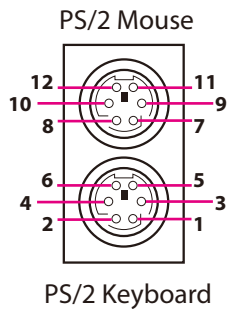

Pin	Definition	Pin	Definition
1	KDAT	2	NC
3	GND	4	5VSB
5	KCLK	6	NC
7	MDAT	8	NC
9	GND	10	5VSB
11	MCLK	12	NC

### COM 1 and COM 2 Ports

Connector type: DB-9 port, 9-pin D-Sub

Connector location: CN6A (COM1) and CN6B (COM2)

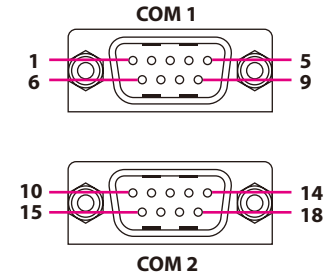

Pin	Definition	Pin	Definition
1	DCD1	2	RXD1
3	TXD1	4	DTR1
5	GND	6	DSR1
7	RTS1	8	CTS1
9	RI1	10	DCD2
11	RXD2	12	TXD2
13	DTR2	14	GND
15	DSR2	16	RTS2
17	CTS2	18	RI2

### COM 3 and VGA Port

Connector type: DB-9 port, 9-pin D-Sub (COM)  
 DB-15 port, 15-pin D-Sub (VGA)  
 Connector location: CN7A (COM3) and CN7B (VGA)

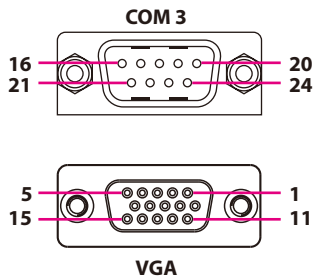

Pin	Definition	Pin	Definition
1	RED_VGA	2	GREEN_VGA
3	BLUE_VGA	4	NC
5	GND	6	VGADET
7	GND	8	GND
9	VCC5	10	NC
11	NC	12	DDCDATA_VGA
13	HSYNC_VGA	14	VSYNC_VGA
15	DDCCLK_VGA	16	DCD3
17	RXD3	18	TXD3
19	DTR3	20	GND
21	DSR3	22	RTS3
23	CTS3	24	RI3

### LAN 1 and USB Ports

Connector type: RJ45 port with LEDs  
 Dual USB 2.0 ports, Type A  
 Connector location: CON1A (USB0/1) and CON1B (LAN1)

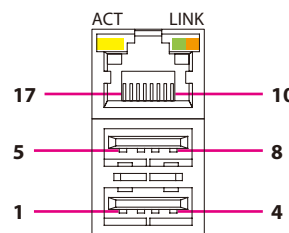

Act	Status
Flashing Yellow	Data activity
Off	No activity

Link	Status
Steady Green	1G network link
Steady Orange	100Mbps network link
Off	No link

Pin	Definition	Pin	Definition
1	5VSB	2	USB_0N
3	USB_0P	4	GND
5	5VSB	6	USB_1N
7	USB_1P	8	GND
9	V25_LAN1	10	LAN1_MDI0P
11	LAN1_MDI0N	12	LAN1_MDI1P
13	LAN1_MDI1N	14	LAN1_MDI2P
15	LAN1_MDI2N	16	LAN1_MDI3P
17	LAN1_MDI3N	18	GND
19	LAN1_LED3P	20	LAN1_LED2P
21	LAN1_ACTLED#	22	LAN1_LED1P

## LAN 2 and USB Ports

Connector type: RJ45 port with LEDs

Dual USB 2.0 ports, Type A

Connector location: CON2A (USB0/1) and CON2B (LAN2)

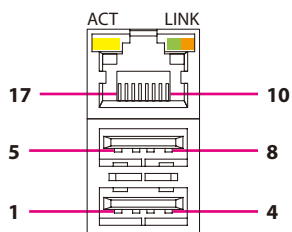

Act	Status
Flashing Yellow	Data activity
Off	No activity

Link	Status
Steady Green	1G network link
Steady Orange	100Mbps network link
Off	No link

Pin	Definition	Pin	Definition
1	5VSB	2	USB_2N
3	USB_2P	4	GND
5	5VSB	6	HUBUSB_DN3
7	HUBUSB_DP3	8	GND
9	LAN2P1V9	10	LAN2_MDI0P
11	LAN2_MDI0N	12	LAN2_MDI1P
13	LAN2_MDI1N	14	LAN2_MDI2P
15	LAN2_MDI2N	16	LAN2_MDI3P
17	LAN2_MDI3N	18	GND
19	LAN2_LED3P	20	LAN2_LED2P
21	LAN2_ACTLED#	22	LAN2_LED1P

## Audio Connectors

Connector type: 3.5mm Earphone Jack

Connector location: U42A (MIC), U42B (Line-out) and U42C (Line-in)

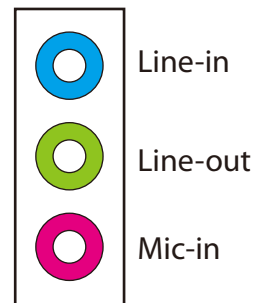

Pin	Definition	Pin	Definition
1	GND	2	MIC1-L
3	MIC-JD	4	GND
5	MIC1_R3	22	LINE_OUT_L
23	FRONT-JD	24	GND
25	LINE_OUT_R	32	LINE1-L
33	LINE1-JD	34	GND
35	LINE1-R		

## Connector Pin Definitions

### Internal Connectors

#### PoE Power Connector

Connector type: 2x2 4-pin connector, 4.2mm pitch

Connector location: PWR1

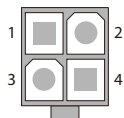

Pin	Definition	Pin	Definition
1	GND	2	GND
3	VIN	4	VIN

#### Power Button

Connector type: 1x2 JST, 2-pin header, 2.0mm pitch

Connector location: J2



Pin	Definition
1	PWRBTN#
2	GND

### DC Power Button (AT)

Connector type: 1x2 2-pin header, 2.54mm pitch  
 Connector location: J3



Pin	Definition
1	AT_IN
2	VIN_M

### COM 4

Connector type: 2x5 10-pin header, 2.0mm pitch  
 Connector location: CN16

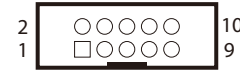

Pin	Definition	Pin	Definition
1	DCD4	2	RXD4
3	TXD4	4	DTR4
5	GND	6	DSR4
7	RTS4	8	CTS4
9	RI4	10	GND

## COM 5

Connector type: 2x5 10-pin header, 2.0mm pitch

Connector location: CN15



Pin	Definition	Pin	Definition
1	DCD5	2	RXD5
3	TXD5	4	DTR5
5	GND	6	DSR5
7	RTS5	8	CTS5
9	RI5	10	GND

## COM 6

Connector type: 2x5 10-pin header, 2.0mm pitch

Connector location: CN14



Pin	Definition	Pin	Definition
1	DCD6	2	RXD6
3	TXD6	4	DTR6
5	GND	6	DSR6
7	RTS6	8	CTS6
9	RI6	10	GND

## USB Connectors

Connector type: 1x4 4-pin header JST, 2.0mm pitch

Connector location: J9 & J10

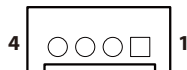

Pin	Definition	Pin	Definition
1	5VSB	2	HUBUSB_DN1
3	HUBUSB_DP1	4	GND

## Speaker-out Connector

Connector type: 1x4 4-pin header, 2.0mm pitch

Connector location: JP11



Pin	Definition	Pin	Definition
1	AUDIO-OUT-LR+	2	AUDIO-OUT-LR-
3	AUDIO-OUT-RR+	4	AUDIO-OUT-RR-

## CFast Card Slot

Connector type: Standard CFast connector

Connector location: CN5

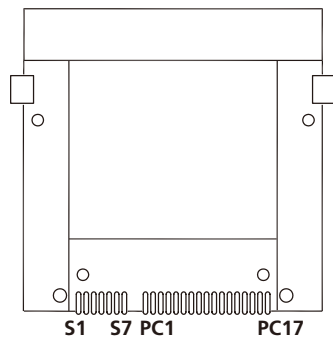

Pin	Definition	Pin	Definition
S1	GND	PC6	NC
S2	SATA_TXP2	PC7	GND
S3	SATA_TXN2	PC8	TEST POINT
S4	GND	PC9	NC
S5	SATA_RXN2	PC10	NC
S6	SATA_RXP2	PC11	NC
S7	GND	PC12	NC
PC1	GND	PC13	+3.3V
PC2	GND	PC14	+3.3V
PC3	NC	PC15	GND
PC4	NC	PC16	GND
PC5	NC	PC17	NC

## SATA Connector

Connector type: Standard Serial ATA, 1.27mm pitch

Connector location: CN8

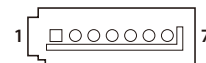

Pin	Definition	Pin	Definition
1	GND	2	SATA_TXP0
3	SATA_TXN0	4	GND
5	SATA_RXN0	6	SATA_RXP0
7	GND		



## SATA Connector

Connector type: Standard Serial ATA, 1.27mm pitch

Connector location: CN13

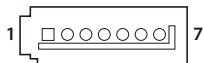

Pin	Definition	Pin	Definition
1	GND	2	SATA_TXP1
3	SATA_TXN1	4	GND
5	SATA_RXN1	6	SATA_RXP1
7	GND		

## SATA Power Connector

Connector type: 1x2 JST, 2-pin header, 2.5mm pitch

Connector location: J11



Pin	Definition
1	VCC5
2	GND

## SATA Power Connector

Connector type: 1x2 JST, 2-pin header, 2.5mm pitch

Connector location: J13



Pin	Definition
1	VCC5
2	GND

## LVDS Connector A

Connector type: 2x10 20-pin header, 1.25mm pitch

Connector location: CN3

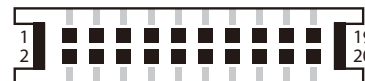

Pin	Definition	Pin	Definition
1	LVDS_DDC_CLK	2	LVDS_DDC_DATA
3	Panel_VDD	4	LVDSA_DATA0
5	LVDSA_DATA3	6	LVDSA_DATA#0
7	LVDSA_DATA#3	8	Panel_VDD
9	GND	10	LVDSA_DATA1
11	LVDSA_CLK	12	LVDSA_DATA#1
13	LVDSA_CLK#	14	GND
15	GND	16	Panel_backlight
17	LVDSA_DATA2	18	Panel_backlight
19	LVDSA_DATA#2	20	GND

## LVDS Connector B

Connector type: 2x10 20-pin header, 1.25mm pitch

Connector location: CN4

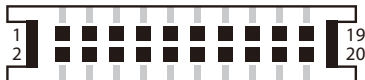

Pin	Definition	Pin	Definition
1	LVDS_DDC_CLK	2	LVDS_DDC_DATA
3	Panel_VDD	4	LVDSB_DATA0
5	LVDSB_DATA3	6	LVDSB_DATA#0
7	LVDSB_DATA#3	8	Panel_VDD
9	GND	10	LVDSB_DATA1
11	LVDSB_CLK	12	LVDSB_DATA#1
13	LVDSB_CLK#	14	GND
15	GND	16	Panel_backlight
17	LVDSB_DATA2	18	Panel_backlight
19	LVDSB_DATA#2	20	GND

## LVDS Panel Inverter Connector

Connector type: 1x7 JST, 7-pin header, 2.5mm pitch

Connector location: J5

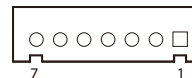

Pin	Definition	Pin	Definition
1	VCC5	2	+12V
3	+12V	4	Panel Backlight Brightness Control
5	GND	6	GND
7	Panel Backlight Enable		

## Touch Panel Control Connector

Connector type: 1x5 5-pin header JST, 2.54mm pitch

Connector location: J6

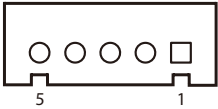

Pin	4-wire	5-wire
1	Left	LL (L)
2	Top	UL (Y)
3	N/A	Sense (S)
4	Right	LR (X)
5	Bottom	UR (H)

Pin	Definition	Pin	Definition
1	TOUCH_YD	2	TOUCH_XR
3	SENSE	4	TOUCH_YU
5	TOUCH_XL		

## SATA/Power LED

Connector type: 1x5 5-pin header JST, 2.0mm pitch

Connector location: J1



Pin	Definition	Pin	Definition
1	HDDLED#	2	HDDLED
3	GND	4	STBYLED
5	PWRLED		

## MCU Debug I/F

Connector type: 1x4 4-pin header, 2.54mm pitch

Connector location: JP1



Pin	Definition	Pin	Definition
1	VCC3	2	MCU_SBWTK
3	MCU_SBWTDIO	4	GND

## MCU LED Indicator Connector

Connector type: 2x5 10-pin header, 2.0mm pitch

Connector location: CN1

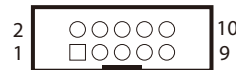

Pin	Definition	Pin	Definition
1	MCU_LSENPW	2	MCU_LED_5
3	MCU_LSEN	4	MCU_LED_4
5	MCU_PIRC	6	MCU_LED_3
7	MCU_BKC	8	MCU_LED_2
9	GND	10	MCU_LED_1

## Function Key-in Connector

Connector type: 1x6 6-pin header JST, 2.0mm pitch

Connector location: J4



Pin	Definition	Pin	Definition
1	MCU_KEYIN_1	2	MCU_SCAN_1
3	MCU_SCAN_2	4	MCU_SCAN_3
5	MCU_SCAN_4	6	MCU_SCAN_5

## System FAN2 Connector

Connector type: 1x4 4-pin Wafer, 2.54mm pitch

Connector location: CN19

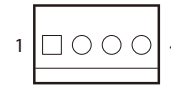

Pin	Definition	Pin	Definition
1	GND	2	12V
3	FANIN	4	FANOUT

## System FAN1 Connector

Connector type: 1x4 4-pin Wafer, 2.54mm pitch

Connector location: CN18

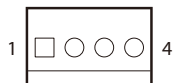

Pin	Definition	Pin	Definition
1	GND	2	12V
3	SYSFANIN	4	SYSFANOUT

## Reset Button

Connector type: 1x2 JST, 2-pin header, 2.0mm pitch

Connector location: J7



Pin	Definition
1	HW_R_RST#
2	GND

## Bluetooth Connector

Connector type: 1x10 10-pin header JST, 1.0mm pitch

Connector location: J8



Pin	Definition	Pin	Definition
1	GND	2	USB_6P
3	USB_6N	4	NC
5	NC	6	BT_AUDIO_EN
7	NC	8	BT_3.3V
9	NC	10	GND

## Digital I/O

Connector type: 2x8 16-pin header, 2.54mm pitch

Connector location: CN17

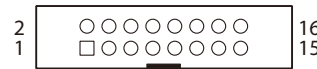

Pin	Definition	Pin	Definition
1	D10	2	DO0
3	D11	4	DO1
5	D12	6	DO2
7	D13	8	DO3
9	NC	10	NC
11	COM1	12	NC
13	GND	14	GND
15	GND	16	GND



## GPIO

Connector type: 2x5 10-pin header, 2.0mm pitch

Connector location: JP15

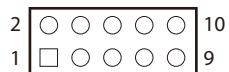

Pin	Definition	Pin	Definition
1	VCC5	2	GND
3	ICH_GPO0_OUT	4	ICH_GPIO_IN
5	ICH_GPO1_OUT	6	ICH_GPI1_IN
7	ICH_GPO2_OUT	8	ICH_GPI2_IN
9	ICH_GPO3_OUT	10	ICH_GPI3_IN

## Bluetooth Connector

Connector type: 1x10 10-pin header JST, 1.0mm pitch

Connector location: JDB1



Pin	Definition	Pin	Definition
1	GND	2	SIO_RESET#
3	LPC_PORT80_CLK	4	LPC_FRAME#
5	LPC_AD3	6	LPC_AD2
7	LPC_AD1	8	LPC_AD0
9	VCC3	10	VCC3

## Parallel Port Box Header

Connector type: 2x13 26-pin header, 2.0mm pitch

Connector location: CN12



Pin	Definition	Pin	Definition
1	Line Print Strobe	2	Parallel Data 0
3	Parallel Data 1	4	Parallel Data 2
5	Parallel Data 3	6	Parallel Data 4
7	Parallel Data 5	8	Parallel Data 6
9	Parallel Data 7	10	Acknowledge#
11	Busy	12	Paper empty
13	Select	14	Auto Feed#
15	Error#	16	Initialize#
17	Select Input#	18	GND
19	GND	20	GND
21	GND	22	GND
23	GND	24	GND
25	GND	26	NC

## Mini-PCIe Connector

Connector location: CN10

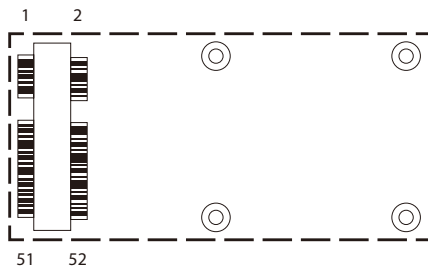

Pin	Definition	Pin	Definition
1	WAKE#	2	+3VSB
3	NC	4	GND
5	NC	6	+1.5V
7	CLKREQ#	8	UIM_PWR
9	GND	10	UIM_DATA
11	REF CLK-	12	UIM_CLK
13	REF CLK+	14	UIM_RESET
15	GND	16	UIM_VPP
17	NC	18	GND
19	NC	20	Disable#
21	GND	22	PERST#
23	PCIERX1N	24	+3VSB
25	PCIERX1P	26	GND

Pin	Definition	Pin	Definition
27	GND	28	+1.5V
29	GND	30	SMBCLK
31	PCIETX-	32	SMBDATA
33	PCIETX+	34	GND
35	GND	36	USB_5N
37	GND	38	USB_5P
39	+3VSB	40	GND
41	+3VSB	42	NC
43	GND	44	NC
45	NC	46	NC
47	NC	48	+1.5V
49	NC	50	GND
51	NC	52	+3VSB

## Mini-PCIe Connector

Connector location: CN11

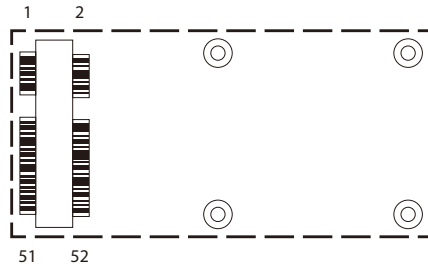

Pin	Definition	Pin	Definition
1	WAKE#	2	+3VSB
3	NC	4	GND
5	NC	6	+1.5V
7	CLKREQ#	8	UIM_PWR
9	GND	10	UIM_DATA
11	REF CLK-	12	UIM_CLK
13	REF CLK+	14	UIM_RESET
15	GND	16	UIM_VPP
17	NC	18	GND
19	NC	20	Disable#
21	GND	22	PERST#
23	PCIERX1N	24	+3VSB
25	PCIERX1P	26	GND

Pin	Definition	Pin	Definition
27	GND	28	+1.5V
29	GND	30	SMBCLK
31	PCIETX-	32	SMBDATA
33	PCIETX+	34	GND
35	GND	36	USB_5N
37	GND	38	USB_5P
39	+3VSB	40	GND
41	+3VSB	42	NC
43	GND	44	NC
45	NC	46	NC
47	NC	48	+1.5V
49	NC	50	GND
51	NC	52	+3VSB

# Chapter 3: System Setup

## Installing a Primary SATA Hard Drive



Prior to removing the chassis cover, make sure the unit's power is off and disconnected from the power sources to prevent electric shock or system damage.

1. Remove the 4 screws around the HDD cover.

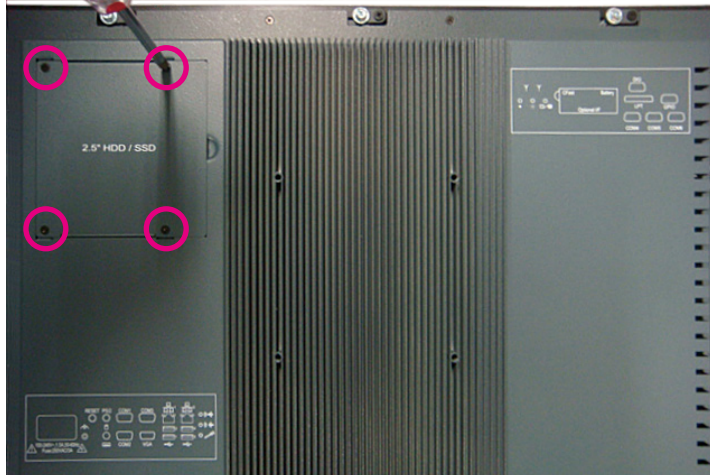

2. Remove the HDD cover.



3. Remove the mounting screws on the drive bay.

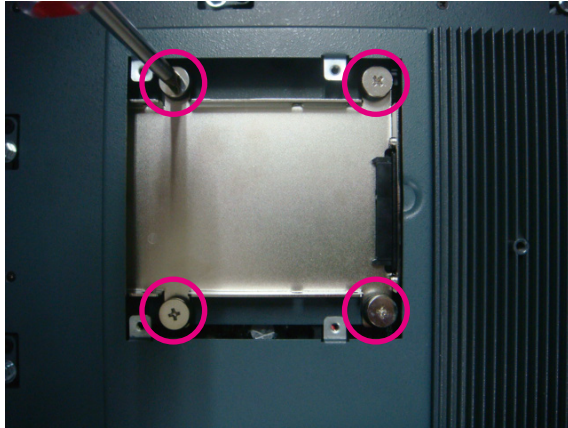

4. Push toward right and pull up the drive bay.

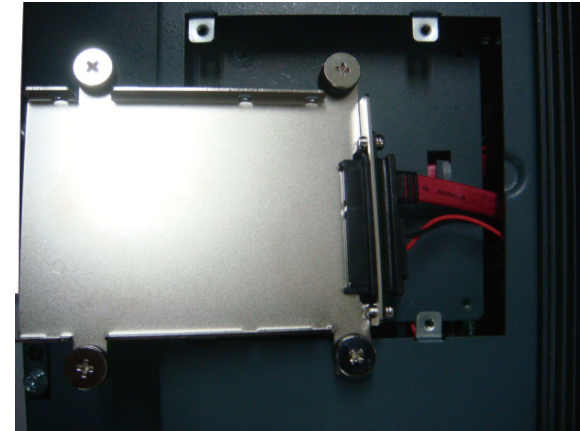

5. Place the SATA hard drive on the drive bay.

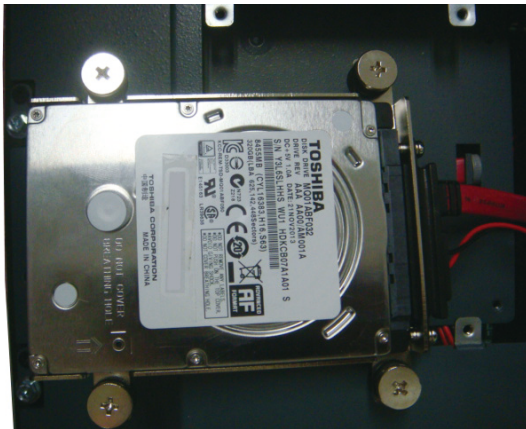

6. Use the provided mounting screws to secure the drive in place.

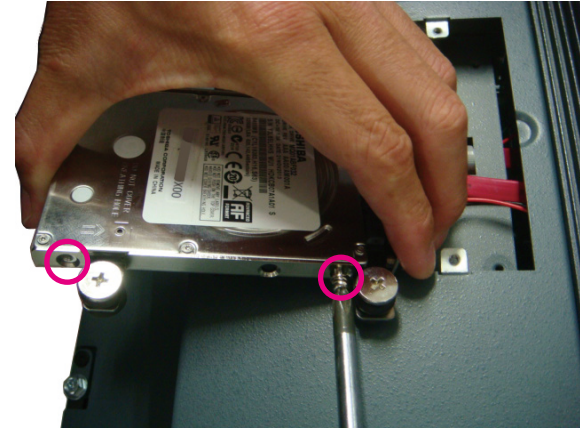



7. Push toward right then push down the drive bay into the chassis.



8. Secure the drive bay in the chassis and secure the HDD cover.





## Installing a Secondary SATA Hard Drive

1. Remove the 6 screws on the right back cover.

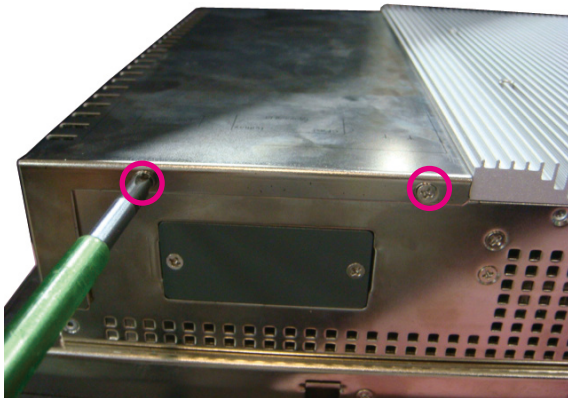
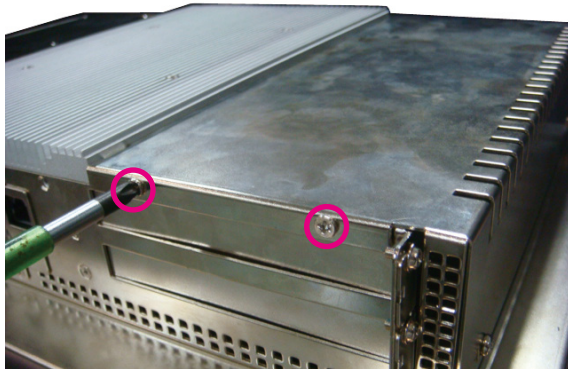

2. Remove the mounting screws on the drive bay.

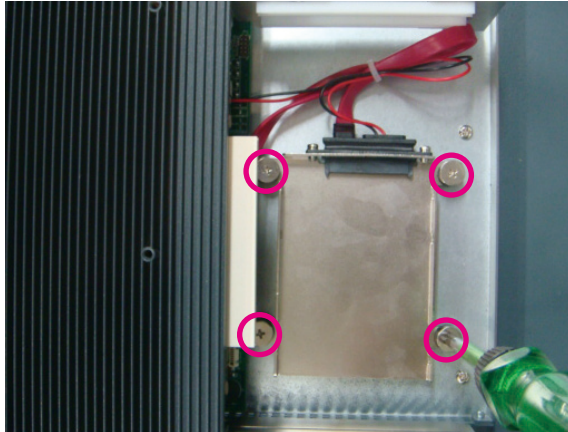

3. Place the SATA hard drive on the drive bay.

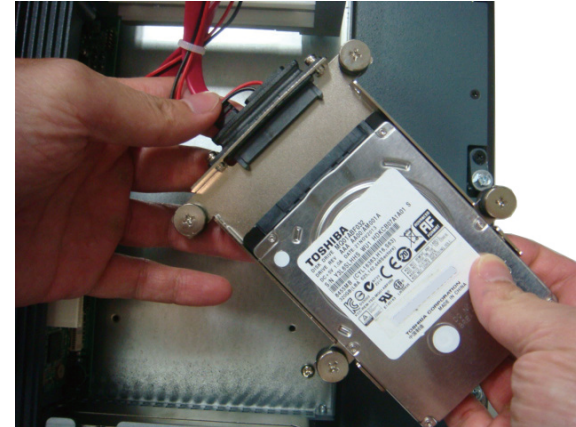

4. Use the provided mounting screws to secure the drive in place.

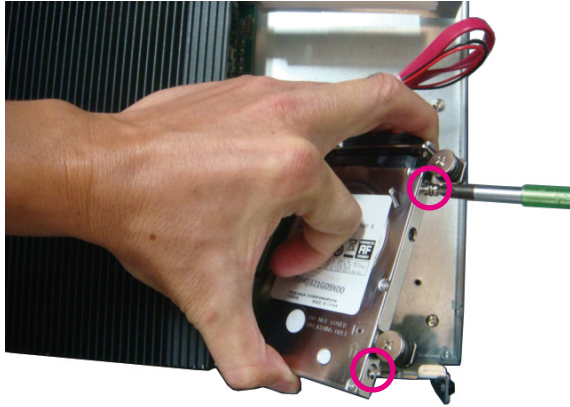

5. Secure the drive bay in the chassis and replace the right back cover.

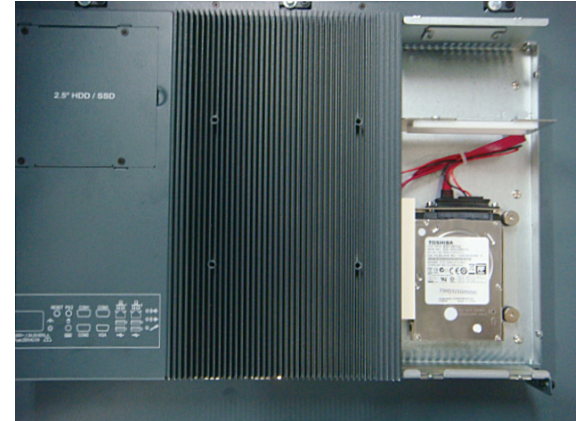

## Installing a CFast Card

1. The CFast card is located on the rear top side of the chassis. Remove this cover to install CFast card and change battery. Change this cover to support other interface connector, such as fieldbus.



2. Remove the mounting screw on the cover.

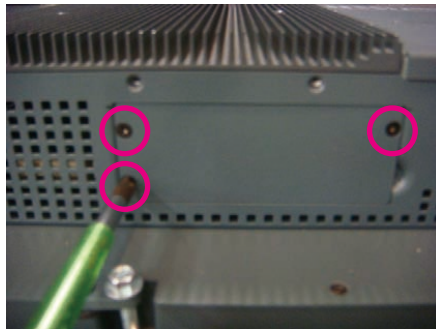

3. Insert the CFast card until it is completely seated in the socket.

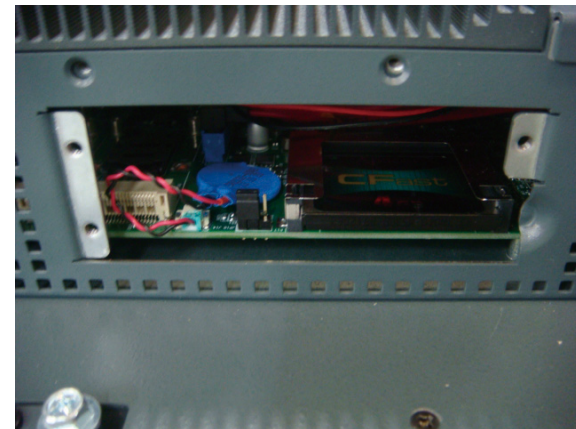



4. Push the CFast card to remove it.

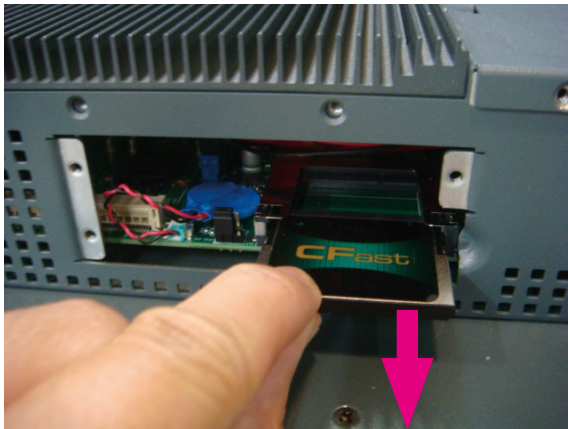
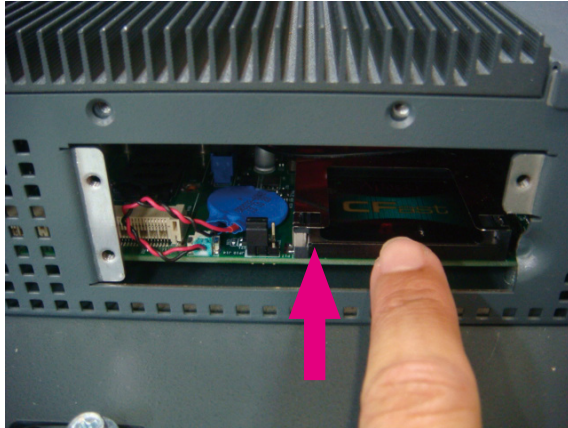

## Installing a Mini-PCle Module

The Mini-PCle module package includes the following items:  
RALINK 802.11b/g/n 2T2R wireless mini card module kit QCOM: Q802XKN5F

Mini-PCle Module



RF-Cable



Antenna



3.5G module kit Sierra Wireless MC8705





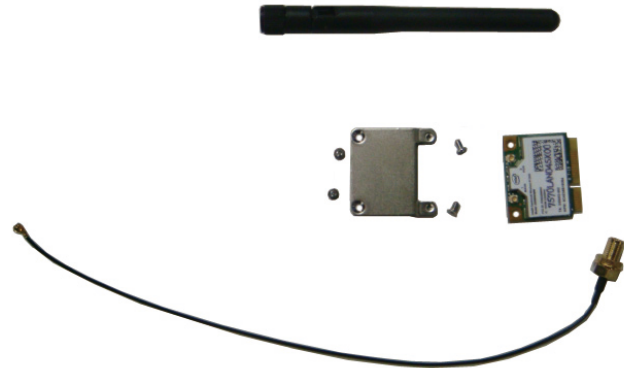



802.11b/g/n wireless mini card module kit INTEL:2200BNHMW



### Fieldbus Mini-PCle module



Mini PCIe Card	Connection Cable	Connector Board	
		 Dual RJ45	PROFINET EtherNet/IP EtherCAT
		 DB9	PROFIBUS
		 5-pin Connector	DeviceNet

**Universal PROFIBUS I/O Bracket**

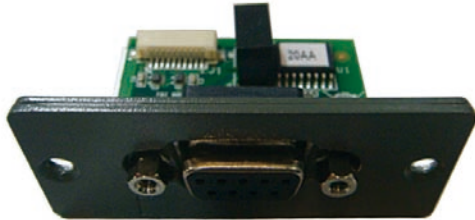

**IPPC xx60 Series Special PROFIBUS I/O Bracket**



**Universal DeviceNet I/O Bracket**



**IPPC xx60 Series Special DeviceNet I/O Bracket**



**Universal PROFINET, EtherNET/IP and EtherCAT I/O Bracket**

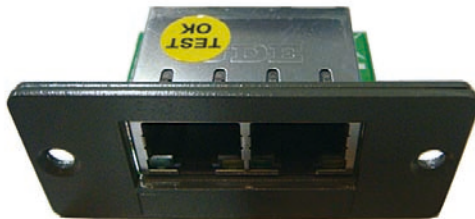

**IPPC xx60 Series Special PROFINET, EtherNET/IP and EtherCAT I/O Bracket**





If you are installing the 802.11b/g/n INTEL: 2200BNHMW mini card module (half size), before processing with the installation, please assemble the Wi-Fi module bracket first to full size module by following the instructions below:

1. Align the mounting holes on the Wi-Fi mini card module to the mounting holes on the Wi-Fi module bracket.

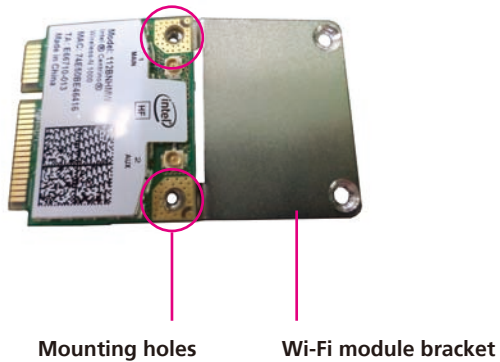

2. Tighten screws onto the mounting holes to secure the bracket.



3. Insert the Mini-PCle module into the Mini-PCle slot at the 45 degrees angle until the gold-plated connector on the edge of the module completely disappears inside the slot.

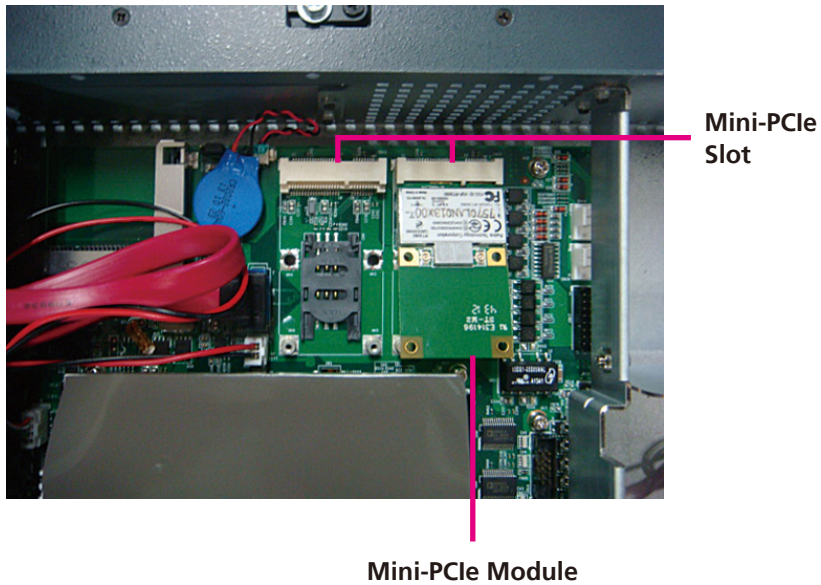

4. Secure the module with mounting screws.

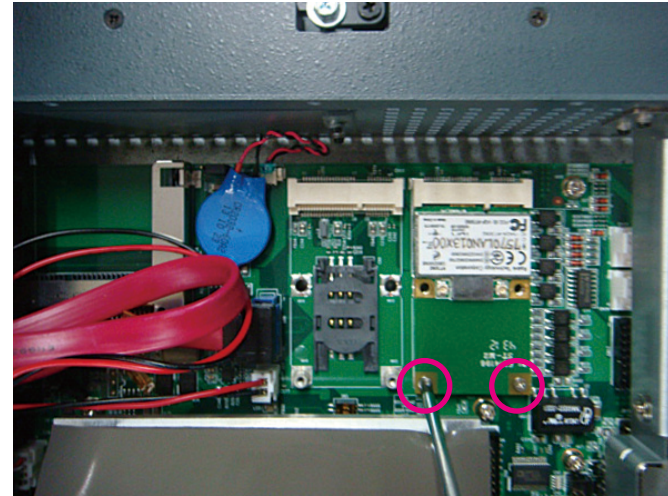

5. Wi-Fi or 3G Mini-PCle module:

A. Remove the left back cover.

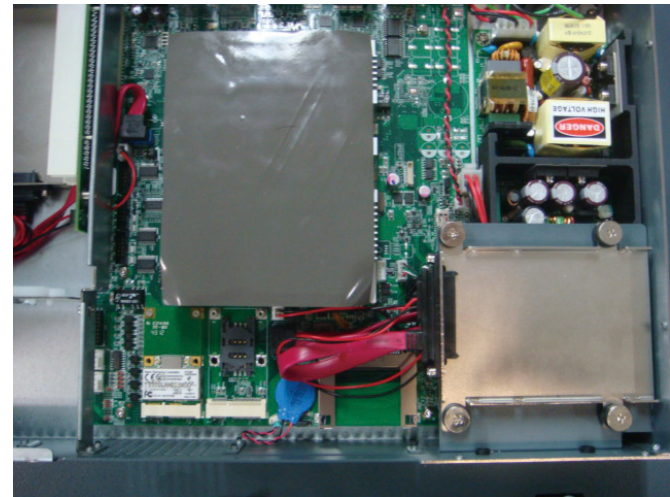
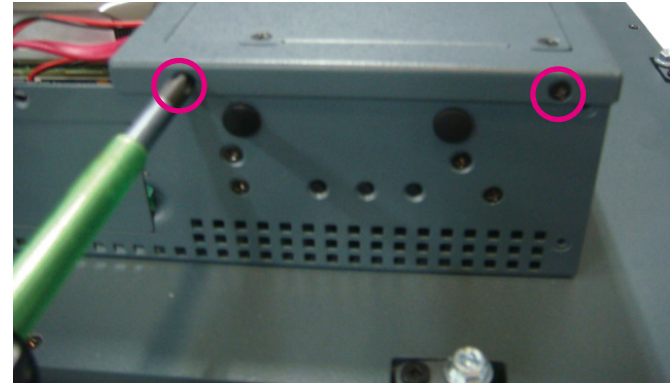
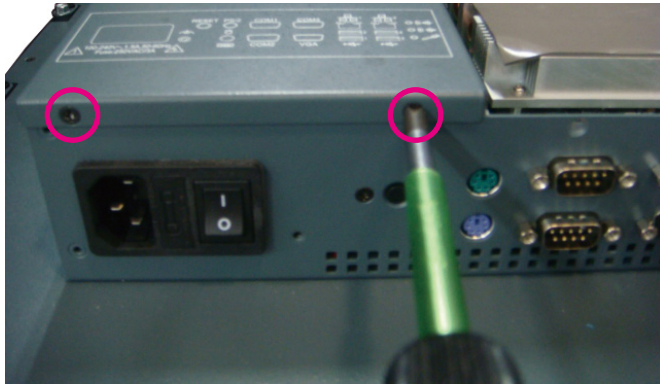

B. Attach one end of the RF cables onto the module.

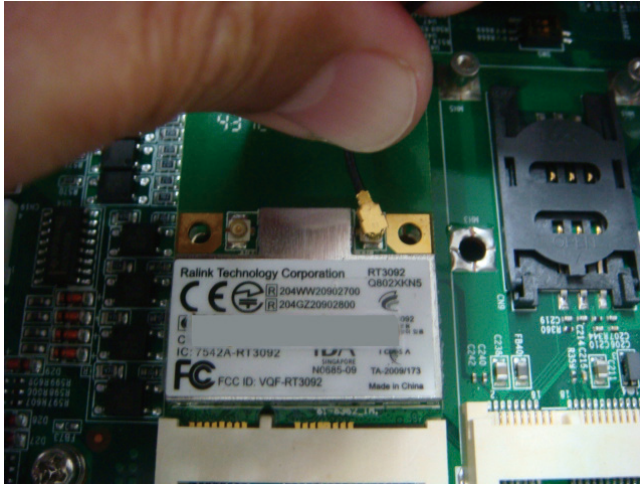

C. Remove the antenna hole block.

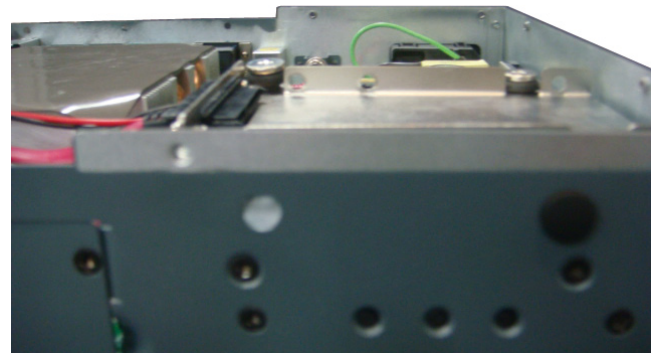
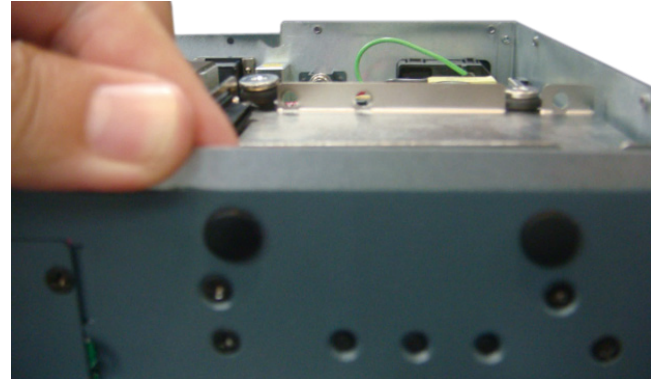



D. Insert the ring onto the antenna jack end of the cable.

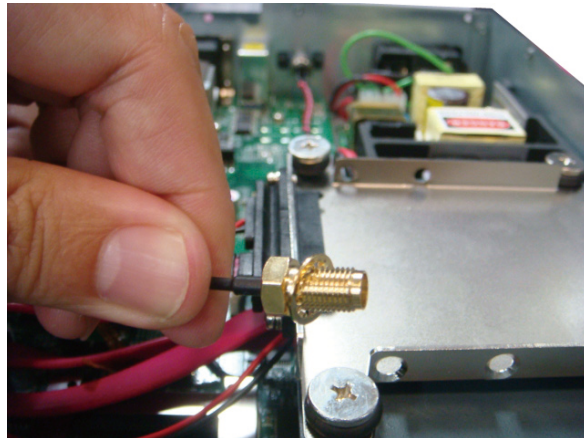
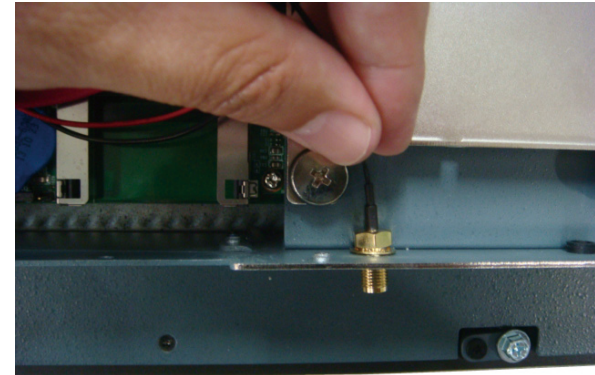
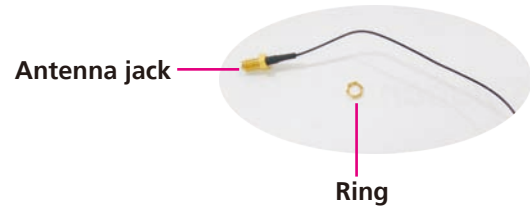

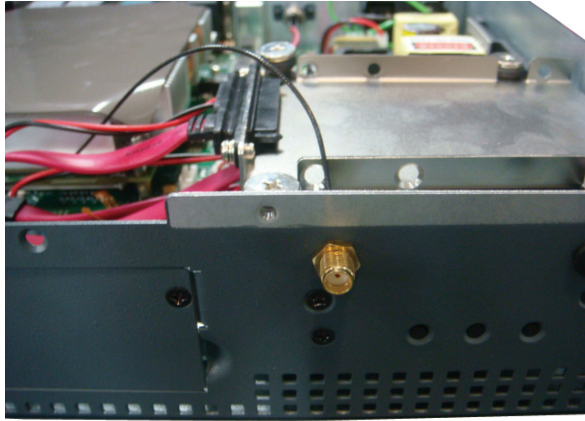

E. Connect external antennas to the antenna jacks.

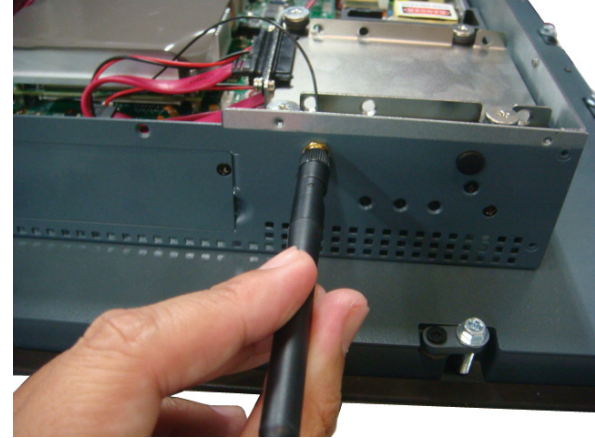

F. 3G Mini-PCIe module.

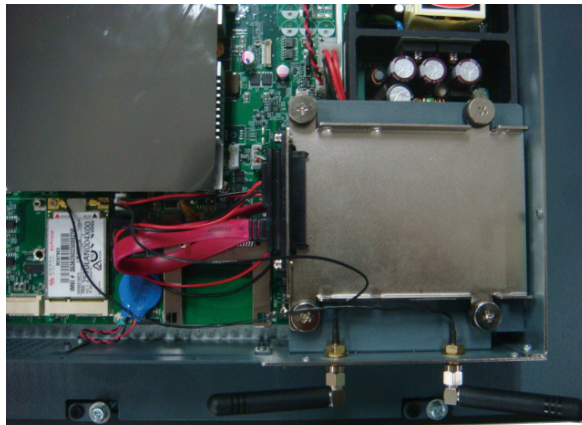
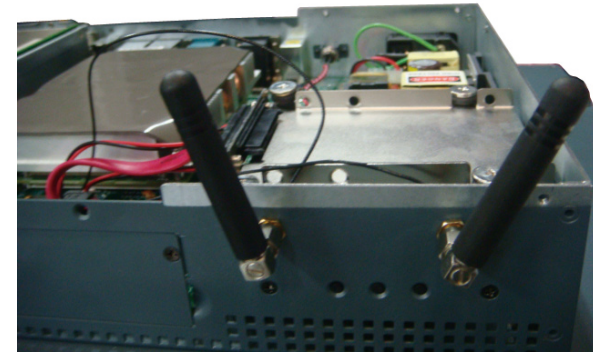

6. Fieldbus Mini-PCIe module.

A. Remove the Universal Fieldbus I/O cover or the Optional I/F cover.

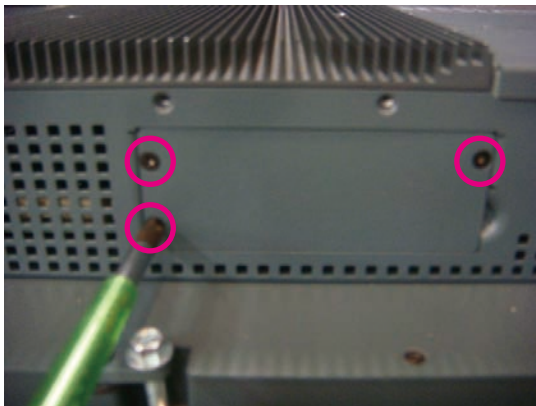
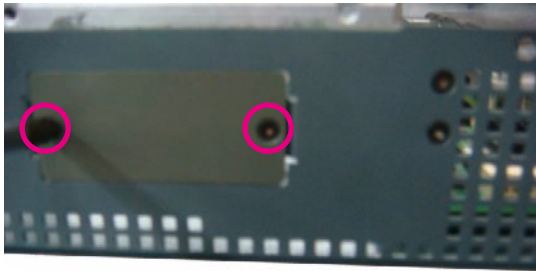

B. Secure the Universal FBI I/O bracket or the Special FBI I/O bracket.





C. Plug the FBI Cable to the I/O connector board.

**DB9 Connector Board**



**Dual RJ45 Connector Board**

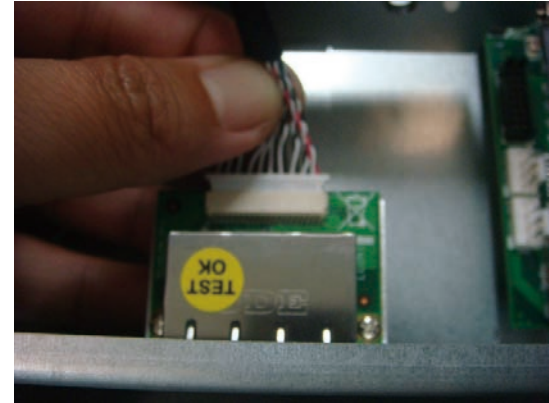

**5-pins Connector Board**



D. Plug the FBI Cable to the FBI Mini-PCle card.

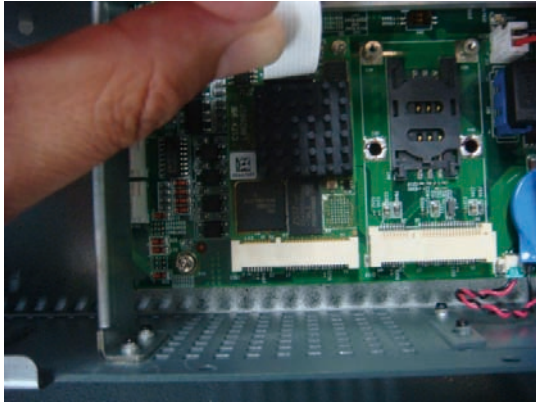

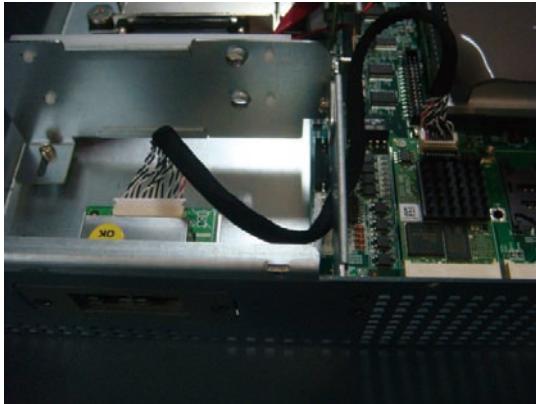

E. Stick the FBI protocol labels to the corresponding interfaces.

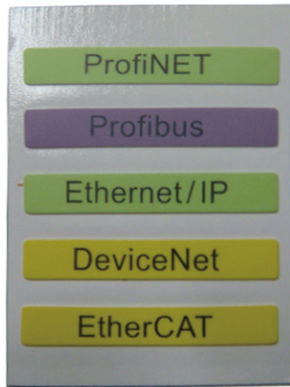

## Installing a Riser Card

The riser card package includes the following items:

### 1 PCI and 1 PCIe x4 (Default Installation)

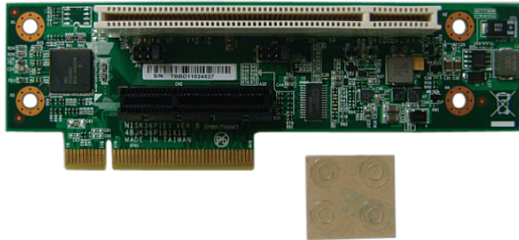

### 2 PCI riser card

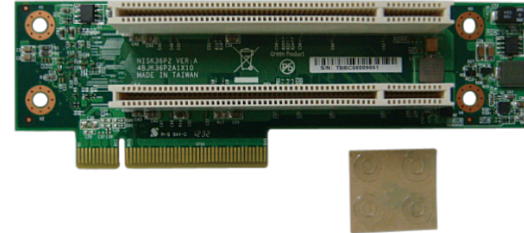

### 2 PCIe x4 riser card





1. Remove the 6 screws on the back heatsink cover.

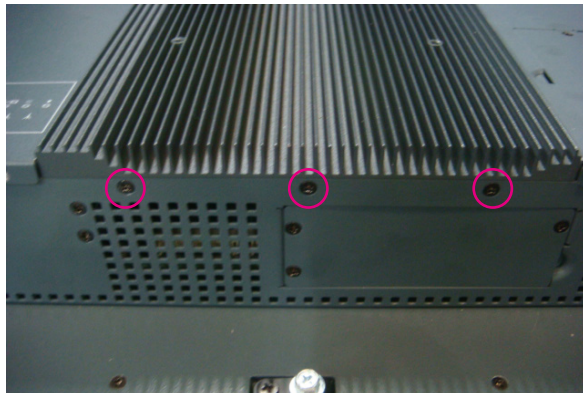
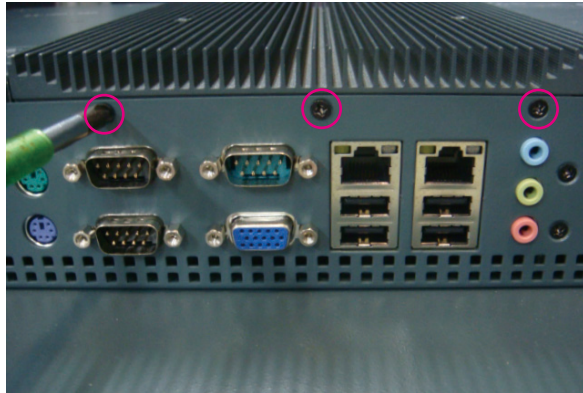

2. Remove the back heatsink cover.



3. Remove the right back cover.

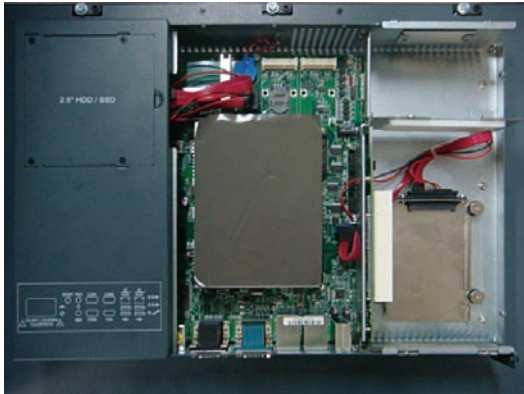

4. Remove the 4 plastic screws.

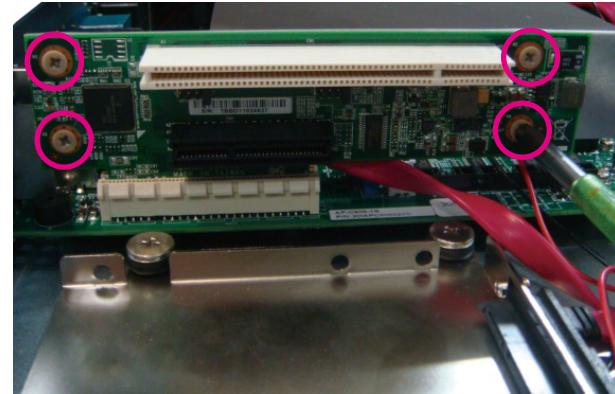

5. Pull up to remove the riser card.

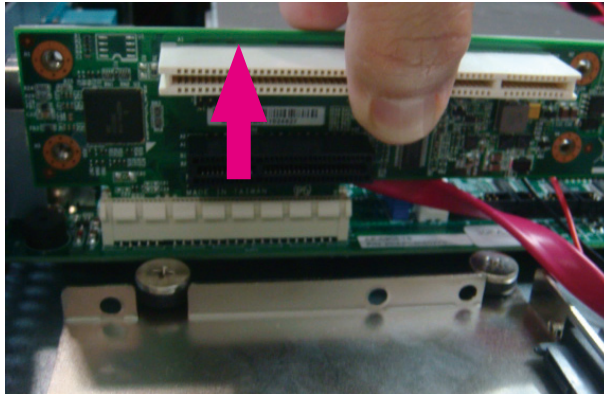

6. Attach the insulation pads to the holes on the riser card.

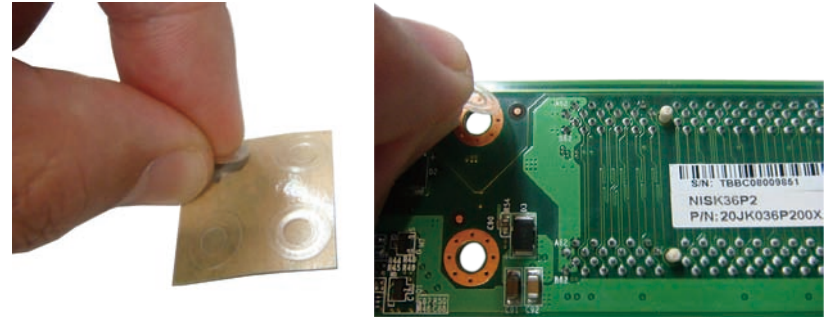



7. Plug in the 2 PCI riser card.

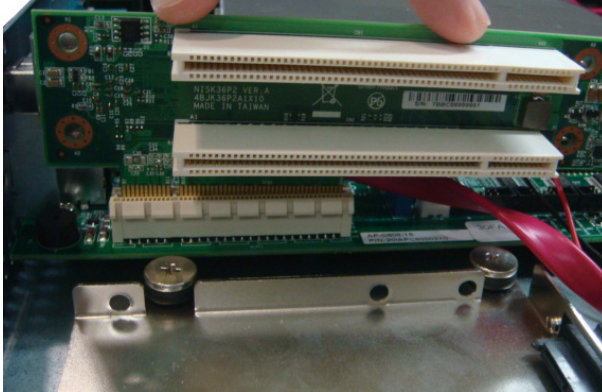

8. Use the plastic screws to secure the riser card.

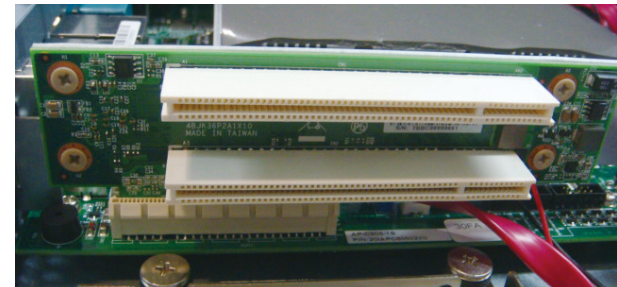
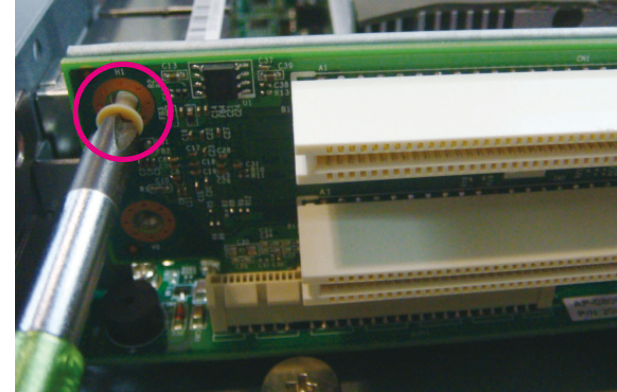

NOTE:

- Do not overtighten the plastic to prevent damaging the plastic screws.
- The plastic screw and insulation pads support GPE (ground protection earth) which means signal ground and chassis ground (earth ground) are separated.

## Installing a PCI Card

1. Remove the PCI bracket.

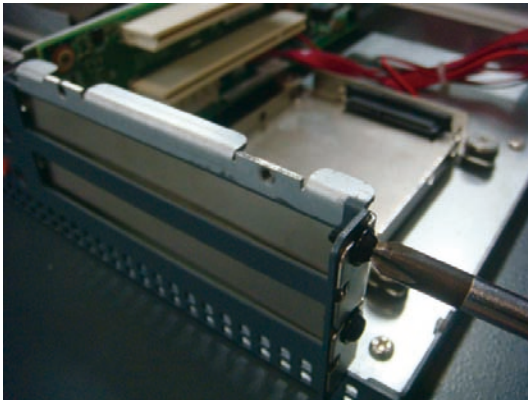

3. Secure the PCI card.



2. Plug in the PCI card.

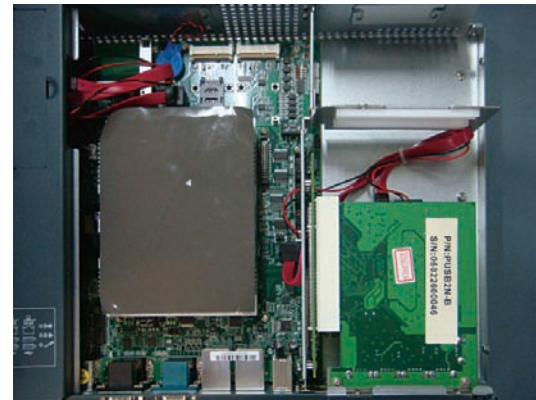
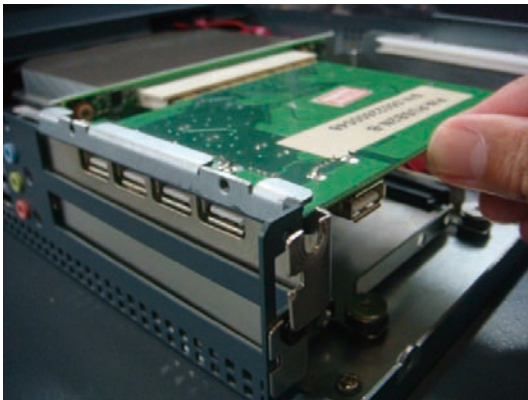

4. The PCI card bracket supports card length from 170.25 to 179.75mm. It protects the PCI card from vibration.

Move the PCI card bracket to fix the PCI card.

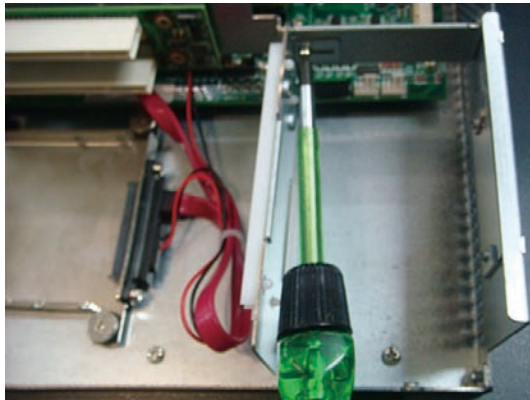
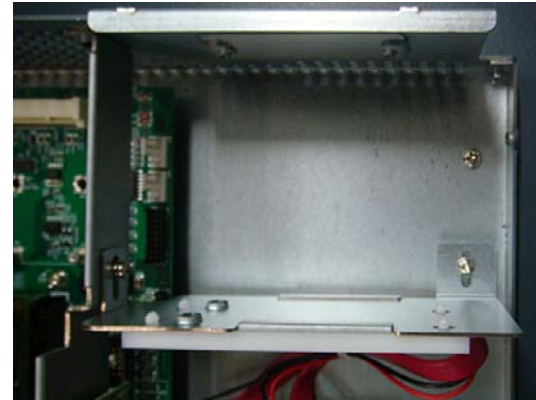
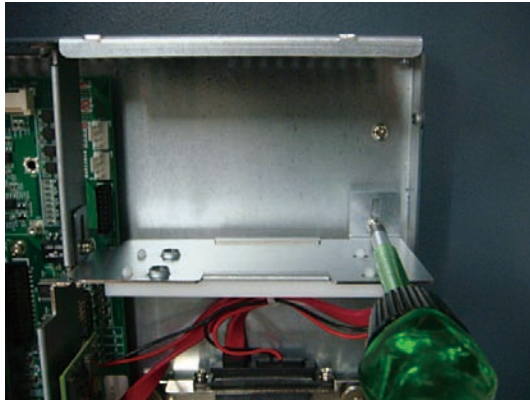

## Installing a CPU and SO-DIMM

1. Remove the thermal pad on the CPU heatsink.



2. Remove the CPU heatsink.

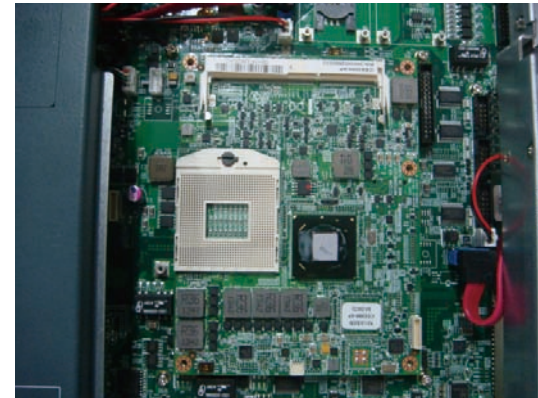
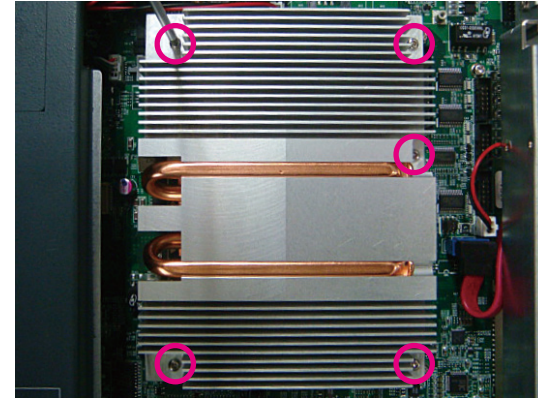



3. Insert the module into the socket at an approximately 30 degree angle. Apply firm even pressure to each end of the module until it slips into the socket. The gold-plated connector on the edge of the module will almost completely disappear inside the socket.



4. Insert the CPU into the FCPGA988 socket.



5. Turn the screw-lock counter clockwise to secure the CPU.



6. Place the thermal pads onto the bottom of the CPU heatsink.

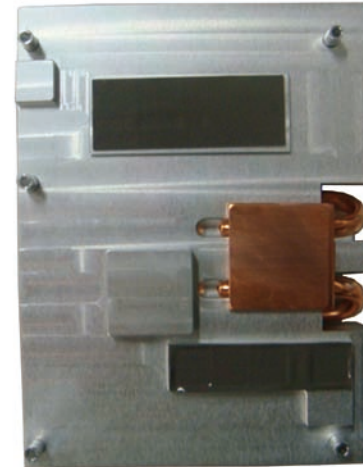

7. Place the thermal pads on the CPU and PCH IC (Intel HM76 Express Chipset).

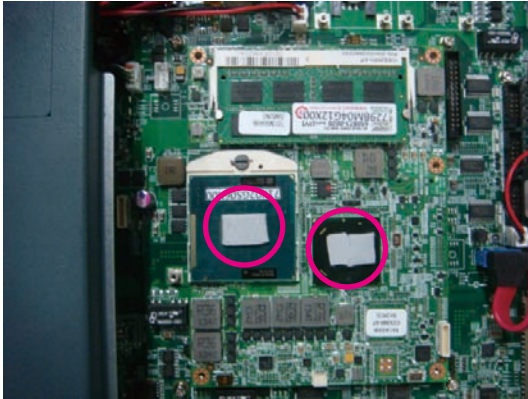

8. Secure the CPU heatsink then stick the CPU thermal pad on top.



NOTE: Please make sure the glossy side of the CPU thermal pad is facing up.

## Panel Mounting

1. Select a place on the panel where you will mount the panel PC.
2. Cut out a shape on the panel that corresponds to the panel PC's rear dimensions.

The thickness of the panel (e.g. steel board, plank, acrylic board, wall, etc.) where you will mount the Panel PC must not exceed 5mm for IPPC 1960T series, 4mm for IPPC 1560T series, and 12mm for IPPC 2160P. If the distance between the front bezel and panel mount hole is too wide, it will not fit the panel mount kit.

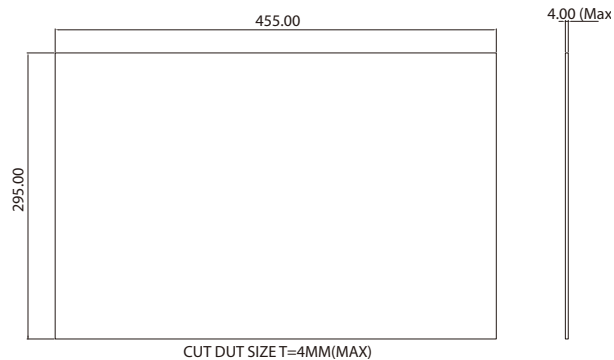

**IPPC 1560T Series**



Suitable for mounting on the flat surface of Type 2 and Type 4X indoor use only enclosure.

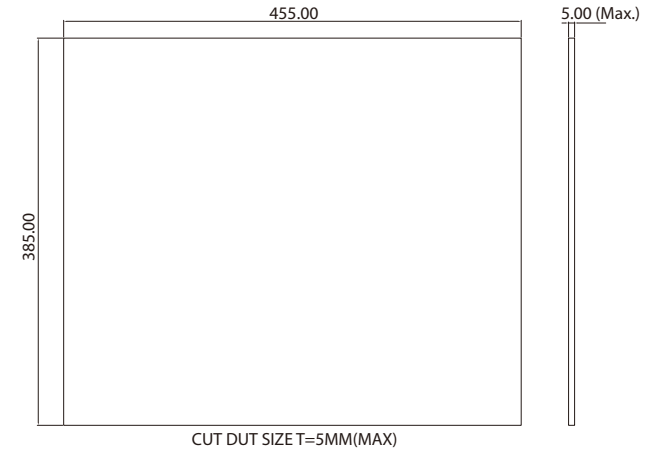

**IPPC 1960T Series**



**IPPC 2160P**



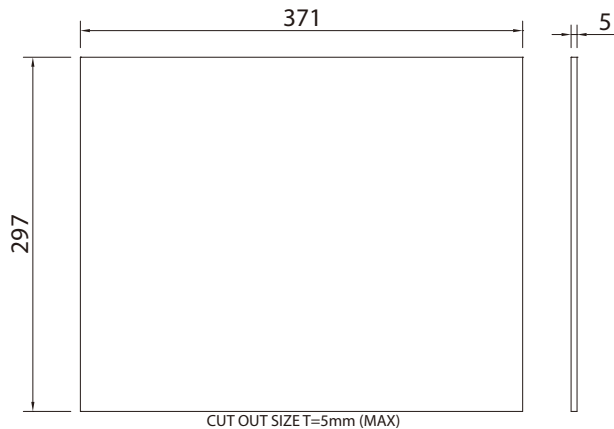

**APPC 1560T**

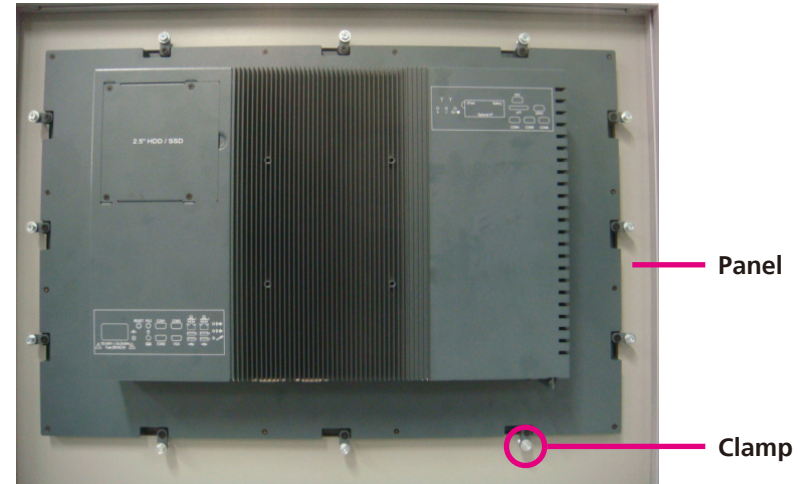

- Slide the panel PC through the hole until it is properly fitted against the panel.
- Position the mounting clamps along the rear edges of the Panel PC. The first and second clamps must be positioned and secured diagonally prior to mounting the rest of the clamps. Tighten the clamp's screw until it touches the panel.

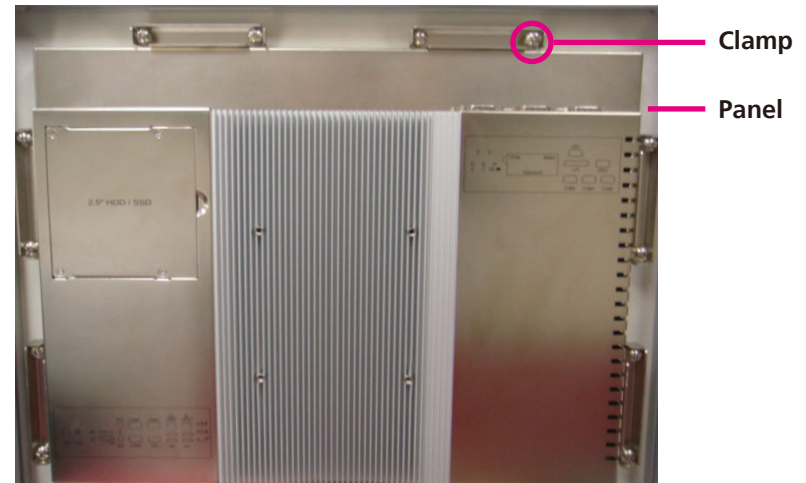

Do not overtighten the screws to prevent damaging the Panel PC.

# Chapter 4: BIOS Setup

This chapter describes how to use the BIOS setup program for the IPPC 1560T/1960T/2160P series and APPC 1560T. The BIOS screens provided in this chapter are for reference only and may change if the BIOS is updated in the future.

To check for the latest updates and revisions, visit the NEXCOM Web site at [www.nexcom.com.tw](http://www.nexcom.com.tw).

## About BIOS Setup

The BIOS (Basic Input and Output System) Setup program is a menu driven utility that enables you to make changes to the system configuration and tailor your system to suit your individual work needs. It is a ROM-based configuration utility that displays the system's configuration status and provides you with a tool to set system parameters.

These parameters are stored in non-volatile battery-backed-up CMOS RAM that saves this information even when the power is turned off. When the system is turned back on, the system is configured with the values found in CMOS.

With easy-to-use pull down menus, you can configure such items as:

- Hard drives, diskette drives, and peripherals
- Video display type and display options
- Password protection from unauthorized use
- Power management features

The settings made in the setup program affect how the computer performs. It is important, therefore, first to try to understand all the setup options, and second, to make settings appropriate for the way you use the computer.

## When to Configure the BIOS

- This program should be executed under the following conditions:
- When changing the system configuration
- When a configuration error is detected by the system and you are prompted to make changes to the setup program
- When resetting the system clock
- When redefining the communication ports to prevent any conflicts
- When making changes to the Power Management configuration
- When changing the password or making other changes to the security setup

Normally, CMOS setup is needed when the system hardware is not consistent with the information contained in the CMOS RAM, whenever the CMOS RAM has lost power, or the system features need to be changed.

## Default Configuration

Most of the configuration settings are either predefined according to the Load Optimal Defaults settings which are stored in the BIOS or are automatically detected and configured without requiring any actions. There are a few settings that you may need to change depending on your system configuration.

## Entering Setup











When the system is powered on, the BIOS will enter the Power-On Self Test (POST) routines. These routines perform various diagnostic checks; if an error is encountered, the error will be reported in one of two different ways:

- If the error occurs before the display device is initialized, a series of beeps will be transmitted.
- If the error occurs after the display device is initialized, the screen will display the error message.

Powering on the computer and immediately pressing <Del> allows you to enter Setup. Another way to enter Setup is to power on the computer and wait for the following message during the POST:

Press the  key to enter Setup:

## Legends

Key	Function
	Moves the highlight left or right to select a menu.
	Moves the highlight up or down between sub-menus or fields.
	Exits the BIOS Setup Utility.
	Scrolls forward through the values or options of the highlighted field.
	Scrolls backward through the values or options of the highlighted field.
	Selects a field.
	Displays General Help.
	Load previous values.
	Load optimized default values.
	Saves and exits the Setup program.
	Press <Enter> to enter the highlighted sub-menu

## Scroll Bar

When a scroll bar appears to the right of the setup screen, it indicates that there are more available fields not shown on the screen. Use the up and down arrow keys to scroll through all the available fields.

## Submenu

When “▶” appears on the left of a particular field, it indicates that a submenu which contains additional options are available for that field. To display the submenu, move the highlight to that field and press  .

## BIOS Setup Utility

Once you enter the AMI BIOS Setup Utility, the Main Menu will appear on the screen. The main menu allows you to select from several setup functions and one exit. Use arrow keys to select among the items and press  to accept or enter the submenu.

### Main

The Main menu is the first screen that you will see when you enter the BIOS Setup Utility.

### System Date

The date format is <day>, <month>, <date>, <year>. Day displays a day, from Monday to Sunday. Month displays the month, from January to December. Date displays the date, from 1 to 31. Year displays the year, from 1999 to 2099.

### System Time

The time format is <hour>, <minute>, <second>. The time is based on the 24-hour military-time clock. For example, 1 p.m. is 13:00:00. Hour displays hours from 00 to 23. Minute displays minutes from 00 to 59. Second displays seconds from 00 to 59.

Aptio Setup Utility - Copyright (C) 2011 American Megatrends, Inc.					
Main	Advanced	Chipset	Boot	Security	Save & Exit
<b>BIOS Information</b>		American Megatrends		Set the Time. Use Tab to switch between Time elements.	
BIOS Vendor	4.6.5.3				
Core Version	UEFI 2.3; PI 1.2				
Compliancy	I268A012				
Project Version	07/16/2013 09:59:33				
Build Date and Time					
<b>Memory Information</b>		1600 Mhz			
Memory Frequency	4096 MB (DDR3)				
Total Memory	4096 MB (DDR3)				
DIMM#0	Not Present				
DIMM#2					
<b>ME Firmware Information</b>		8.0.3.1427		←→: Select Screen	
ME FW Version	Normal Mode		↑↓: Select Item		
ME Firmware Mode	5MB		Enter: Select		
ME Firmware SKU			+/-: Change Opt.		
			F1: General Help		
			F2: Previous Values		
			F3: Optimized Defaults		
			F4: Save & Exit		
			ESC: Exit		
<b>System Date</b>	[Fri 01/23/2009]				
<b>System Time</b>	[04:42:17]				
Version 2.14.1219. Copyright (C) 2011 American Megatrends, Inc.					

## Advanced

The Advanced menu allows you to configure your system for basic operation. Some entries are defaults required by the system board, while others, if enabled, will improve the performance of your system or let you set some features according to your preference.



Setting incorrect field values may cause the system to malfunction.

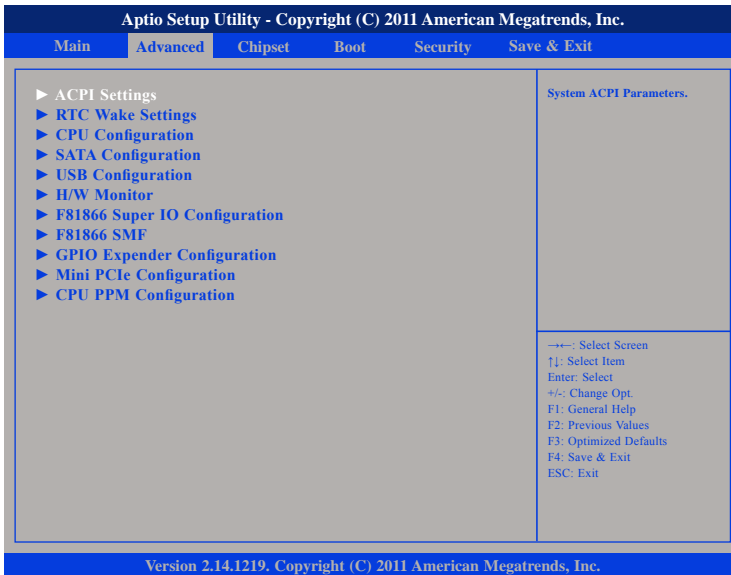

## ACPI Settings

This section is used to configure ACPI Settings.

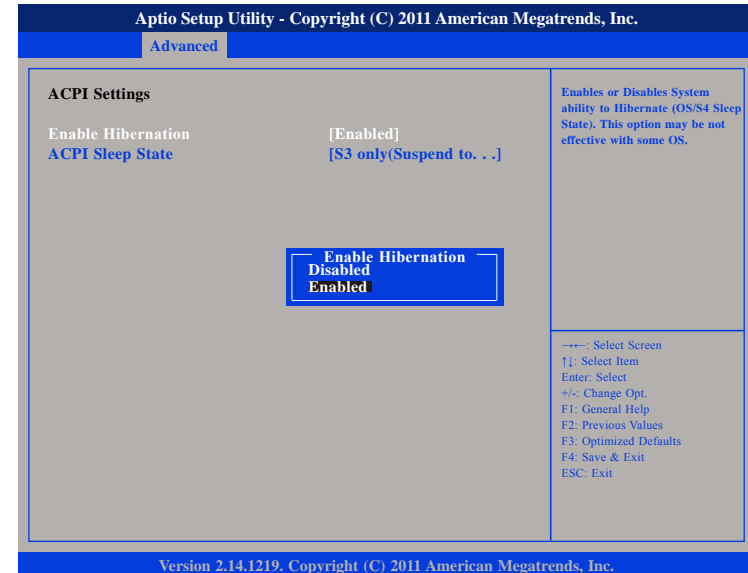

### Enable Hibernation

Enables or disables system ability to hibernate (OS/S4 Sleep State). This option may not be effective with some OS.

## ACPI Sleep State



Select the highest ACPI sleep state the system will enter when the suspend button is pressed. The options are Suspend Disabled, S1 (CPU Stop Clock) and S3 (Suspend to RAM).

## RTC Wake Settings

This section is used to configure S5 RTC Wake Settings.

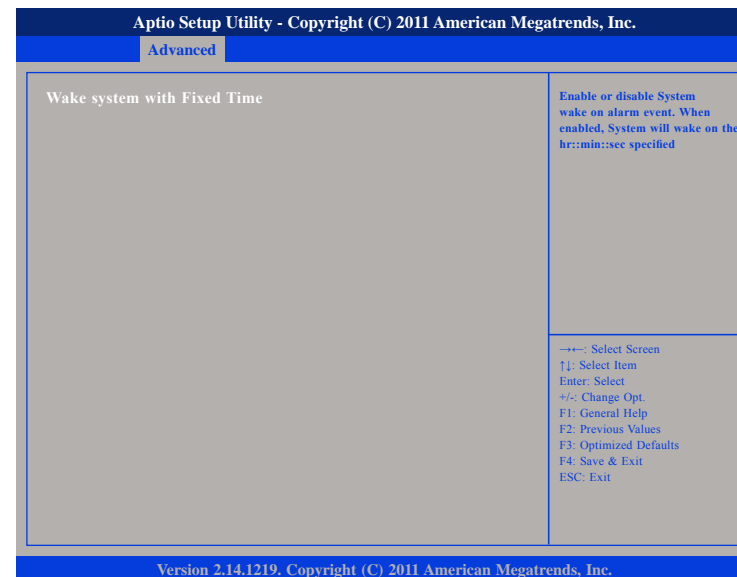

### Wake System with Fixed Time

Enables or disables system wake on alarm event. When enabled, system will wake on the hr::min::sec specified.

## CPU Configuration

This section is used to configure the CPU.

Aptio Setup Utility - Copyright (C) 2011 American Megatrends, Inc.

Advanced

<b>CPU Configuration</b>		Enabled for Windows XP and Linux (OS optimized for Hyper-Threading Technology) and Disabled for other OS (OS not optimized for Hyper-Threading Technology). When Disabled only one thread per enabled core is enabled.
Intel(R) Core(TM) CPU i5-3610ME CPU @ 2.70GHz		
CPU Signature	306a9	
Microcode Patch	12	
CPU Speed	2700 MHz	
Processor Cores	2	
Intel HT Technology	Supported	
Intel VT-x Technology	Supported	
Intel SMX Technology	Supported	
64-bit	Supported	
Hyper-threading	[Enabled]	
Intel Virtualization Technology	[Disabled]	

→←: Select Screen  
↑↓: Select Item  
Enter: Select  
+/-: Change Opt.  
F1: General Help  
F2: Previous Values  
F3: Optimized Defaults  
F4: Save & Exit  
ESC: Exit

Version 2.14.1219. Copyright (C) 2011 American Megatrends, Inc.

### Hyper Threading

Enables or disables hyper-threading technology.

### Intel® Virtualization Technology

Enables or disables Intel® Virtualization technology.

## SATA Configuration

This section is used to configure the SATA drives.

Aptio Setup Utility - Copyright (C) 2011 American Megatrends, Inc.

Advanced

<b>SATA Controller(s)</b>	[Enabled]	Enable or disable SATA Device.
<b>SATA Mode Selection</b>	[IDE]	
<b>Serial ATA Port 0</b>	Empty	
Software Preserve	Unknown	
<b>Serial ATA Port 1</b>	Empty	
Software Preserve	Unknown	
<b>Serial ATA Port 2</b>	8GB SATA Flash (8.0GB)	
Software Preserve	SUPPORTED	
<b>Serial ATA Port 3</b>	Empty	
Software Preserve	Unknown	

→←: Select Screen  
↑↓: Select Item  
Enter: Select  
+/-: Change Opt.  
F1: General Help  
F2: Previous Values  
F3: Optimized Defaults  
F4: Save & Exit  
ESC: Exit

Version 2.14.1219. Copyright (C) 2011 American Megatrends, Inc.

### SATA Controller(s)

Enables or disables SATA device.

### Serial ATA Port 0 to Serial ATA Port 3

Displays information on the SATA devices detected.



## SATA Mode Selection



Configures the SATA as IDE, AHCI or RAID mode.

- IDE** This option configures the Serial ATA drives as Parallel ATA physical storage device.
- RAID** This option allows you to create RAID or Intel Matrix Storage configuration on Serial ATA devices.
- AHCI** This option configures the Serial ATA drives to use AHCI (Advanced Host Controller Interface). AHCI allows the storage driver to enable the advanced Serial ATA features which will increase storage performance.

## USB Configuration

This section is used to configure the USB.



### Legacy USB Support

- Enable** Enables Legacy USB.
- Auto** Disables support for Legacy when no USB devices are connected.
- Disable** Keeps USB devices available only for EFI applications.

### Port 60/64 Emulation

Enables I/O port 60h/64h emulation support. This should be enabled for complete USB keyboard legacy support for non-USB aware OSes.

## H/W Monitor

This section is used to monitor hardware status such as temperature, fan speed and voltages.

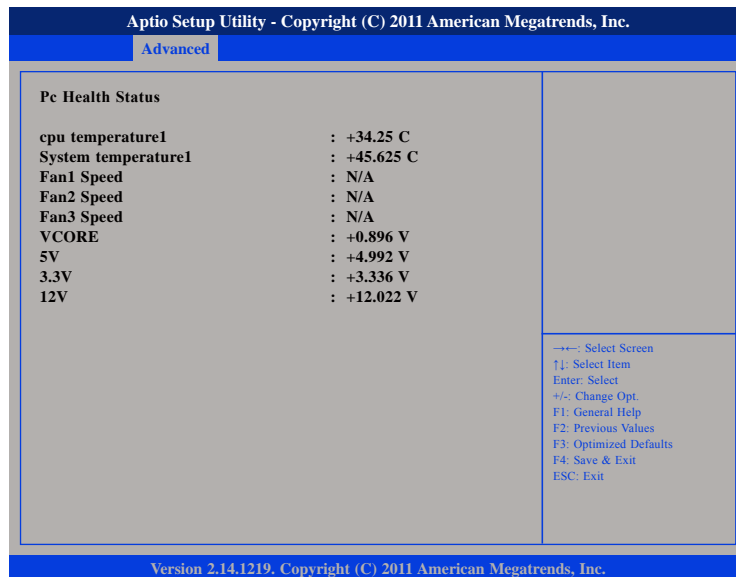

## VCORE

Detects and displays the Vcore CPU voltage.

## 5V

Detects and displays 5V voltage.

## 3.3V

Detects and displays 3.3V voltage.

## 12V

Detects and displays 12V voltage.

## CPU Temperature1

Detects and displays the current CPU temperature.

## System Temperature1

Detects and displays the current system temperature.

## Fan1 Speed to Fan3 Speed

Detects and displays the system fan1 to fan3 speeds.

## F81866 Super IO Configuration

This section is used to configure the serial ports.



### F81866 Super IO Chip

Displays the Super I/O chip used on the board.

## Serial Port 0 Configuration

This section is used to configure serial port 0.



### Serial Port

Enables or disables the serial port.

### Change Settings

Selects an optimal setting for the Super IO device.

### Onboard Serial Port 1 Mode

Select this to change the serial port mode to RS232, RS422, RS485 or RS485 Auto.

### Terminal

Enables or disables terminal high or low.

## Serial Port 1 Configuration

This section is used to configure serial port 1.

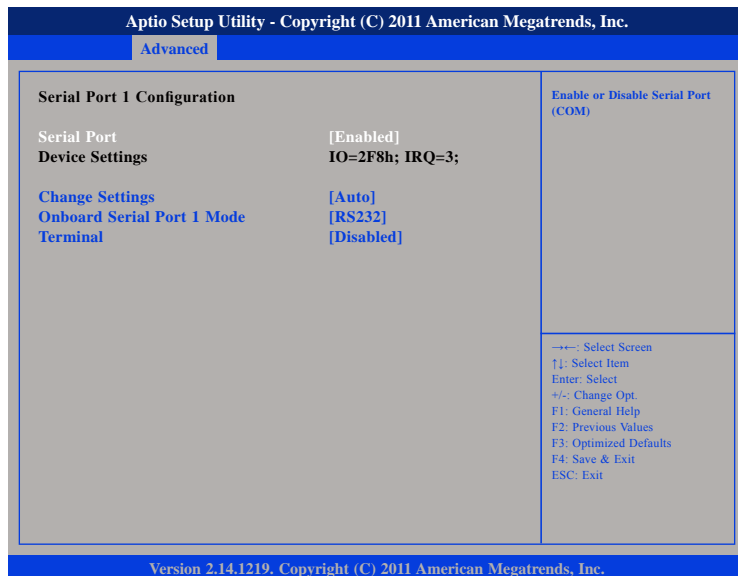

### Serial Port

Enables or disables the serial port.

### Change Settings

Selects an optimal setting for the Super IO device.

### Onboard Serial Port 1 Mode

Select this to change the serial port mode to RS232, RS422, RS485 or RS485 Auto.

### Terminal

Enables or disables terminal high or low.

## Serial Port 2 Configuration

This section is used to configure serial port 2.



### Serial Port

Enables or disables the serial port.

### Change Settings

Selects an optimal setting for the Super IO device.

## Serial Port 3 Configuration

This section is used to configure serial port 3.

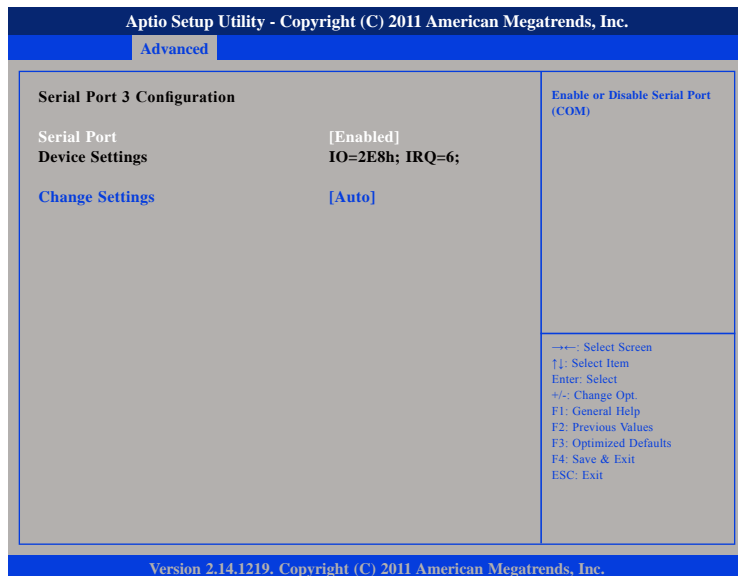

### Serial Port

Enables or disables the serial port.

### Change Settings

Selects an optimal setting for the Super IO device.

## Serial Port 4 Configuration

This section is used to configure serial port 4.

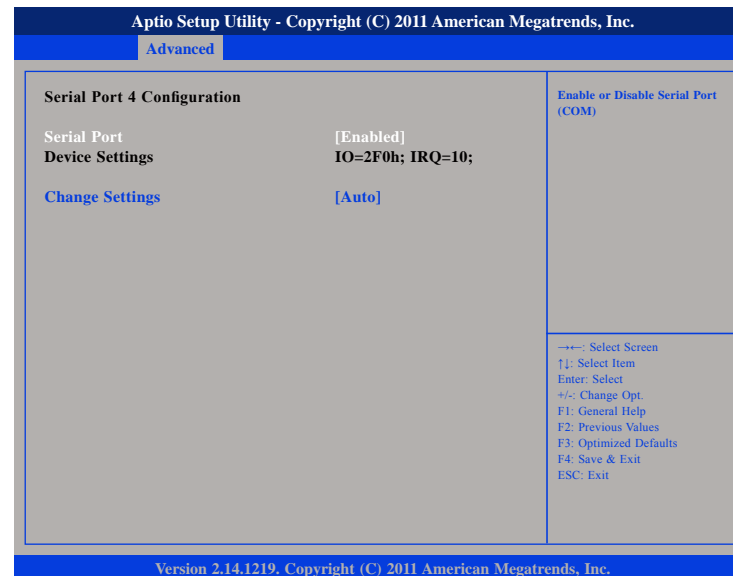

### Serial Port

Enables or disables the serial port.

### Change Settings

Selects an optimal setting for the Super IO device.

## Serial Port 5 Configuration

This section is used to configure serial port 5.



### Serial Port

Enables or disables the serial port.

### Change Settings

Selects an optimal setting for the Super IO device.

### Device Mode

Configures the operating mode of the serial port.

## Parallel Port Configuration

This section is used to configure the parallel port.



### Parallel Port

Enables or disables the parallel port.

### Change Settings

Selects an optimal setting for the Super IO device.

### Device Mode

Configures the operating mode of the parallel port.

## GPIO Expander Configuration

This section is used to configure the GPIO expander.

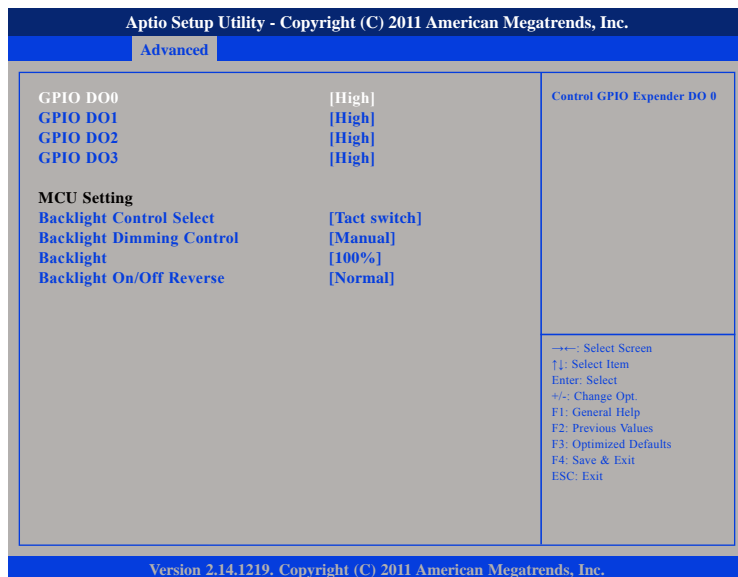

### GPIO DO0 to GPIO DO3

Configures digital output 0 to digital output 3 as high or low.

### Backlight Control Select

The available options are Pyroelectric Sensor and Tact Switch. The Backlight On/Off button is functional only in Tact Switch mode.

### Backlight Dimming Control Select

The available options are Tact Switch, Manual and Light Sensor.

When set to Tact Switch, backlight option below will not be configurable, please use the brightness button on the panel to adjust it.

### Backlight

Adjusts the brightness of the backlight.

### Backlight On/Off Reverse

Please configure this option only when changing the panel, otherwise the display may not work.

## Mini PCIe Configuration

This section is used to configure the Mini-PCIe settings.



### Mini PCIe Configuration Settings

Configures the Mini-PCIe to operate in 3G or Wi-Fi mode.

## CPU PPM Configuration

This section is used to configure the Processor Power Management (PPM) configuration.

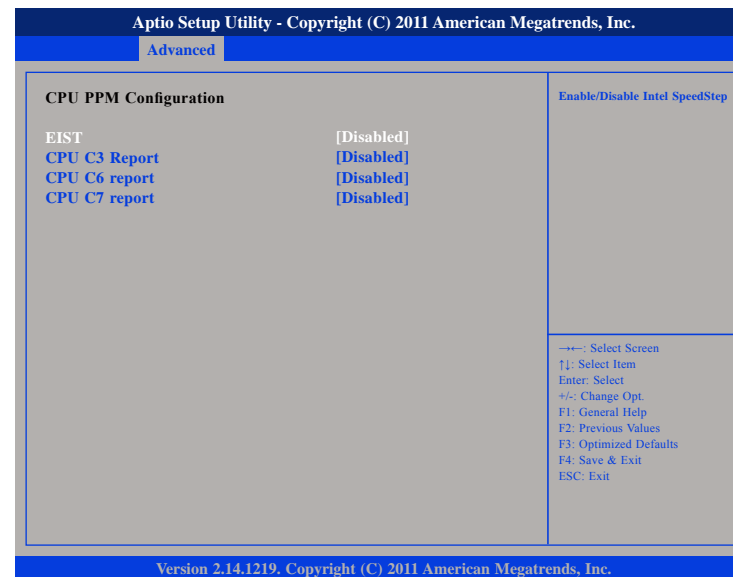

### EIST

Enables or disables Intel® SpeedStep.

### CPU C3 Report

Enables or disables C3 report to the operating system.

### CPU C6 Report

Enables or disables C6 report to the operating system.

### CPU C7 Report

Enables or disables C7 report to the operating system.



## Chipset

This section gives you functions to configure the system based on the specific features of the chipset. The chipset manages bus speeds and access to system memory resources.



### PCH-IO Configuration

PCH-IO parameters.

### System Agent (SA) Configuration

System Agent (SA) parameters.

## PCH-IO Configuration

This section is used to configure PCH-IO configuration.

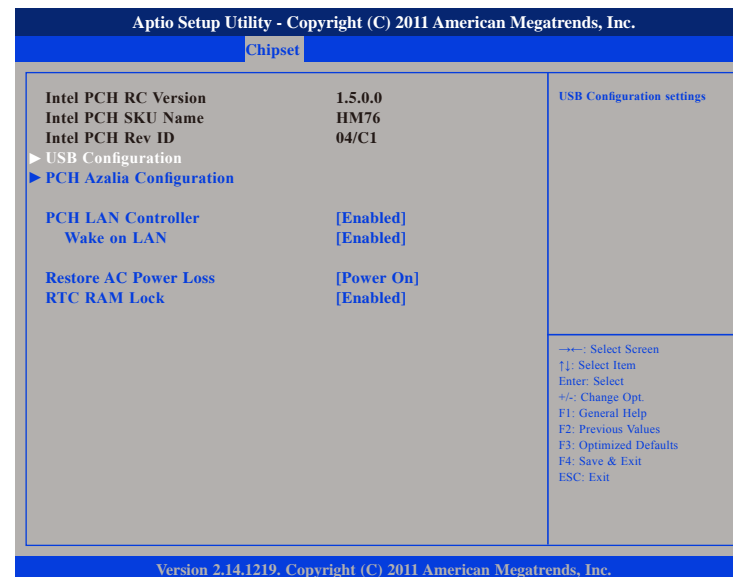

### PCH LAN Controller

Enables or disables onboard NIC.

### Wake on LAN

Enables or disables integrated LAN to wake the system.

### Restore AC Power Loss

Select AC power state when power is re-applied after a power failure.

### RTC RAM Lock

Enables or disables bytes 38h-3Fh in the upper and lower 128-byte bank of RTC RAM lockdown.

## USB Configuration



### EHCI1 and EHCI2

Enables or disables the Enhanced Host Controller Interface (USB 2.0), one EHCI controller must always be enabled.

## PCH Azalia Configuration



### Azalia

Control detection of the Azalia device.

Disabled Azalia will be unconditionally disabled.  
Enabled Azalia will be unconditionally disabled.

## System Agent (SA) Configuration

This section is used to configure the System Agent (SA) configuration.



### VT-d

Enables or disables VT-d function on MCH.

## Graphics Configuration

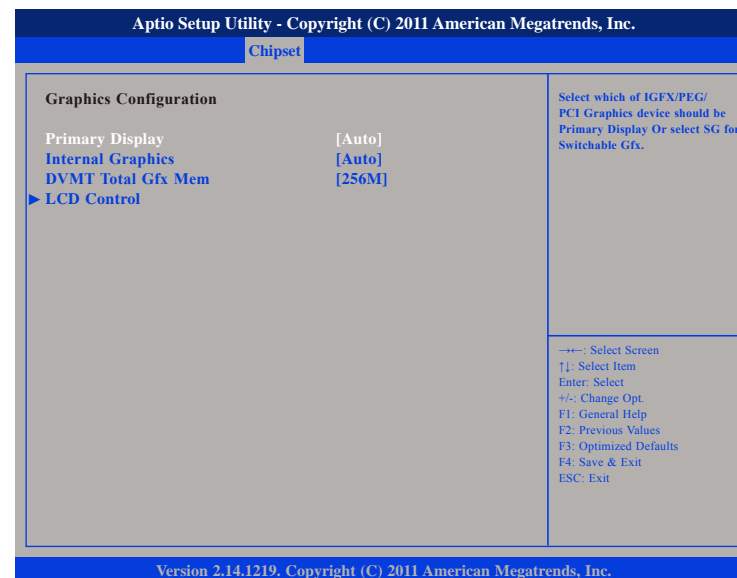

### Primary Display

Select which of IGFX/PEG/PCI graphics device should be primary display or select SG for switchable Gfx.

### Internal Graphics

Keep IGD enabled based on the setup options.

### DVMT Total Gfx Mem

Selects DVMT5.0 Total Graphic Memory size used by the Internal Graphics Device.

## LCD Control



### Primary IGFX Boot Display

Select the video device which will be activated during POST. Has no effect if external graphics is present. Secondary boot display selection will appear based on your selection. VGA modes will be supported only on primary display.

### Secondary IGFX Boot Display

Select the secondary display device.

### Active LFP

Select the Active LFP configuration.

No LVDS	VBIOS does not enable LVDS.
Int-LVDS	VBIOS enables LVDS driver by Integrated encoder.

## NB PCIe Configuration

This section is used to configure Northbridge PCI Express settings.

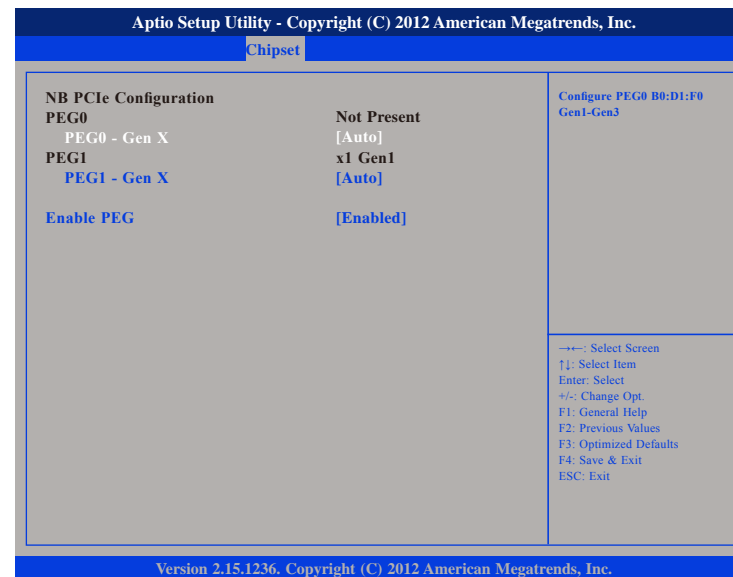

### PEG0 - Gen X

Configure PEG0 B0:D1:F0 Gen1-Gen3.

### PEG1 - Gen X

Configure PEG1 B0:D1:F1 Gen1-Gen3.

### Enable PEG

Enables or disables the PEG slot.

## Boot

This section is used to configure the boot features.



### Quiet Boot

Enabled Displays OEM logo instead of the POST messages.  
 Disabled Displays normal POST messages.

### Launch PXE OpROM Policy

Controls the execution of UEFI and legacy PXE OpROM.

## Boot Option Priorities

Adjust the boot sequence of the system. Boot Option #1 is the first boot device that the system will boot from, next will be #2 and so forth.

### Boot Option #1



Sets the system boot order.

## Hard Drive BBS Priorities

Sets the order of the legacy devices in this group.



## Security

Aptio Setup Utility - Copyright (C) 2011 American Megatrends, Inc.					
Main	Advanced	Chipset	Boot	Security	Save & Exit
<p><b>Password Description</b></p> <p>If <b>ONLY</b> the Administrator's password is set, then this only limits access to Setup and is only asked for when entering Setup. If <b>ONLY</b> the User's password is set, then this is a power on password and must be entered to boot or enter Setup. In Setup the User will have Administrator rights. The password length must be in the following range:</p> <p>Minimum length                    3 Maximum length                    20</p> <p>Administrator Password User Password</p>		<p>Set Administrator Password</p>			
		<p>→←: Select Screen ↑↓: Select Item Enter: Select +/-: Change Opt. F1: General Help F2: Previous Values F3: Optimized Defaults F4: Save &amp; Exit ESC: Exit</p>			
Version 2.14.1219. Copyright (C) 2011 American Megatrends, Inc.					

### Administrator Password

Select this to reconfigure the administrator's password.

### User Password

Select this to reconfigure the user's password.

## Save & Exit

Aptio Setup Utility - Copyright (C) 2011 American Megatrends, Inc.					
Main	Advanced	Chipset	Boot	Security	Save & Exit
<p>Save Changes and Reset Discard Changes and Reset</p> <p>Restore Defaults</p>		<p>Reset the system after saving the changes.</p>			
		<p>→←: Select Screen ↑↓: Select Item Enter: Select +/-: Change Opt. F1: General Help F2: Previous Values F3: Optimized Defaults F4: Save &amp; Exit ESC: Exit</p>			
Version 2.14.1219. Copyright (C) 2011 American Megatrends, Inc.					

### Save Changes and Reset

To save the changes and reset, select this field then press <Enter>. A dialog box will appear. Confirm by selecting Yes.

### Discard Changes and Reset

To exit the Setup utility without saving the changes, select this field then press <Enter>. You may be prompted to confirm again before exiting.

### Restore Defaults

To restore the BIOS to default settings, select this field then press <Enter>. A dialog box will appear. Confirm by selecting Yes.

# Appendix A: GPIO Programming Guide

GPIO (General Purpose Input/Output) pins are provided for custom system design. This appendix provides definitions and its default setting for the ten GPIO pins in the IPPC 1560T/1960T/2160P series. The pin definition is shown in the following table:

Pin	GPIO mode	PowerOn Default	Address	Pin	GPIO mode	PowerOn Default	Address
1	VCC	-	-	2	GND	-	-
3	GPO0	High	538h (Bit3)	4	GPIO	High	50Fh (Bit0)
5	GPO1	High	538h (Bit6)	6	GPI1	High	538h (Bit4)
7	GPO2	High	538h (Bit7)	8	GPI2	High	538h (Bit5)
9	GPO3	High	53Ah (Bit1)	10	GPI3	High	53Bh (Bit1)

The bit is Set/Clear indicated output High/Low



## GPIO programming sample code

```
#define GPIO_PORT    0x538
#define GPO0        (0x01 << 3)
#define GPO1        (0x01 << 6)
#define GPO2        (0x01 << 7)

#define GPO0_HI      outportb(GPIO_PORT, 0x08)
#define GPO0_LO      outportb(GPIO_PORT, 0x00)
#define GPO1_HI      outportb(GPIO_PORT, 0x40)
#define GPO1_LO      outportb(GPIO_PORT, 0x00)
#define GPO2_HI      outportb(GPIO_PORT, 0x80)
#define GPO2_LO      outportb(GPIO_PORT, 0x00)

void main(void)
{
    GPO0_HI;
    GPO1_LO;
    GPO2_HI;
}
```

# Appendix B: Watchdog Timer Setting

## WatchDog Programming Guide

```

#define SUPERIO_PORT 0x2E
#define WDT_SET      0xF5
#define WDT_VALUE    0xF6
#define WDT_SET2     0xFA

void main(void)
{
    # Enter SuperIO Configuration
    outportb(SUPERIO_PORT, 0x87);
    outportb(SUPERIO_PORT, 0x87);

    # Set LDN
    outportb(SUPERIO_PORT,0x07);
    outportb(SUPERIO_PORT+1 ,0x07);

    # clear WDT status
    outportb(SUPERIO_PORT, WDT_SET
    outportb(SUPERIO_PORT+1, 0x40)
    outportb(SUPERIO_PORT, WDT_SET2
    outportb(SUPERIO_PORT+1, 0xD1)

    # Set WDT setting
    outportb(SUPERIO_PORT, WDT_SET);
    outportb(SUPERIO_PORT+1, 0x20);           # Use the second to come down
                                              # If choose the Minute, change value to 0x28

    # Set WDT sec/min
    outportb(SUPERIO_PORT, WDT_VALUE);
    outportb(SUPERIO_PORT+1, 0x05);         #Set 5 seconds
}

```